

SEATING

PRICELIST

Valid from 1<sup>st</sup> January 2023

2023

**PEDRALI**<sup>®</sup>

**PEDRALI®**



# Seatings, fittings and show-room displayers index

Indice sedute, accessori e espositori per show-room

## SEATING / SEDUTE

Allure	024	Frida	097
Ara	024	Glam	098
Arki-Bench	026	Gliss	100
Arki-Sofa	028	Gossip	116
Arki-Stool	030	Grace	116
Arod	031	Happy	117
Babila	033	Héra	118
Babila Comfort	047	Host	119
Babila Twist	048	Host lounge	121
Babila XL	049	HX	123
Blitz	053	HXL	124
Blume	054	Ice	125
Box	056	Ikon low stool	126
Brera	057	Ikon Bench	127
Buddy	063	Ila	130
Buddyhub	068	Inga	132
Buddy Sofa	072	Intrigo	137
Cube	074	Island	138
Cube XL	077	Jamaica	139
Day Dream	078	Jazz	140
Dome	079	Jeff	142
Dream	081	Jil	145
Dress	083	Joi	146
Elinor	085	Koi-Booki	147
Elle	086	Kuadra	149
Enjoy	086	Kuadra XL	165
Ester	087	Laja	182
Folk	092	Lamoris	186
Fox	095	Leila	186
		Log	188



## SEATING / SEDUTE

Lotus	189	Snow junior	285
Malmö	190	Social	286
Modus	199	Social Plus	290
Modus 2.0	215	Soul	293
Mood	223	Souvenir	294
Mya	223	Sunset	295
Nemea	226	Tatami	298
Noa	228	Temps	298
Nolita	231	Tivoli	299
Nolita Sofa	235	Tonda	302
Nym	236	Trend	303
Osaka	252	Tribeca	305
Osaka Metal	254	Trilly	307
Panarea	257	Tweet	307
Pasha	259	Twig	318
Permanent	262	TX	318
Plural	264	Vic	320 - 321
Plus	270	Vic Metal	321 - 322
Plus Air	270	Volt	325
Polar	272	Volt HB	329
Queen	274	Woody	330
Rail	277	Wow	331
Remind	275	Young	338
Reva	278	Zippo	342
Reva Cocoon	280		
Reva Twist	279		
Rubik	282	<b>Show-room displayers /</b>	
Serif	283	Espositori per show-room	356
Sign	284	<b>Fittings / Accessori</b>	344
Snow	285	<b>Finishes / Finiture</b>	362

# Condizioni generali di vendita e garanzia

## AMBITO DI APPLICAZIONE

Le presenti condizioni generali disciplinano tutti gli attuali e futuri rapporti tra Pedrali Spa ed il compratore, salvo eventuali deroghe specificatamente concordate per iscritto.

## PREZZI

I prezzi sono espressi in euro e sono Iva esclusa. Tutti i prezzi non comprendono dazi, tasse, imposte e spese di trasporto.

## VALIDITÀ PREZZI

Il presente listino prezzi ha validità dal 1 Gennaio 2023 sino a nuova comunicazione.

Qualunque offerta o proposta comunicata da agenti o da terzi e non formalizzata direttamente da Pedrali Spa, sarà valida solo quando verrà approvata per iscritto dall'azienda.

Le offerte emesse da Pedrali Spa hanno validità un mese dalla data di emissione, dopodiché l'azienda si riserva di rimettere una nuova offerta.

## ORDINE MINIMO

Importo minimo di ogni ordine 500,00 euro netti.

Qualsiasi ordine di importo inferiore a 500,00 euro netti non è da ritenersi accettato fino a conferma scritta da parte di Pedrali Spa.

## ACCETTAZIONE ORDINI

Si considerano validi solamente gli ordini ricevuti direttamente dal compratore.

Qualunque offerta o proposta comunicata da agenti o da terzi e non formalizzata direttamente da Pedrali Spa, è da ritenersi valida solo quando approvata per iscritto dall'azienda.

Per qualunque ordine di prodotti speciali non contemplati all'interno del presente listino deve essere fatta specifica richiesta. Pedrali Spa si riserva di valutarne la fattibilità, senza alcun impegno.

Gli ordini sono sempre subordinati all'accettazione di Pedrali Spa che si riserva la facoltà di rifiutarli entro 30 gg dalla ricezione.

In caso di richiesta della firma per accettazione da parte del compratore, l'ordine si considererà tale a partire dalla ricezione della conferma d'ordine firmata.

In caso di richiesta dell'acconto, l'ordine si considererà tale dalla ricezione dell'acconto.

## MODIFICHE DI ORDINE

Sono da considerarsi modifiche eventuali riduzioni di quantità o modifica di articolo.

Aggiunte di quantità si considerano nuovi ordini che decorreranno dalla ricezione del nuovo ordine.

L'azienda prende in considerazione solo modifiche di ordini effettuate entro 48 ore dalla ricezione degli stessi.

Previa valutazione, Pedrali Spa comunicherà se possibile accettare tali modifiche.

I tempi di consegna decorreranno dalla data della modifica.

Non si potrà accettare, in ogni caso, più di una modifica per ordine.

Eventuali modifiche di indirizzi di consegna successive all'invio della conferma d'ordine prevedono un addebito di costi amministrativi di 200,00 euro netti.

## ANNULLAMENTO ORDINE

È possibile annullare l'ordine entro 48 ore dalla ricezione della conferma d'ordine di Pedrali Spa. In seguito, l'annullamento non sarà più possibile.

Qualora il compratore dovesse, in ogni caso, per qualunque ragione dichiarare annullato l'ordine successivamente a tale fase, ovvero intendesse recedere dal contratto revocando l'ordine, eventuali acconti versati saranno trattenuti da Pedrali Spa a titolo di risarcimento danni, con diritto della stessa a richiedere al compratore ulteriori costi e spese sostenute per la produzione.

## **TEMPI DI CONSEGNA**

I tempi di consegna sono indicativi; il compratore non potrà pretendere né l'annullamento totale o parziale dell'ordine, né il rimborso di danni nel caso di ritardi di consegne.

In caso di richiesta della firma per accettazione del compratore sulla conferma d'ordine, o di richiesta di acconto, i tempi di consegna decorrono dalla data di ricezione degli stessi.

Per ordini ricevuti incompleti o contenenti prodotti in finiture, misure o varianti non appropriati, la data di consegna decorre dal momento in cui viene confermata la ricezione di informazioni complete e corrette.

Nel caso di imbottiti con tessuto cliente, i tempi di consegna decorrono dalla ricezione del tessuto e dalla conferma di fattibilità.

Nel caso di tinte a campione, i tempi di consegna decorrono dalla ricezione del campione.

## **MONTAGGIO E INSTALLAZIONE**

I prodotti possono essere consegnati smontati. Il montaggio e l'installazione sono a carico del compratore e devono essere eseguiti da montatori specializzati, seguendo le istruzioni di montaggio fornite da Pedrali Spa.

## **IMBALLO**

I nostri imballi sono adatti per trasporto a mezzo camion.

Eventuali imballi per trasporto via aerea devono essere specificati al momento dell'ordine. Il supplemento per l'imballo speciale è di 200,00 euro netto per ordine, cui si aggiungono 40,00 euro lordi a bancale.

La merce disposta su bancali non può essere sbancalata. I bancali non possono essere sovrapposti.

I cartoni sfusi devono essere movimentati sempre mantenendo il lato alto indicato sul cartone.

Per sedie/sgabelli con imballo standard multiplo è possibile richiedere imballo singolo, ove possibile, con un supplemento di 5,00 euro lordo a pezzo.

In caso di richiesta di pallet conforme alla normativa FAO ISPM 15, la richiesta deve essere avanzata al momento dell'ordine e prevede un supplemento di 40,00 euro lordi per ogni pallet.

## **PRODOTTI PER UTILIZZO ALL'ESTERNO**

Solo i prodotti contrassegnati dall'apposito simbolo, sono garantiti per utilizzo all'esterno.

Verande, piscine, centri termali, navi e location in prossimità dal mare, sono considerati ambienti esterni anche se non esposti direttamente a sole, pioggia e salsedine.

Si consiglia un rimessaggio protetto nel periodo di non utilizzo.

## **RESA DELLA MERCE**

La merce è venduta EX WORKS e viaggia a rischio e pericolo del committente.

Eventuali prezzi DAP/DDP devono essere concordati tra le parti e indicati espressamente nella conferma d'ordine.

In ogni caso nessuna responsabilità potrà essere imputata a Pedrali Spa, qualora si verificano casi di ammanco o avaria di varia natura causati durante lo stivaggio, il caricamento o il trasporto.

È nell'interesse del compratore verificare quantità e condizioni dell'imballo della merce prima del ritiro, facendo eventuali opportune riserve al corriere se necessario.

In caso di riserva, Pedrali Spa si renderà disponibile a chiedere il rimborso al corriere. In caso di assenza di riserva, Pedrali Spa declinerà ogni responsabilità. Eventuali danni devono essere comunicati entro e non oltre 8 giorni dalla ricezione della merce, e comunque prima che i prodotti vengano utilizzati.

L'indirizzo di destinazione dovrà essere quello del compratore. Nel caso il destinatario richieda la sponda idraulica, la richiesta dovrà essere avanzata al momento dell'ordine, con il costo di 130,00 euro netti.

Consegne ad un indirizzo diverso dal magazzino del compratore, devono essere concordate preventivamente tra le parti al momento dell'ordine. Devono altresì essere forniti un nominativo e un contatto telefonico del destinatario.

## **GARANZIA**

La garanzia si applica per un periodo di 24 mesi su vizi e difetti di produzione nelle normali condizioni d'uso previste per ogni singolo prodotto.

Tale garanzia decorre dalla data di fatturazione.

La garanzia opera e si applica soltanto a condizione che:

- i prodotti siano utilizzati nell'ambito dell'uso consentito
- i prodotti siano installati da tecnici qualificati secondo le istruzioni fornite da Pedrali Spa
- i prodotti non siano stati modificati o manomessi da terzi



- i prodotti non siano stati montati/abbinati a componenti non forniti da Pedrali Spa
- i prodotti imbottiti non siano stati rivestiti con tessuti forniti dal cliente. Non viene garantita la qualità della tappezzeria con materiali non forniti direttamente da Pedrali Spa
- i prodotti siano stati mantenuti o conservati correttamente come previsto dalle istruzioni di uso e manutenzione
- i prodotti siano stati interamente pagati

## **RECLAMI**

Ogni reclamo relativo a prodotti difettosi deve essere trasmesso per iscritto dall'acquirente direttamente a Pedrali Spa, entro 8 giorni dalla data della scoperta di vizio/difetto, pena di decadenza, con l'indicazione espressa del modello, della data di consegna, della descrizione del difetto e relative immagini, indicando anche la quantità dei prodotti difettosi.

Senza queste informazioni il reclamo non sarà considerato valido.

## **MODALITÀ DI ACCETTAZIONE DELLA GARANZIA**

Qualora Pedrali Spa riconoscesse il vizio/difetto, potrà scegliere di sostituire/riparare i prodotti difettosi o proporre un prodotto alternativo con le medesime caratteristiche essenziali.

Qualora la riparazione o la sostituzione si rivelasse impossibile o superasse il costo del valore dei prodotti difettosi, Pedrali Spa potrà recedere dal contratto accettando il reso della merce con trasporto a carico dell'acquirente e rimborsando il prezzo di acquisto (spese di trasporto, installazione escluse).

Pedrali Spa non accetta altri tipi di penali o rimborsi spese.

## **RESI**

Non si accettano resi di merce senza preventiva autorizzazione scritta da Pedrali Spa, la quale, in assenza di questa, si riserva il diritto di respingere la merce al mittente.

I resi di merce autorizzata devono essere inviati in porto franco, in perfetto stato e con imballo originale. In caso contrario Pedrali Spa si riserva il diritto di addebitare al compratore i costi sostenuti per la riparazione e la sostituzione dell'imballo.

La merce per la quale il reso è stato autorizzato sarà accreditata al costo di acquisto e gravata dal rimborso spese nella misura convenzionale del 20%.

## **PRODOTTI IGNIFUGHI**

Eventuali certificazioni di reazione a fuoco devono essere richieste al momento dell'ordine, non possono essere richieste successivamente alla conferma d'ordine.

## **MODIFICHE DI PRODOTTI**

Pedrali Spa si riserva il diritto di apportare in ogni momento, a suo insindacabile giudizio e senza necessità di preavviso, migliorie o modifiche ai propri prodotti.

Le descrizioni, illustrazioni, dati tecnici contenuti in cataloghi, listini, sito, ecc. di Pedrali Spa non hanno carattere vincolante.

## **PAGAMENTI**

I pagamenti devono essere indirizzati direttamente a Pedrali Spa, salvo diverse indicazioni sulla conferma d'ordine.

## **RISERVA DI PROPRIETÀ**

La proprietà dei prodotti rimarrà di Pedrali Spa fino a quando non verrà effettuato l'intero pagamento del relativo importo.

## **LEGGE APPLICABILE-CONTROVERSIE**

Per quanto non previsto nelle presenti condizioni si applica la legge italiana.

Per qualsiasi controversia è esclusivamente competente il Foro di Bergamo.

## **DISCLAIMER**

Pedrali Spa declina ogni responsabilità per danni a cose e persone causati da utilizzo improprio del prodotto, anche derivanti da una destinazione d'uso non preventivamente comunicataci e approvata da parte di Pedrali Spa.

# General terms and conditions of sale and warranty

## SCOPE OF APPLICATION

These present general conditions govern all current and future relationships between Pedrali Spa and the buyer, except for any exceptions specifically agreed upon in writing.

## PRICES

Prices are expressed in euro, VAT excluded. All prices do not include tariffs, taxes, fees and shipping costs.

## PRICE VALIDITY

This price list is valid from 1 January 2023 until further notice.

Any offer or proposal communicated by agents or third parties and not formalized directly by Pedrali Spa shall be valid only when it is approved in writing by the company. The offers issued by Pedrali Spa are valid for one month from the date of issue, after which the company reserves the right to issue a new offer.

## MINIMUM ORDER

The minimum amount of each order is 500,00 euro, net of VAT.

Any order of an amount less than 500,00 euro (net of VAT) shall not be considered accepted until written confirmation is provided by Pedrali Spa.

## ORDER ACCEPTANCE

Orders shall only be considered valid if they are received directly from the buyer.

Any offer or proposal communicated by agents or third parties and not formalized directly by Pedrali Spa shall be considered valid only when its approved in writing by the company.

Any order of special products not included in this price list must be the subject of a specific request. Pedrali Spa reserves the right to evaluate their feasibility, without any obligation.

Orders are always subject to acceptance by Pedrali Spa, that reserves the right to refuse them within 30 days of receipt.

In the event the buyer's signature is requested for acceptance, the order shall be considered concluded only upon receipt of the signed order confirmation.

In the event a down payment is requested, the order shall be considered concluded upon receipt of the payment.

## ORDER CHANGES

Any reductions in quantity or changes in articles are to be considered as changes to the order.

Added quantities shall be considered new orders, with times calculated from receipt of the new order.

The company shall only consider order changes made within 48 hours of receipt of the orders.

Subject to the evaluation of the request, Pedrali Spa shall communicate whether it is possible to accept the changes.

Delivery times shall be calculated from the date of the change.

In any event, no more than one change is permitted per order.

Any changes to the delivery address after the transmission of the order confirmation shall entail a charge of 200,00 euro (net of VAT) for administrative costs.

## ORDER CANCELLATION

Orders may be cancelled within 48 hours of receipt from the order confirmation by Pedrali Spa. Subsequently, cancellation will no longer be possible.

If the buyer, in any event and for any reason whatsoever, declare the cancellation of the order after such time, or intend to withdraw from the contract and revoke the order, any down payments shall be withheld by Pedrali Spa as compensation for damages. Pedrali Spa also reserves the right to request additional costs and expenses sustained for production from the buyer.

## **DELIVERY TIMES**

Delivery times are indicative; the buyer may not claim the total or partial cancellation of the order, nor reimbursement for damages in the case of delivery delays.

In the event the buyer's signature is requested on the order confirmation, or a down payment is requested, the delivery times shall be calculated from receipt of the same.

For orders that are incomplete when received or improperly indicate the finishings, measurements or versions of the products, the delivery date shall be calculated from the receipt of complete or correct information.

In the case of upholstery with the client's fabric, the delivery times shall be calculated from receipt of the fabric and confirmation of feasibility.

In the case of colors based on a sample, the delivery times shall be calculated from the receipt of the sample.

## **ASSEMBLY AND INSTALLATION**

The products may be delivered disassembled. Assembly and installation are the responsibility of the buyer and must be performed by specialized assemblers, following the assembly instructions provided by Pedrali Spa.

## **PACKAGING**

Our packaging materials are suitable for transport by truck.

Any packaging for air transport must be specified at the time of the order. The supplement for special packaging is 200,00 euro per order (net of VAT), to which 40,00 euro shall be added per pallet.

Goods arranged on pallets may not be depalletized. Pallets may not be stacked.

Loose boxes must always be handled with the correct side up.

For chairs/stools with multiple standard packaging, it is possible to request single packaging, where possible, with a supplement charge of gross 5,00 euro per item.

In the case of requests for pallets compliant with FAO ISPM 15 standards, the request shall be made at the time of the order, and entail a supplement charge of gross 40,00 euro per pallet.

## **PRODUCTS FOR EXTERNAL USE**

Only products marked with the specific symbol are guaranteed for external use.

Verandas, pools, spas, ships and locations near the sea are considered external environments even if they are not directly exposed to the sun, rain and sea salt.

Products must be stored in a protected area when not in use as recommended.

## **DELIVERY TRADE TERMS**

Goods are sold EX WORKS and shipping is at the risk and peril of the client.

Any DAP/DDP prices must be agreed upon by the parties and expressly indicated in the order confirmation.

In any event, no liability may be attributed to Pedrali Spa in the event of any shortages or problems of any kind caused during stowage, loading or shipping.

It is the buyer's responsibility to verify the quantity and conditions of the packaged goods before receipt, indicating any appropriate reservations to the courier where necessary.

In the event of reservations, Pedrali Spa shall request reimbursement from the courier. In the absence of any reservations, Pedrali Spa shall decline any liability.

Any damages must be notified by no later than 8 days of receipt of the goods and in any event before the products are used.

The delivery address must be that of the buyer.

In the event the recipient requests a tail lift, the request must be made at the time of the order, with a cost of 130,00 euro (net of VAT).

Deliveries to an address other than the buyer's warehouse must be agreed upon in advance between the parties at the time of the order. A name and telephone number of the recipient must also be provided.

## **WARRANTY**

The warranty applies for a period of 24 months on production flaws and defects in normal conditions of use for each single product.

The warranty applies from the invoice date.

The warranty shall apply subject to the following conditions:

- the products are used in the permitted area of use
- the products are installed by qualified technicians following the instructions provided by Pedrali Spa
- the products have not been modified or altered by third parties
- the products have not been assembled/combined with components not supplied by Pedrali Spa

- Upholstered products have not been covered with fabric supplied by the client. No warranty is provided for the quality of upholstering with materials not supplied directly by Pedrali Spa
- the products have been maintained or preserved properly as indicated by the instructions for use and maintenance
- the products have been paid for in full

## **COMPLAINTS**

Any complaints relating to defective products must be notified in writing by the buyer directly to Pedrali Spa within 8 days of the date the flaw/defect is discovered, on penalty of forfeiture, expressly indicating the model, delivery date, a description of the defect and the respective images, and also indicating the quantity of defective products.

Without such information, the complaint shall not be considered valid.

## **METHOD OF ACCEPTANCE OF WARRANTY**

If Pedrali Spa acknowledges the flaw/defect, it may choose to replace/repair the defective products or offer an alternative product with the same essential characteristics.

Should repair or replacement turn out to be impossible or exceed the value of the defective products, Pedrali Spa may withdraw from the contract accepting the return of the goods with shipping costs covered by the buyer and reimbursing the purchase price (shipping costs and installation excluded).

Pedrali Spa shall not accept any other types of liabilities or penalties or expense reimbursements.

## **RETURNS**

The return of goods shall not be accepted without written authorization from Pedrali Spa, which in the absence of such authorization, reserves the right to reject the goods from the sender.

Authorized returns of goods must be sent with carriage paid, in perfect condition and in the original packaging. In the absence of such conditions, Pedrali Spa reserves the right to charge the buyer for the costs sustained for the repair and replacement of the packaging.

The goods for which return has been authorized shall be credited at the purchase cost and subject to expense reimbursement at the conventional rate of 20%.

## **FIREPROOF PRODUCTS**

Any reaction-to-fire certifications must be requested at the time of the order, and cannot be requested after order confirmation.

## **PRODUCT ALTERATIONS**

Pedrali Spa reserves the right to make improvements or alterations to its products at any time, at its sole discretion and without the need to provide advance notice.

The descriptions, illustrations and technical data contained in the Pedrali Spa catalogues, price lists, website, etc. shall not be binding.

## **PAYMENTS**

Payments must be sent directly to Pedrali Spa, unless otherwise indicated on the order confirmation.

## **RETENTION OF TITLE**

Pedrali Spa remains the proprietor of the products until full payment is made of any respective amounts.

## **APPLICABLE LAW-DISPUTES**

Any matters not covered by these conditions shall be subject to the laws of Italy.

Any disputes shall be under the exclusive jurisdiction of the Courts of Bergamo.

## **DISCLAIMER**

Pedrali Spa accepts no responsibility for damages to things and people caused by an improper use of the product, also arising from an intended use, not previously notified to and approved by Pedrali Spa.

# Legend

## Legenda

<b>FS</b>	<b>Bleached beech</b> / Faggio sbiancato
<b>FR</b>	<b>Bleached ash</b> / Frassino sbiancato
<b>RS</b>	<b>Bleached oak</b> / Rovere sbiancato
<b>W</b>	<b>Oak stained wenge</b> / Rovere tinto wengé
<b>N1</b>	<b>Oak/ash stained light walnut</b> / Rovere/frassino tinto noce chiaro
<b>TC</b>	<b>Oak/ash stained on sample</b> / Rovere/frassino tinto campione
<b>EB</b>	<b>Ebony</b> / Ebanò
<b>ZB</b>	<b>Zebrano</b> / Zebrano
<b>N</b>	<b>Walnut</b> / Noce
<b>AN</b>	<b>Black lacquered oak/ash with visible grains, beech stained black</b> Rovere/frassino laccato nero a poro aperto, faggio tinto nero
<b>BI</b>	<b>White lacquered oak/ash with visible grains</b> / Rovere/frassino laccato bianco a poro aperto
<b>RA</b>	<b>Pink lacquered oak/ash with visible grains</b> / Rovere/frassino laccato rosa a poro aperto
<b>GC</b>	<b>Light grey lacquered oak/ash with visible grains</b> / Rovere/frassino laccato grigio chiaro a poro aperto
<b>BL2</b>	<b>Dark blue lacquered oak/ash with visible grains</b> / Rovere/frassino laccato blu scuro a poro aperto
<b>AZ1</b>	<b>Light blue lacquered oak/ash with visible grains</b> / Rovere/frassino laccato azzurro a poro aperto
<b>VE1</b>	<b>Light green lacquered oak/ash with visible grains</b> / Rovere/frassino laccato verde chiaro a poro aperto
<b>VE2</b>	<b>Dark green lacquered oak/ash with visible grains</b> / Rovere/frassino laccato verde scuro a poro aperto
<b>RB</b>	<b>Ruby red lacquered oak/ash with visible grains</b> / Rovere/frassino laccato rosso rubino a poro aperto
<b>MO</b>	<b>Mahogany lacquered oak/ash with visible grains</b> / Rovere/frassino laccato mogano a poro aperto
<b>MC</b>	<b>Cognac lacquered oak/ash with visible grains</b> / Rovere/frassino laccato cognac a poro aperto
<b>V101</b>	<b>Grey vintage</b> / Finitura grigio anticato
<b>V102</b>	<b>Wenge vintage</b> / Finitura wengé anticato
<b>V103</b>	<b>Walnut vintage</b> / Finitura noce anticato
<b>NCS</b>	<b>Laminate as per ABET NCS chart</b> / Laminato come da cartella colori ABET NCS
<b>NY</b>	<b>Nylon</b> / Nylon
<b>PET</b>	<b>Polyethylene</b> / Polietilene
<b>PPL</b>	<b>Polypropylene</b> / Polipropilene
<b>PC</b>	<b>Polycarbonate</b> / Policarbonato
<b>SCR</b>	<b>Chromed ABS</b> / ABS cromato
<b>TP</b>	<b>Tecnopolymer</b> / Tecnopolimero
<b>ME</b>	<b>Methacrylate</b> / Metacrilato
<b>A</b>	<b>Padded with cat. A</b> / Imbottitura con cat. A
<b>B</b>	<b>Padded with cat. B</b> / Imbottitura con cat. B
<b>C</b>	<b>Padded with cat. C</b> / Imbottitura con cat. C
<b>D</b>	<b>Padded with cat. D</b> / Imbottitura con cat. D
<b>E</b>	<b>Padded with cat. E</b> / Imbottitura con cat. E
<b>F</b>	<b>Padded with genuine or regenerated leather</b> / Rivestimento in cuoio naturale o rigenerato
<b>G</b>	<b>Padded with cat. G</b> / Imbottitura con cat. G
<b>H</b>	<b>Padded with cat. H</b> / Imbottitura con cat. H
<b>N</b>	<b>Padded with cat. N</b> / Imbottitura con cat. N
<b>P</b>	<b>Padded with cat. P</b> / Imbottitura con cat. P
<b>PF</b>	<b>Padded with cat. PF (perforated mid grain leather)</b> / Imbottitura con cat. PF (pelle mezzo fiore traforata)
<b>TC</b>	<b>Padded with customer own material</b> / Imbottitura con tessuto cliente
<b>CL</b>	<b>Padded with customer real leather</b> / Imbottitura con vera pelle cliente
<b>PG</b>	<b>Wooden panel and foam</b> / Pannello e gomma piuma
<b>TXT</b>	<b>Waterproof textile mesh</b> / Rete tessile impermeabile

# Legend

## Legenda

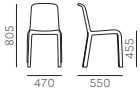

**All dimensions are in millimeters**  
Tutte le dimensioni sono espresse in millimetri



**Number of pieces per box and volume of carton in cubic meters**  
Numero di pezzi contenuti nell'imballo e volume in metri cubi del cartone

**KD**

**Disassembled product**  
Prodotto da assemblare



**Number of cartons per pallet**  
Numero di cartoni contenuti su pallet



**Stackable product**  
Prodotto impilabile



**Trolley for chairs/armchairs displacement**  
Carrello per movimentazione sedie/poltrone



**Weight of a single product in Kgs**  
Peso del singolo prodotto espresso in chilogrammi



**Product suitable for outdoor use**  
Prodotto adatto per utilizzo in esterni



**Product not recommended for outdoor use**  
Prodotto non adatto per utilizzo in esterni



**Product with swivel seat**  
Prodotto con seduta girevole



**Swivel seat with spring back device**  
Prodotto con seduta girevole e meccanismo di ritorno automatico



**FSC™ certified product**  
Prodotto certificato FSC™



PRODUCT CERTIFIED  
FOR LOW CHEMICAL  
EMISSIONS:  
UL COMF00  
UL 2818

**GREENGUARD certified product**  
Prodotto certificato GREENGUARD

# Outdoor seating / Sedute per esterno



ARA



BABILA  
Powder coated  
Verniciata



BABILA XL  
Powder coated  
Verniciata



BABILA TWIST



DOME



GOSSIP



HAPPY



GRACE  
410/ALE, 410/AC



ICE



INTRIGO



ENJOY



JOI



KUADRA  
1151/AC, 1115/AC



MYA  
Powder coated  
Verniciata



TRIBECA



NOLITA



NOLITA SOFA



PANAREA



PLUS



PLUS AIR  
BI, RO



DAY DREAM  
Powder coated  
Verniciata



KOI-BOOKI



ARKI-SOFA

**Outdoor seating** / Sedute per esterno



SOUL



LAMORISSE



REVA



REVA TWIST



REVA COCOON



RAIL



SUNSET



TATAMI



REMINDE



SOUVENIR



SERIF



VOLT



VOLT HB



SNOW



HOST lounge  
790/AC, 792/AC



PASHA  
BI, FU, TR



QUEEN  
BI, SA, FU, AM,  
TR, VL



RUBIK  
BI, SA, FU, RT, TR, VL



WOW

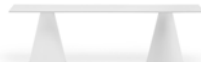

IKON-BENCH



ARKI-BENCH



## Plastic materials / Materie plastiche

Technopolymer and steel / Tecnopolimero e acciaio

---



KUADRA



KUADRA XL



GLISS lounge



GLISS swing



BABILA

Technopolymer and ash  
Tecnopolimero e frassino

---



GLISS wood



BABILA



GLISS



KUADRA



GLISS



GLISS lounge

Technopolymer and stainless steel  
Tecnopolimero e inox

---

Technopolymer and aluminium  
Tecnopolimero e alluminio

---

Polypropylene / Polipropilene

---



PLUS



SNOW



SNOW junior



ARA



ARA lounge



ENJOY



TATAMI



REMIND



VOLT



VOLT HB



DOME



HAPPY



GOSSIP



SOUVENIR

Polypropylene and ash / Polipropilene e frassino

---



BABILA



BABILA XL



FOX

Polypropylene and aluminium / Polipropilene e alluminio

---



KOI-BOOKI



MYA



JOI



ICE



TWEET



BABILA



PLURAL

# Plastic materials / Materie plastiche

## Polypropylene and steel / Polipropilene e acciaio

---



## Polypropylene and stainless steel Polipropilene e acciaio inox

---



## Polyethylene and stainless steel Polietilene e acciaio inox

---



## Polyethylene / Polietilene

---



## Polycarbonate / Policarbonato

---



## Polycarbonate and steel Policarbonato e acciaio

---



## Polycarbonate and aluminium Policarbonato e alluminio

---



## Polycarbonate and ash Policarbonato e frassino

---



## Chromed ABS and steel ABS cromato e acciaio

---



## Plastic materials / Materie plastiche

Thermoformed methacrylate  
Metacrilato termoformato

---



PASHA  
tray / vassoio

## Steel / Acciaio



NOLITA



PANAREA



BABILA TWIST



RAIL

## Aluminium / Alluminio



TRIBECA



INTRIGO



SOUL



LAMORISSE



REVA

## Plywood / Multistrato

Plywood and steel / Multistrato e acciaio

---



KUADRA



KUADRA XL



INGA



BABILA



WOODY



OSAKA metal

Plywood and stainless steel / Multistrato e acciaio inox

---



TX

Laminate and steel / Laminato e acciaio

---



KUADRA XL

# Wood / Legno

## Oak / Rovere



## Oak and steel / Rovere e acciaio



## Beech / Faggio



## Ash / Frassino



## Ash and aluminium / Frassino e alluminio



## Ash and steel / Frassino e acciaio



## Walnut / Noce





# Elenco prodotti in plastica con certificazione di reazione al fuoco

## CLASSE 1

### Polypropylene / Polipropilene



**SNOW**  
300 (BI)  
pag. 285

**KOI-BOOKI**  
370 (BI)  
pag. 147

**ARA**  
310, 315 (BI)  
pag. 24

**JOI**  
870 (BI, GA)  
pag. 146

**ICE**  
800, 850 (BI, GA)  
pag. 125

**VOLT**  
670, 675 (BI)  
pag. 325



**DOME**  
260, 265 (BI)  
pag. 79

**TWEET**  
890, 891/3, 892, 893, 893F, 894, 895, 896, 897, 898, 899 (any colour / tutti i colori)  
pag. 307

French certification M2 and German certification B1 are available as well  
Sono disponibili anche i certificati francese M2 e tedesco B1



**PLURAL**  
Any model  
Tutti i modelli  
pag. 264

### Polycarbonate / Policarbonato



**QUEEN**  
650 (TR)  
pag. 274

**BLITZ**  
640 (TR, BI)  
pag. 53

**GLISS**  
921 (TR)  
pag. 102

**DAY DREAM**  
401 (TR, BI)  
pag. 78









































































**PASHA**  
660, 661 (TR, BI)  
pag. 259

**RUBIK**  
580 (TR, BI)  
pag. 282



# Classificazione di reazione al fuoco ed omologazione ai fini della prevenzione incendi

## CLASSE 1.IM (UNO I EMME)

												
<b>ARKI-STOOL</b> Any model Tutti i modelli pag. 30	<b>BABILA</b> Any model Tutti i modelli pag. 33	<b>BABILA XL</b> Any model Tutti i modelli pag. 51	<b>BLUME</b> Any model Tutti i modelli pag. 54	<b>BUDDY</b> Any model Tutti i modelli pag. 63	<b>BUDDY Sofa</b> Any model Tutti i modelli pag. 72	<b>BUDDYHUB</b> Any model Tutti i modelli pag. 68						
												
<b>CUBE</b> Any model Tutti i modelli pag. 74	<b>DRESS</b> Any model Tutti i modelli pag. 83	<b>ELINOR</b> Any model Tutti i modelli pag. 85	<b>ESTER</b> Any model Tutti i modelli pag. 87	<b>FOLK</b> Any model Tutti i modelli pag. 92	<b>FOX</b> 3723, 3724 pag. 95	<b>GLAM</b> 430, 431, 435 pag. 98	<b>GLISS</b> 980, 1020, 1040 pag. 108					
												
<b>HÉRA</b> 2865, 2869 pag. 118	<b>HOST</b> Any model Tutti i modelli pag. 119	<b>HOST lounge</b> 791, 793 pag. 121	<b>IKON</b> 862 pag. 126	<b>ILA</b> Any model Tutti i modelli pag. 130	<b>INGA</b> 5683, 5684, 5685, 5686, 5689 pag. 133	<b>JAMAICA</b> 2911, 2916 pag. 139	<b>JAZZ</b> 3716, 3717, 3718, 3719 pag. 140	<b>JIL</b> 520, 525, 526 pag. 145				
												
<b>KUADRA</b> 1010, 1132 pag. 155	<b>KUADRA XL</b> 2441, 2442, 2443, 2444, 2481, 2482, 2483, 2484, 2491, 2492, 2493, 2494, 4429 pag. 170	<b>LAJA</b> Any model Tutti i modelli pag. 182	<b>LEILA</b> 681, 682, 683 pag. 186	<b>LOG</b> Any model Tutti i modelli pag. 188	<b>MALMÖ</b> 242, 246, 296, 298, 391, 396 pag. 191	<b>MODUS</b> Any model Tutti i modelli pag. 199	<b>MODUS 2.0</b> Any model Tutti i modelli pag. 215					
												
<b>NEMEA</b> Any model Tutti i modelli pag. 227	<b>NYM Soft</b> Any model Tutti i modelli pag. 238	<b>OSAKA Metal</b> 5721, 5722 pag. 254	<b>POLAR</b> Any model Tutti i modelli pag. 272	<b>SIGN</b> 455 pag. 284	<b>SOCIAL</b> Any model Tutti i modelli pag. 286	<b>SOCIAL Plus</b> Any model Tutti i modelli pag. 290	<b>TEMPS</b> Any model Tutti i modelli pag. 298					
												
<b>TIVOLI</b> Any model Tutti i modelli pag. 300	<b>TWEET</b> Any model Tutti i modelli pag. 311	<b>VIC</b> Any model Tutti i modelli pag. 320	<b>VIC Metal</b> Any model Tutti i modelli pag. 321	<b>VOLT</b> 671/2, 676/2, 677/2, 678/2 pag. 326	<b>VOLT HB</b> Any model Tutti i modelli pag. 329	<b>WOW</b> Any model Tutti i modelli pag. 331	<b>YOUNG</b> Any model Tutti i modelli pag. 340					

### CATEGORIE DI TESSUTO:

**SIMIL LEATHER / Finta pelle** cat. C60÷C64, C90÷C95, C130÷C141, H82÷H89, H20÷H35; H100÷H108

**WOOL / Lana** cat. G21 ÷G24, G110÷G116

**FABRIC / Tessuto** cat. C110÷C122, C210÷C217, D40÷D44, G59÷G78; G190÷G197, G100÷G102, G120÷G122, G130÷G133, G140÷G146, G150÷G156, G170÷G176; G210÷G213, G200÷G206, G160÷G169, H60, H120÷H127, N30÷N38

**VELVET / Velluto** cat. G180÷G185, H40÷H53, N20÷N27

Su richiesta possiamo fornire la dichiarazione di conformità per i prodotti citati.

E' necessario che tale richiesta sia specificata per iscritto al momento dell'ordine al fine di poter allegare la dichiarazione valida solo per la fornitura in oggetto.

## Pad printing / Stampa tampografica



### PLASTIC MATERIAL / MATERIALE PLASTICO

Polypropylene, polycarbonate, nylon, polyethylene  
Polipropilene, policarbonato, nylon, polietilene

Logo dimension to be confirmed after drawing receipt (maximum dimension from Ø160 up to Ø185 mm)

Maximum 3 colours each Logo

Minimum order: **50 pcs** of one single item

Surcharge: **€ 11,00** public each piece

Cliché and ink price: **€ 220,00** net each colour

The outdoor plastic chairs remain suitable for external use even with logo

Dimensione logo da confermare a seguito ricezione disegno (dimensione massima da Ø160 a Ø185 mm)

Massimo 3 colori per logo

Ordine minimo: **50 pz** di un singolo articolo

Supplemento: **€ 11,00** lordo ogni pezzo

Prezzo cliché e inchiostro **€ 220,00** netto per colore

Le sedute in plastica adatte per uso esterno rimangono tali anche con logo



### WOOD / LEGNO

Logo dimension to be confirmed after drawing receipt (maximum dimension from Ø160 up to Ø185 mm)

Maximum 3 colours each Logo

Minimum order: **50 pcs** of one single item

Surcharge: **€ 15,00** public each piece

Cliché and ink price: **€ 220,00** net each colour

Dimensione logo da confermare a seguito ricezione disegno (dimensione massima da Ø160 a Ø185 mm)

Massimo 3 colori per logo

Ordine minimo: **50 pz** di un singolo articolo

Supplemento: **€ 15,00** lordo ogni pezzo

Prezzo cliché e inchiostro **€ 220,00** netto per colore



### UPHOLSTERED / IMBOTTITO

Simil leather

Finta pelle

Logo dimension to be confirmed after drawing receipt (maximum dimension from Ø160 up to Ø185 mm)

Maximum 3 colours each Logo

Minimum order: **50 pcs** of one single item

Surcharge: **€ 11,00** public each piece

Cliché and ink price: **€ 220,00** net each colour

Dimensione logo da confermare a seguito ricezione disegno (dimensione massima da Ø160 a Ø185 mm)

Massimo 3 colori per logo

Ordine minimo: **50 pz** di un singolo articolo

Supplemento: **€ 11,00** lordo ogni pezzo

Prezzo cliché e inchiostro **€ 220,00** netto per colore





## Allure 735



SEAT Sedile	BACK Schienale	FRAME Telaio	OAK Rovere	OAK STAINED ON SAMPLE Rovere tinto campione
A	A		€ 409,00	€ 433,00
C*	C*		€ 425,00	€ 449,00
G	G	RS-W-N1- GC-BI	€ 506,00	€ 531,00
H*	H*		€ 438,00	€ 462,00
P*	P*	TC	€ 547,00	€ 571,00
TC**	TC**		€ 409,00	€ 433,00
CL**	CL**		€ 415,00	€ 439,00

\*\*TC/CL = Minimum order 10 pcs each fabric colour  
TC/CL = Ordine minimo 10 pz per colore/tessuto

\*Excluding / Escluso C36+C39, H140+H143, PBS-PCO-PMS-PVE

### FINISHES / Finiture



RS

W

N1

GC

BI

For fabrics see page 367  
Per i tessuti si veda a p. 367

### PACKING / Imballo



FABRIC REQUIRED / Fabbisogno tessuto  
1pc: Lin Mtrs 0,80 (h 1,40)

### TECHNICAL DETAILS / Dettagli tecnici

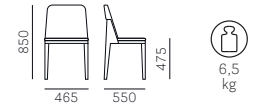

SAFETY, STRENGTH and DURABILITY TESTS  
Prove di sicurezza, resistenza e durata  
EN 1728:2012+AC2013  
EN 16139:2013 level 2

## Ara 310



SEAT Sedile	BACK Schienale	FRAME Telaio	POLYPROPYLENE Polipropilene
PPL	PPL	PPL	€ 65,00

### PPL FINISHES / Finiture PPL

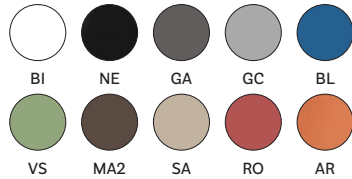

BI

NE

GA

GC

BL

VS

MA2

SA

RO

AR

### PACKING / Imballo



### TECHNICAL DETAILS / Dettagli tecnici

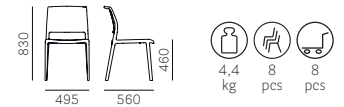

SAFETY, STRENGTH and DURABILITY TESTS  
Prove di sicurezza, resistenza e durata  
EN 1728:2000

## Ara 310/CL1

Fire retardant version  
Versione ignifuga



SEAT Sedile	BACK Schienale	FRAME Telaio	POLYPROPYLENE Polipropilene
PPL	PPL	PPL	€ 90,00

Minimum order 300 pcs  
Ordine minimo 300 pz

### PPL FINISHES / Finiture PPL



BI

### PACKING / Imballo



### TECHNICAL DETAILS / Dettagli tecnici

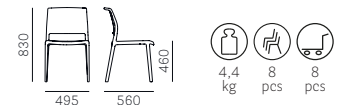

SAFETY, STRENGTH and DURABILITY TESTS  
Prove di sicurezza, resistenza e durata  
EN 1728:2000



## Ara 315



SEAT Sedile	BACK Schienale	FRAME Telaio	POLYPROPYLENE Polipropilene
PPL	PPL	PPL	€ 84,00

### PPL FINISHES / Finiture PPL

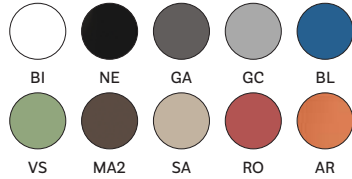

**SAFETY, STRENGTH and DURABILITY TESTS**  
Prove di sicurezza, resistenza e durata  
EN 1728:2000

### PACKING / Imballo



### TECHNICAL DETAILS / Dettagli tecnici

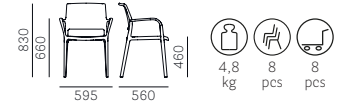

## Ara 315/CL1

Fire retardant version  
Versione ignifuga



SEAT Sedile	BACK Schienale	FRAME Telaio	POLYPROPYLENE Polipropilene
PPL	PPL	PPL	€ 112,00

Minimum order 300 pcs  
Ordine minimo 300 pz

### PPL FINISHES / Finiture PPL



**SAFETY, STRENGTH and DURABILITY TESTS**  
Prove di sicurezza, resistenza e durata  
EN 1728:2000

### PACKING / Imballo



### TECHNICAL DETAILS / Dettagli tecnici

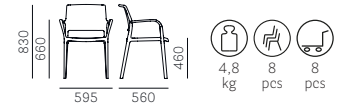

## Ara 316

LOUNGE



SEAT Sedile	BACK Schienale	FRAME Telaio	POLYPROPYLENE Polipropilene
PPL	PPL	PPL	€ 105,00

### PPL FINISHES / Finiture PPL



**SAFETY, STRENGTH and DURABILITY TESTS**  
Prove di sicurezza, resistenza e durata  
EN 1728:2012+AC2013  
EN 16139:2013 level 2

### PACKING / Imballo



### TECHNICAL DETAILS / Dettagli tecnici



## Arki-Bench ARKB



CODE Codice	TOP Ripiano	FRAME Telaio	BLACK POWDER COATED Verniciato nero	WHITE POWDER COATED Verniciato bianco
ARKB_119X36	119x36FNP_0720 NERO	NERO	€ 374,00	
	119x36CFP_BI BIANCO	BI100		€ 385,00
		BI100E		€ 440,00
ARKB_159X36	159x36FNP_0720 NERO	NERO	€ 435,00	
	159x36CFP_BI BIANCO	BI100		€ 451,00
		BI100E		€ 506,00
ARKB_199X36	199x36FNP_0720 NERO	NERO	€ 473,00	
	199x36CFP_BI BIANCO	BI100		€ 490,00
		BI100E		€ 545,00

## SAFETY, STRENGTH and DURABILITY TESTS

Prove di sicurezza, resistenza e durata

EN 1728:2012+AC2013

EN 16139:2013 level 2

## TOP FINISHES / Finiture ripiano

\*Anti-fingerprint finish  
Finitura anti-impronta

FNP\* CFP\_BI

## FRAME FINISHES / Finiture telaio

NERO BI100  
BI100E

## TECHNICAL DETAILS / Dettagli tecnici

## ARKB\_119X36

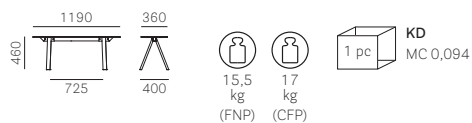

## ARKB\_159X36



## ARKB\_199X36

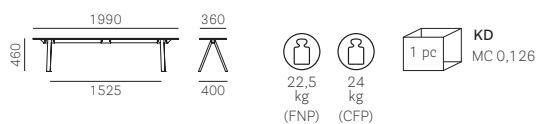

## Arki-Bench ARKBW



CODE Codice	TOP Ripiano	FRAME Telaio	OAK Rovere
<b>ARKBW_119X36</b>	119x36FNP_0720 NERO	RS	€ 523,00
	119x36CFP_BI BIANCO		€ 534,00
<b>ARKBW_159X36</b>	159x36FNP_0720 NERO	RS	€ 583,00
	159x36CFP_BI BIANCO		€ 600,00
<b>ARKBW_199X36</b>	199x36FNP_0720 NERO	RS	€ 622,00
	199x36CFP_BI BIANCO		€ 638,00

## TOP FINISHES / Finiture ripiano

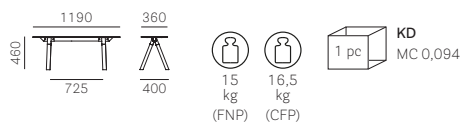

## FRAME FINISHES / Finiture telaio

TECHNICAL DETAILS / Dettagli tecnici  
ARKBW\_119X36

## ARKBW\_159X36

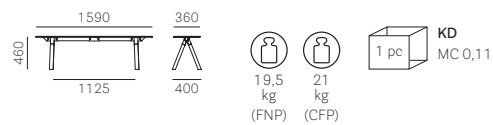

## ARKBW\_199X36

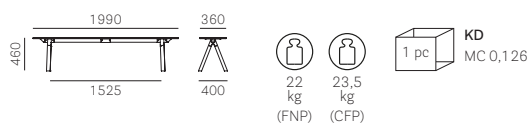



CODE Codice	SEAT Sedile	BACK Schienale	FRAME Telaio	POWDER COATED Verniciato
<b>AS0010</b> Armchair without armrests Poltrona senza braccioli	D22+D26 D80+D89 D100+D105 D110+D115 D130+D133	D22+D26 D80+D89 D100+D105 D110+D115 D130+D133	Powder coated / Verniciato	<b>€ 1.675,00</b>
<b>AS0111</b> Armchair with right or left armrest + back cushion Poltrona con bracciolo DX o SX + cuscino schienale	D22+D26 D80+D89 D100+D105 D110+D115 D130+D133	D22+D26 D80+D89 D100+D105 D110+D115 D130+D133	Powder coated / Verniciato	<b>€ 2.050,00</b>
<b>AS0012</b> Armchair Poltrona con braccioli	D22+D26 D80+D89 D100+D105 D110+D115 D130+D133	D22+D26 D80+D89 D100+D105 D110+D115 D130+D133	Powder coated / Verniciato	<b>€ 1.975,00</b>
<b>AS0020</b> Sofa without armrests Divano senza braccioli	D22+D26 D80+D89 D100+D105 D110+D115 D130+D133	D22+D26 D80+D89 D100+D105 D110+D115 D130+D133	Powder coated / Verniciato	<b>€ 3.105,00</b>
<b>AS0121</b> Sofa with right or left armrest + back cushion Divano con bracciolo DX o SX + cuscino schienale	D22+D26 D80+D89 D100+D105 D110+D115 D130+D133	D22+D26 D80+D89 D100+D105 D110+D115 D130+D133	Powder coated / Verniciato	<b>€ 3.480,00</b>
<b>AS0022</b> Sofa with armrests Divano con braccioli	D22+D26 D80+D89 D100+D105 D110+D115 D130+D133	D22+D26 D80+D89 D100+D105 D110+D115 D130+D133	Powder coated / Verniciato	<b>€ 3.405,00</b>
<b>AS0030</b> Chaise longue	D22+D26 D80+D89 D100+D105 D110+D115 D130+D133	D22+D26 D80+D89 D100+D105 D110+D115 D130+D133	Powder coated / Verniciato	<b>€ 1.975,00</b>
<b>AS0031</b> Chaise longue with right or left armrest Chaise longue con bracciolo DX o SX	D22+D26 D80+D89 D100+D105 D110+D115 D130+D133	D22+D26 D80+D89 D100+D105 D110+D115 D130+D133	Powder coated / Verniciato	<b>€ 2.125,00</b>
<b>AS0040</b> Pouf	D22+D26 D80+D89 D100+D105 D110+D115 D130+D133	D22+D26 D80+D89 D100+D105 D110+D115 D130+D133	Powder coated / Verniciato	<b>€ 1.185,00</b>
<b>AS_LINK</b>	Connecting plate kit for ARKI-SOFA sofas: surcharge € 35,00 Kit lamiera di collegamento per divani ARKI-SOFA: supplemento € 35,00			

Optional cushions available on request see page 344  
Disponibili a richiesta i cuscini accessori si veda a p. 344

Optional protective covers available on request see page 346  
Disponibili a richiesta le coperture protettive accessorie si veda a p. 346

## TECHNICAL DETAILS / Dettagli tecnici

### AS0010

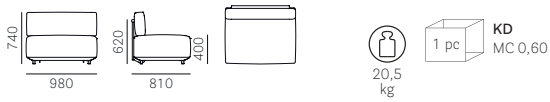

### AS0111\*

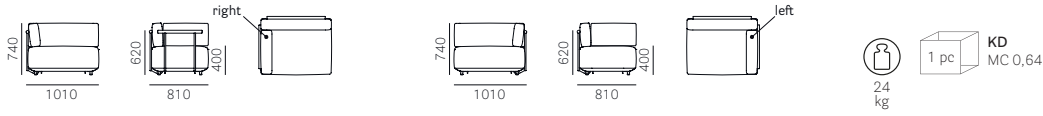

\* Only use this element for corner configurations  
Modulo da utilizzare esclusivamente per configurazioni angolari

### AS0012

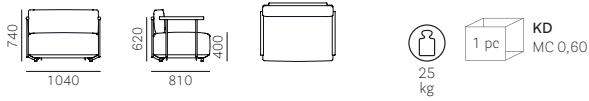

### AS0020

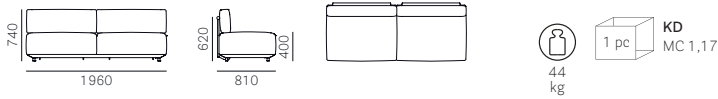

### AS0121\*

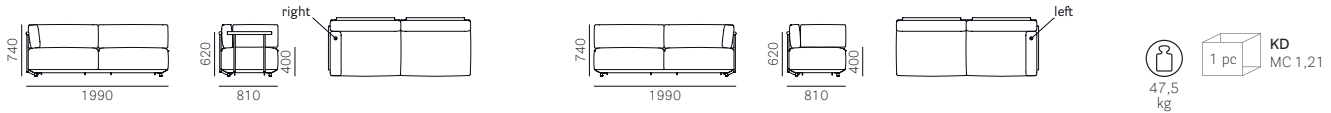

\* Only use this element for corner configurations  
Modulo da utilizzare esclusivamente per configurazioni angolari

### AS0022

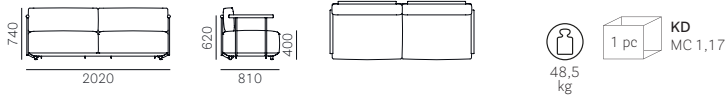

### AS0030

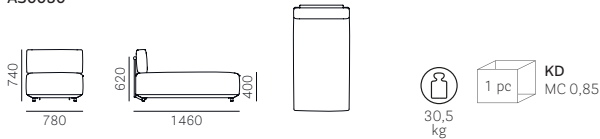

### AS0031

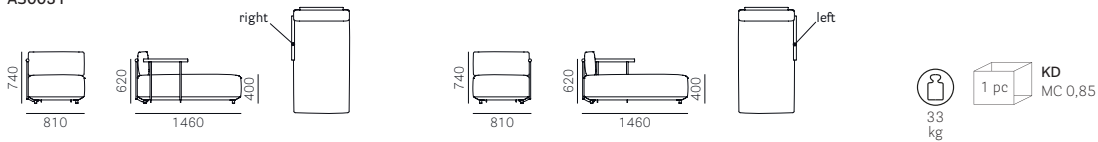

### AS0040

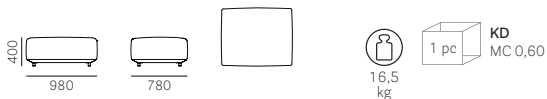

For fabrics see page 367  
Per i tessuti si veda a p. 367

For colours and finishes see at page 362  
Per colori e finiture vedere da pagina 362

## Arki-Stool ARKW6

Gas lift device  
Alzata a gas



SEAT Sedile	FRAME Telaio	WHITE POWDER COATED Verniciato bianco	BLACK POWDER COATED Verniciato nero	POWDER COATED Verniciato
RS-AN	650+750	€ 264,00 (RS)	€ 264,00 (AN)	€ 264,00 (RS-AN)

FINISHES / Finiture



POWDER COATED FINISHES / Finiture verniciato



SAFETY, STRENGTH and DURABILITY TESTS  
Prove di sicurezza, resistenza e durata  
EN 1728:2012+AC2013  
EN 16139:2013 level 2

PACKING / Imballo



TECHNICAL DETAILS / Dettagli tecnici



## Arki-Stool ARKW6/2

Gas lift device  
Alzata a gas



SEAT Sedile	FRAME Telaio	WHITE POWDER COATED Verniciato bianco	BLACK POWDER COATED Verniciato nero	POWDER COATED Verniciato
C36+C39 C83+C89; C100+C101 C110+C122 C210+C217	710+820	€ 341,00	€ 341,00	€ 341,00
D40+D44		€ 358,00	€ 358,00	€ 358,00
G*		€ 380,00	€ 380,00	€ 380,00
H60		€ 347,00	€ 347,00	€ 347,00
H120+H127 TC**		€ 325,00	€ 325,00	€ 325,00

\*\*TC = Minimum order 10 pcs each fabric colour  
TC = Ordine minimo 10 pz per colore/tessuto

\*Excluding / Escluso G180+G185, G230+G239

FINISHES / Finiture



POWDER COATED FINISHES / Finiture verniciato

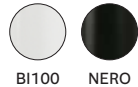

SAFETY, STRENGTH and DURABILITY TESTS  
Prove di sicurezza, resistenza e durata  
EN 1728:2012+AC2013  
EN 16139:2013 level 2

For fabrics see page 367  
Per i tessuti si veda a p. 367

PACKING / Imballo



FABRIC REQUIRED / Fabbisogno tessuto  
1pc: Lin Mtrs 0,48 (h 1,40)

TECHNICAL DETAILS / Dettagli tecnici

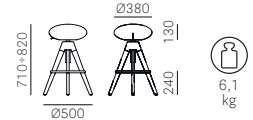

## Arki-Stool ARKW8

Gas lift device  
Alzata a gas



SEAT Sedile	FRAME Telaio	WHITE POWDER COATED Verniciato bianco	BLACK POWDER COATED Verniciato nero	POWDER COATED Verniciato
RS-AN	550+650	€ 264,00 (RS)	€ 264,00 (AN)	€ 264,00 (RS-AN)

FINISHES / Finiture



POWDER COATED FINISHES / Finiture verniciato



For colours and finishes see at page 362  
Per colori e finiture vedere da pagina 362

PACKING / Imballo



TECHNICAL DETAILS / Dettagli tecnici



## Arki-Stool ARKW8/2

Gas lift device  
Alzata a gas



SEAT Sedile	FRAME Telaio	WHITE POWDER COATED Verniciato bianco	BLACK POWDER COATED Verniciato nero	POWDER COATED Verniciato
C36+C39 C83+C89; C100+C101 C110+C122 C210+C217		<b>€ 341,00</b>	<b>€ 341,00</b>	<b>€ 341,00</b>
D40+D44	590*700	<b>€ 358,00</b>	<b>€ 358,00</b>	<b>€ 358,00</b>
G*		<b>€ 380,00</b>	<b>€ 380,00</b>	<b>€ 380,00</b>
H60		<b>€ 347,00</b>	<b>€ 347,00</b>	<b>€ 347,00</b>
H120+H127		<b>€ 325,00</b>	<b>€ 325,00</b>	<b>€ 325,00</b>
TC**				

\*\*TC = Minimum order 10 pcs each fabric colour  
TC = Ordine minimo 10 pz per colore/tessuto

\*Excluding / Escluso G180+G185, G230+G239

FINISHES / Finiture



POWDER COATED FINISHES / Finiture verniciato



For fabrics see page 367  
Per i tessuti si veda a p. 367

PACKING / Imballo



FABRIC REQUIRED / Fabbisogno tessuto  
1pc: Lin Mtrs 0,48 (h 1,40)

TECHNICAL DETAILS / Dettagli tecnici

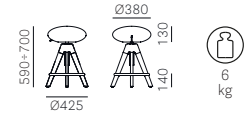

## Arod 500



SEAT Sedile	FRAME Telaio	CHROMED Cromato
PC	15x15 H650	<b>€ 194,00</b>
SCR		<b>€ 244,00</b>

PC FINISHES / Finiture PC

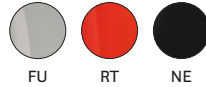

SCR FINISHES / Finiture SCR



PACKING / Imballo



TECHNICAL DETAILS / Dettagli tecnici

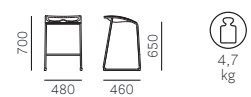

## Arod 500



SEAT Sedile	FRAME Telaio	BLACK POWDER COATED Verniciato nero
PC	15x15 H650	<b>€ 194,00</b>

PC FINISHES / Finiture PC



PACKING / Imballo



TECHNICAL DETAILS / Dettagli tecnici

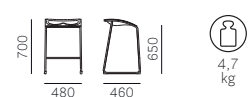

For colours and finishes see at page 362  
Per colori e finiture vedere da pagina 362



## Arod 510



SEAT Sedile	FRAME Telaio	CHROMED Cromato
PC	15x15 H760	€ 205,00
SCR		€ 255,00

PC FINISHES / Finiture PC

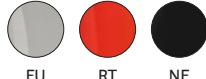

SCR FINISHES / Finiture SCR



SCR

PACKING / Imballo



TECHNICAL DETAILS / Dettagli tecnici

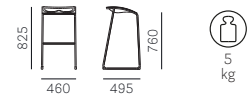

## Arod 510



SEAT Sedile	FRAME Telaio	BLACK POWDER COATED Verniciato nero
PC	15x15 H760	€ 205,00

PC FINISHES / Finiture PC



NE

PACKING / Imballo



TECHNICAL DETAILS / Dettagli tecnici

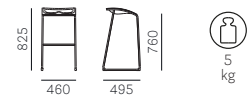

## Arod 560



SEAT Sedile	FRAME Telaio	CHROMED Cromato
PC	400x400 H770	€ 270,00
SCR		€ 319,00

PC FINISHES / Finiture PC

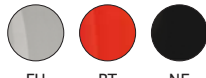

SCR FINISHES / Finiture SCR



SCR

PACKING / Imballo



TECHNICAL DETAILS / Dettagli tecnici

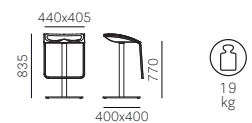

## Arod 570

Gas lift device  
Alzata a gas



SEAT Sedile	FRAME Telaio	CHROMED Cromato
PC	400x400 H540+800	€ 292,00
SCR		€ 341,00

PC FINISHES / Finiture PC

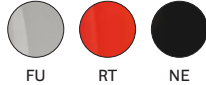

SCR FINISHES / Finiture SCR



SCR

PACKING / Imballo

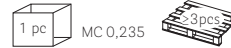

TECHNICAL DETAILS / Dettagli tecnici

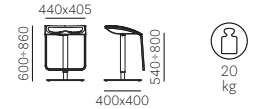

## Babila 2730



SEAT Sedile	BACK Schienale	FRAME Telaio	POWDER COATED Verniciato	CHROMED Cromato	OUTDOOR FINISHES Finiture per esterno
BI	BI	Ø 16	€ 85,00	€ 85,00	€ 98,00
SA-GR-NE- GI-RA2	SA-GR-NE- GI-RA2		€ 91,00	€ 91,00	€ 104,00

TP FINISHES / Finiture TP

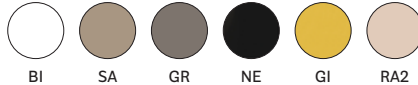

PACKING / Imballo



TECHNICAL DETAILS / Dettagli tecnici

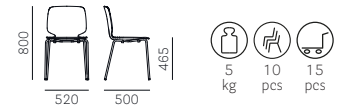

SAFETY, STRENGTH and DURABILITY TESTS  
Prove di sicurezza, resistenza e durata  
EN 1728:2012+AC2013  
EN 16139:2013 level 2

## Babila 2730/A



SEAT Sedile	BACK Schienale	FRAME Telaio	POWDER COATED Verniciato	CHROMED Cromato
A	BI	Ø 16	€ 128,00	€ 128,00
C *			€ 130,00	€ 130,00
D40÷D44			€ 137,00	€ 137,00
E			€ 146,00	€ 146,00
G			€ 146,00	€ 146,00
H *			€ 131,00	€ 131,00
P *			€ 152,00	€ 152,00
TC **			€ 128,00	€ 128,00

\*\*TC = Minimum order 10 pcs each fabric colour  
TC = Ordine minimo 10 pz per colore/tessuto

\*Excluding / Escluso C36+C39, H140+H143, PBS-PCO-PMS-PVE

TP FINISHES / Finiture TP



BI

For fabrics see page 367  
Per i tessuti si veda a p. 367

PACKING / Imballo



TECHNICAL DETAILS / Dettagli tecnici



SAFETY, STRENGTH and DURABILITY TESTS  
Prove di sicurezza, resistenza e durata  
EN 1728:2012+AC2013  
EN 16139:2013 level 2

FABRIC REQUIRED / Fabbisogno tessuto  
1 pc: Lin Mtrs 0,60 (h 1,40)

For colours and finishes see at page 362  
Per colori e finiture vedere da pagina 362

## Babila 2740



SEAT Sedile	BACK Schienale	FRAME Telaio	POWDER COATED Verniciato	CHROMED Cromato
BI	BI	Ø 10	€ 91,00	€ 91,00
SA-GR-NE- GI-RA2	SA-GR-NE- GI-RA2		€ 98,00	€ 98,00

TP FINISHES / Finiture TP



PACKING / Imballo



TECHNICAL DETAILS / Dettagli tecnici

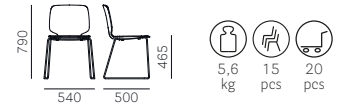

## Babila 2740/A



SEAT Sedile	BACK Schienale	FRAME Telaio	POWDER COATED Verniciato	CHROMED Cromato
A			€ 134,00	€ 134,00
C*			€ 136,00	€ 136,00
D40÷D44			€ 143,00	€ 143,00
E			€ 152,00	€ 152,00
G	BI	Ø 10	€ 152,00	€ 152,00
H*			€ 138,00	€ 138,00
P*			€ 158,00	€ 158,00
TC**			€ 134,00	€ 134,00

\*\*TC = Minimum order 10 pcs each fabric colour  
TC = Ordine minimo 10 pz per colore/tessuto

\*Excluding / Escluso C36+C39, H140+H143, PBS-PCO-PMS-PVE

For fabrics see page 367  
Per i tessuti si veda a p. 367

TP FINISHES / Finiture TP



PACKING / Imballo



TECHNICAL DETAILS / Dettagli tecnici

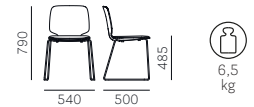

FABRIC REQUIRED / Fabbisogno tessuto  
1pc: Lin Mtrs 0,60 (h 1,40)

## Babila 2750



SEAT Sedile	BACK Schienale	FRAME Telaio	ASH Frassino	ASH STAINED ON SAMPLE Frassino tinto campione
BI	BI	FR-N1-AN	€ 139,00	€ 165,00
SA-GR-NE- GI-RA2	SA-GR-NE- GI-RA2	TC	€ 146,00	€ 171,00

Minimum order q.ty: 20 pcs  
Ordine minimo: 20pz

TP FINISHES / Finiture TP

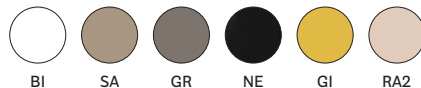

PACKING / Imballo



TECHNICAL DETAILS / Dettagli tecnici



SAFETY, STRENGTH and DURABILITY TESTS  
Prove di sicurezza, resistenza e durata  
EN 1728:2012+AC2013  
EN 16139:2013 level 2

WOODEN FINISHES / Finiture legno



For colours and finishes see at page 362  
Per colori e finiture vedere da pagina 362



## Babila 2750/A



SEAT Sedile	BACK Schienale	FRAME Telaio	ASH Frassino	ASH STAINED ON SAMPLE Frassino tinto campione
A			€ 182,00	€ 208,00
C*			€ 184,00	€ 210,00
D40+D44			€ 191,00	€ 217,00
E	BI	FR-N1-AN	€ 201,00	€ 226,00
G		TC	€ 201,00	€ 226,00
H*			€ 185,00	€ 211,00
P*			€ 206,00	€ 232,00
TC**			€ 182,00	€ 208,00

\*\*TC = Minimum order 10 pcs each fabric colour  
TC = Ordine minimo 10 pz per colore/tessuto  
\*Excluding / Escluso C36+C39, H140+H143, PBS-PCO-PMS-PVE

TP FINISHES / Finiture TP



BI

WOODEN FINISHES / Finiture legno



FR

N1

AN

SAFETY, STRENGTH and DURABILITY TESTS  
Prove di sicurezza, resistenza e durata  
EN 1728:2012+AC2013  
EN 16139:2013 level 2

For fabrics see page 367  
Per i tessuti si veda a p. 367

PACKING / Imballo



FABRIC REQUIRED / Fabbisogno tessuto  
1pc: Lin Mtrs 0,60 (h 1,40)

TECHNICAL DETAILS / Dettagli tecnici



## Babila 2700



SEAT Sedile	BACK Schienale	FRAME Telaio	ASH Frassino	ASH STAINED ON SAMPLE Frassino tinto campione
FR-N1-GC- BI-AN	FR-N1-GC- BI-AN	FR-N1-GC- BI-AN	€ 219,00	
TC	TC	TC		€ 241,00

FINISHES / Finiture

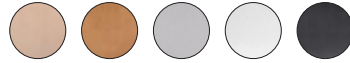

FR

N1

GC

BI

AN

SAFETY, STRENGTH and DURABILITY TESTS  
Prove di sicurezza, resistenza e durata  
EN 1728:2012+AC2013  
EN 16139:2013 level 2

PACKING / Imballo



TECHNICAL DETAILS / Dettagli tecnici



PRODUCT CERTIFIED  
FOR LOW CHEMICAL  
EMISSIONS:  
UL.COM/GG  
UL 2818

## Babila 2700



SEAT Sedile	BACK Schienale	FRAME Telaio	ASH Frassino
BL2	BL2	BL2	€ 230,00 Lacquered with visible grains Laccato a poro aperto
AZ1	AZ1	AZ1	
VE2	VE2	VE2	
VE1	VE1	VE1	
RB	RB	RB	
RA	RA	RA	
MO	MO	MO	
MC	MC	MC	

FINISHES / Finiture



BL2

AZ1

VE2

VE1

RB

RA

MO

MC

SAFETY, STRENGTH and DURABILITY TESTS  
Prove di sicurezza, resistenza e durata  
EN 1728:2012+AC2013  
EN 16139:2013 level 2

PACKING / Imballo



TECHNICAL DETAILS / Dettagli tecnici



PRODUCT CERTIFIED  
FOR LOW CHEMICAL  
EMISSIONS:  
UL.COM/GG  
UL 2818

## Babila 2700/A



SEAT Sedile	BACK Schienale	FRAME Telaio	ASH Frassino	ASH STAINED ON SAMPLE Frassino tinto campione
A			€ 260,00	€ 282,00
C*			€ 262,00	€ 284,00
D40+D44			€ 269,00	€ 291,00
E	FR-N1-GC- BI-AN	FR-N1-GC- BI-AN	€ 278,00	€ 300,00
G			€ 278,00	€ 300,00
H*	TC	TC	€ 263,00	€ 285,00
P*			€ 283,00	€ 305,00
TC**			€ 260,00	€ 282,00

\*\*TC = Minimum order 10 pcs each fabric colour  
TC = Ordine minimo 10 pz per colore/tessuto

\*Excluding / Escluso C36+C39, H140+H143, PBS-PCO-PMS-PVE

### FINISHES / Finiture

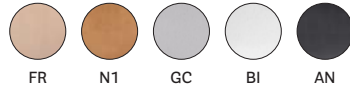

For fabrics see page 367  
Per i tessuti si veda a p. 367

### PACKING / Imballo



FABRIC REQUIRED / Fabbisogno tessuto  
1pc: Lin Mtrs 0,60 (h 1,40)

### TECHNICAL DETAILS / Dettagli tecnici



SAFETY, STRENGTH and DURABILITY TESTS  
Prove di sicurezza, resistenza e durata  
EN 1728:2012+AC2013  
EN 16139:2013 level 2



## Babila 2710



SEAT Sedile	BACK Schienale	FRAME Telaio	ASH Frassino			ASH STAINED ON SAMPLE Frassino tinto campione		
			POWDER COATED Verniciato	CHROMED Cromato	ANTIQUE BRASS Ottone anticato	POWDER COATED Verniciato	CHROMED Cromato	ANTIQUE BRASS Ottone anticato
FR-N1-GC- MC-AN	FR-N1-GC- MC-AN	Ø 16	€ 175,00	€ 175,00	€ 247,00			
TC	TC					€ 186,00	€ 186,00	€ 258,00

### FINISHES / Finiture



### PACKING / Imballo



### TECHNICAL DETAILS / Dettagli tecnici



SAFETY, STRENGTH and DURABILITY TESTS  
Prove di sicurezza, resistenza e durata  
EN 1728:2012+AC2013  
EN 16139:2013 level 2



## Babila 2710/A



SEAT Sedile	BACK Schienale	FRAME Telaio	ASH Frassino			ASH STAINED ON SAMPLE Frassino tinto campione		
			POWDER COATED Verniciato	CHROMED Cromato	ANTIQUE BRASS Ottone anticato	POWDER COATED Verniciato	CHROMED Cromato	ANTIQUE BRASS Ottone anticato
A		Ø 16	€ 220,00	€ 220,00	€ 293,00	€ 230,00	€ 230,00	€ 303,00
C*			€ 222,00	€ 222,00	€ 295,00	€ 233,00	€ 233,00	€ 306,00
D40+D44			€ 229,00	€ 229,00	€ 302,00	€ 240,00	€ 240,00	€ 313,00
E	FR-N1-GC- MC-AN		€ 239,00	€ 239,00	€ 312,00	€ 250,00	€ 250,00	€ 323,00
G			€ 239,00	€ 239,00	€ 312,00	€ 250,00	€ 250,00	€ 323,00
H*	TC		€ 223,00	€ 223,00	€ 296,00	€ 234,00	€ 234,00	€ 307,00
P*			€ 245,00	€ 245,00	€ 318,00	€ 256,00	€ 256,00	€ 329,00
TC**			€ 220,00	€ 220,00	€ 293,00	€ 230,00	€ 230,00	€ 303,00

\*\*TC = Minimum order 10 pcs each fabric colour  
TC = Ordine minimo 10 pz per colore/tessuto

\*Excluding / Escluso C36+C39, H140+H143, PBS-PCO-PMS-PVE

### FINISHES / Finiture

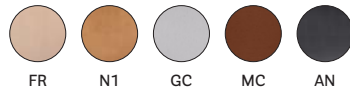

For fabrics see page 367  
Per i tessuti si veda a p. 367

### PACKING / Imballo



FABRIC REQUIRED / Fabbisogno tessuto  
1pc: Lin Mtrs 0,60 (h 1,40)

### TECHNICAL DETAILS / Dettagli tecnici



For colours and finishes see at page 362  
Per colori e finiture vedere da pagina 362



## Babila 2720



SEAT Sedile	BACK Schienale	FRAME Telaio	ASH Frassino			ASH STAINED ON SAMPLE Frassino tinto campione		
			POWDER COATED Verniciato	CHROMED Cromato	ANTIQU BRASS Ottone anticato	POWDER COATED Verniciato	CHROMED Cromato	ANTIQU BRASS Ottone anticato
FR-N1-GC- MC-AN	FR-N1-GC- MC-AN	Ø 10	€ 169,00	€ 169,00	€ 241,00	€ 180,00	€ 180,00	€ 252,00
TC	TC							

FINISHES / Finiture

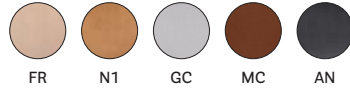

PACKING / Imballo



TECHNICAL DETAILS / Dettagli tecnici

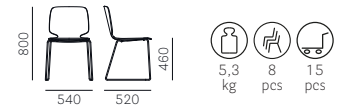

SAFETY, STRENGTH and DURABILITY TESTS  
Prove di sicurezza, resistenza e durata  
EN 1728:2012+AC2013  
EN 16139:2013 level 2



## Babila 2720/A



SEAT Sedile	BACK Schienale	FRAME Telaio	ASH Frassino			ASH STAINED ON SAMPLE Frassino tinto campione		
			POWDER COATED Verniciato	CHROMED Cromato	ANTIQU BRASS Ottone anticato	POWDER COATED Verniciato	CHROMED Cromato	ANTIQU BRASS Ottone anticato
A	FR-N1-GC- MC-AN	Ø 10	€ 214,00	€ 214,00	€ 286,00	€ 224,00	€ 224,00	€ 297,00
C*			€ 216,00	€ 216,00	€ 289,00	€ 227,00	€ 227,00	€ 300,00
D40÷D44			€ 223,00	€ 223,00	€ 296,00	€ 234,00	€ 234,00	€ 307,00
E			€ 233,00	€ 233,00	€ 306,00	€ 244,00	€ 244,00	€ 317,00
G			€ 233,00	€ 233,00	€ 306,00	€ 244,00	€ 244,00	€ 317,00
H*	TC	Ø 10	€ 217,00	€ 217,00	€ 290,00	€ 228,00	€ 228,00	€ 301,00
P*			€ 239,00	€ 239,00	€ 312,00	€ 250,00	€ 250,00	€ 323,00
TC**			€ 214,00	€ 214,00	€ 286,00	€ 224,00	€ 224,00	€ 297,00

\*\*TC = Minimum order 10 pcs each fabric colour  
TC = Ordine minimo 10 pz per colore/tessuto

\*Excluding / Escluso C36+C39, H140+H143, PBS-PCO-PMS-PVE

FINISHES / Finiture



PACKING / Imballo



FABRIC REQUIRED / Fabbisogno tessuto

1pc: Lin Mtrs 0,60 (h 1,40)

TECHNICAL DETAILS / Dettagli tecnici



SAFETY, STRENGTH and DURABILITY TESTS  
Prove di sicurezza, resistenza e durata  
EN 1728:2012+AC2013  
EN 16139:2013 level 2

For fabrics see page 367  
Per i tessuti si veda a p. 367

## Babila 2731

SOFT



SEAT Sedile	BACK Schienale	FRAME Telaio	POWDER COATED Verniciato	CHROMED Cromato	ANTIQU BRASS Ottone anticato
C*	C*	Ø 16	€ 225,00	€ 225,00	€ 294,00
D40÷D44	D40÷D44		€ 252,00	€ 252,00	€ 321,00
E	E		€ 294,00	€ 294,00	€ 363,00
G	G		€ 294,00	€ 294,00	€ 363,00
H*	H*		€ 234,00	€ 234,00	€ 303,00
TC**	TC**		€ 202,00	€ 202,00	€ 271,00

\*\*TC = Minimum order 10 pcs each fabric colour. Feasibility to be approved  
TC = Ordine minimo 10 pz per colore/tessuto. Fattibilità da valutare

\*Excluding / Escluso C36+C39, C60+C64, H140+H143

For fabrics see page 367  
Per i tessuti si veda a p. 367

PACKING / Imballo



FABRIC REQUIRED / Fabbisogno tessuto

1pc: Lin Mtrs 0,80 (h 1,40)

TECHNICAL DETAILS / Dettagli tecnici



SAFETY, STRENGTH and DURABILITY TESTS  
Prove di sicurezza, resistenza e durata  
EN 1728:2012+AC2013  
EN 16139:2013 level 2

For colours and finishes see at page 362  
Per colori e finiture vedere da pagina 362

## Babila 2741

SOFT



SEAT Sedile	BACK Schienale	FRAME Telaio	POWDER COATED Verniciato	CHROMED Cromato	ANTIQU BRASS Ottone anticato
C*	C*		€ 230,00	€ 230,00	€ 300,00
D40÷D44	D40÷D44		€ 258,00	€ 258,00	€ 327,00
E	E	Ø 10	€ 300,00	€ 300,00	€ 369,00
G	G		€ 300,00	€ 300,00	€ 369,00
H*	H*		€ 240,00	€ 240,00	€ 309,00
TC**	TC**		€ 207,00	€ 207,00	€ 277,00

\*\*TC = Minimum order 10 pcs each fabric colour. Feasibility to be approved  
TC = Ordine minimo 10 pz per colore/tessuto. Fattibilità da valutare

\*Excluding / Escluso C36÷C39, C60÷C64, H140+H143

For fabrics see page 367  
Per i tessuti si veda a p. 367

PACKING / Imballo



FABRIC REQUIRED / Fabbisogno tessuto  
1pc: Lin Mtrs 0,80 (h 1,40)

TECHNICAL DETAILS / Dettagli tecnici

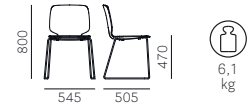

## Babila 2751

SOFT



SEAT Sedile	BACK Schienale	FRAME Telaio	ASH Frassino	ASH STAINED ON SAMPLE Frassino tinto campione
C*	C*		€ 275,00	€ 298,00
D40÷D44	D40÷D44		€ 302,00	€ 325,00
E	E	FR-N1-GC- BI-AN	€ 344,00	€ 367,00
G	G	TC	€ 344,00	€ 367,00
H*	H*		€ 283,00	€ 307,00
TC**	TC**		€ 251,00	€ 275,00

\*\*TC = Minimum order 10 pcs each fabric colour. Feasibility to be approved  
TC = Ordine minimo 10 pz per colore/tessuto. Fattibilità da valutare

\*Excluding / Escluso C36÷C39, C60÷C64, H140+H143

For fabrics see page 367  
Per i tessuti si veda a p. 367

PACKING / Imballo



FABRIC REQUIRED / Fabbisogno tessuto  
1pc: Lin Mtrs 0,80 (h 1,40)

TECHNICAL DETAILS / Dettagli tecnici



FINISHES / Finiture

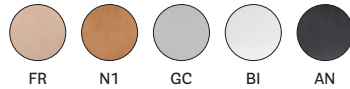

## Babila 2735



SEAT Sedile	BACK Schienale	FRAME Telaio	POWDER COATED Verniciato	CHROMED Cromato	OUTDOOR FINISHES Finiture per esterno
PPL	PPL	Ø 16	€ 93,00	€ 93,00	€ 105,00

PPL FINISHES / Finiture PPL



PACKING / Imballo



TECHNICAL DETAILS / Dettagli tecnici



SAFETY, STRENGTH and DURABILITY TESTS  
Prove di sicurezza, resistenza e durata  
EN 1728:2012+AC2013  
EN 16139:2013 level 2

For colours and finishes see at page 362  
Per colori e finiture vedere da pagina 362



## Babila 2745



SEAT Sedile	BACK Schienale	FRAME Telaio	POWDER COATED Verniciato	CHROMED Cromato
PPL	PPL	Ø 11	€ 99,00	€ 99,00

PPL FINISHES / Finiture PPL



PACKING / Imballo



TECHNICAL DETAILS / Dettagli tecnici

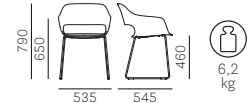

SAFETY, STRENGTH and DURABILITY TESTS  
Prove di sicurezza, resistenza e durata  
EN 1728:2012+AC2013  
EN 16139:2013 level 2



## Babila 2755



SEAT Sedile	BACK Schienale	FRAME Telaio	ASH Frassino	ASH STAINED ON SAMPLE Frassino tinto campione
PPL	PPL	FR-N1-AN  TC	€ 145,00	€ 169,00

PPL FINISHES / Finiture PPL



PACKING / Imballo



TECHNICAL DETAILS / Dettagli tecnici



SAFETY, STRENGTH and DURABILITY TESTS  
Prove di sicurezza, resistenza e durata  
EN 1728:2012+AC2013  
EN 16139:2013 level 2

WOODEN FINISHES / Finiture legno



## Babila 2765



SEAT Sedile	BACK Schienale	FRAME Telaio	BRUSHED S/STEEL Inox satinato	POLISHED S/STEEL Inox lucidato
PPL	PPL	Ø 450	€ 218,00	€ 230,00

PPL FINISHES / Finiture PPL



PACKING / Imballo



TECHNICAL DETAILS / Dettagli tecnici

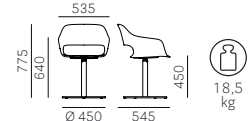

For colours and finishes see at page 362  
Per colori e finiture vedere da pagina 362





## Babila 2775



SEAT Sedile	BACK Schienale	FRAME Telaio	WHITE/BLACK POWDER COATED Verniciato bianco/nero	POLISHED S/STEEL Inox lucidato
PPL	PPL	Ø 680	€ 182,00	€ 218,00

PPL FINISHES / Finiture PPL



PACKING / Imballo



TECHNICAL DETAILS / Dettagli tecnici

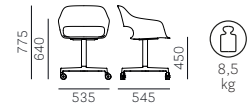

## Babila 2736

SOFT



SEAT Sedile	BACK Schienale	FRAME Telaio	POWDER COATED Verniciato	CHROMED Cromato	ANTIQU BRASS Ottone anticato
C*	C*		€ 362,00	€ 362,00	€ 445,00
D40÷D44	D40÷D44		€ 412,00	€ 412,00	€ 494,00
E	E	Ø 16	€ 510,00	€ 510,00	€ 592,00
G	G		€ 488,00	€ 488,00	€ 570,00
H*	H*		€ 380,00	€ 380,00	€ 462,00
TC**	TC**		€ 321,00	€ 321,00	€ 403,00

\*\*TC = Minimum order 10 pcs each fabric colour. Feasibility to be approved  
TC = Ordine minimo 10 pz per colore/tessuto. Fattibilità da valutare

\*Excluding / Escluso C36+C39, C60+C64, H140+H143

For fabrics see page 367  
Per i tessuti si veda a p. 367

PACKING / Imballo



FABRIC REQUIRED / Fabbisogno tessuto  
1 pc: Lin Mtrs 1,40 (h 1,40)

TECHNICAL DETAILS / Dettagli tecnici



SAFETY, STRENGTH and DURABILITY TESTS  
Prove di sicurezza, resistenza e durata  
EN 1728:2012+AC2013  
EN 16139:2013 level 2

## Babila 2746

SOFT



SEAT Sedile	BACK Schienale	FRAME Telaio	POWDER COATED Verniciato	CHROMED Cromato	ANTIQU BRASS Ottone anticato
C*	C*		€ 368,00	€ 368,00	€ 450,00
D40÷D44	D40÷D44		€ 417,00	€ 417,00	€ 500,00
E	E	Ø 11	€ 515,00	€ 515,00	€ 598,00
G	G		€ 493,00	€ 493,00	€ 576,00
H*	H*		€ 385,00	€ 385,00	€ 468,00
TC**	TC**		€ 326,00	€ 326,00	€ 409,00

\*\*TC = Minimum order 10 pcs each fabric colour. Feasibility to be approved  
TC = Ordine minimo 10 pz per colore/tessuto. Fattibilità da valutare

\*Excluding / Escluso C36+C39, C60+C64, H140+H143

For fabrics see page 367  
Per i tessuti si veda a p. 367

PACKING / Imballo



FABRIC REQUIRED / Fabbisogno tessuto  
1 pc: Lin Mtrs 1,40 (h 1,40)

TECHNICAL DETAILS / Dettagli tecnici



SAFETY, STRENGTH and DURABILITY TESTS  
Prove di sicurezza, resistenza e durata  
EN 1728:2012+AC2013  
EN 16139:2013 level 2

For colours and finishes see at page 362  
Per colori e finiture vedere da pagina 362

## Babila 2756

SOFT



SEAT Sedile	BACK Schienale	FRAME Telaio	ASH Frassino	ASH STAINED ON SAMPLE Frassino tinto campione
C*	C*		€ 410,00	€ 432,00
D40÷D44	D40÷D44		€ 459,00	€ 481,00
E	E	FR-N1-GC- BI-AN	€ 557,00	€ 579,00
G	G	TC	€ 535,00	€ 557,00
H*	H*		€ 427,00	€ 449,00
TC**	TC**		€ 368,00	€ 390,00

\*\*TC = Minimum order 10 pcs each fabric colour. Feasibility to be approved  
TC = Ordine minimo 10 pz per colore/tessuto. Fattibilità da valutare

\*Excluding / Escluso C36÷C39, C60÷C64, H140+H143

For fabrics see page 367  
Per i tessuti si veda a p. 367

FINISHES / Finiture



PACKING / Imballo



FABRIC REQUIRED / Fabbisogno tessuto  
1pc: Lin Mtrs 1,40 (h 1,40)

TECHNICAL DETAILS / Dettagli tecnici



SAFETY, STRENGTH and DURABILITY TESTS  
Prove di sicurezza, resistenza e durata  
EN 1728:2012+AC2013  
EN 16139:2013 level 2



## Babila 2766

SOFT



SEAT Sedile	BACK Schienale	FRAME Telaio	BRUSHED S/STEEL Inox satinato	POLISHED S/STEEL Inox lucidato
C*	C*		€ 477,00	€ 488,00
D40÷D44	D40÷D44		€ 526,00	€ 537,00
E	E	Ø 450	€ 624,00	€ 635,00
G	G		€ 602,00	€ 613,00
H*	H*		€ 494,00	€ 505,00
TC**	TC**		€ 435,00	€ 446,00

\*\*TC = Minimum order 10 pcs each fabric colour. Feasibility to be approved  
TC = Ordine minimo 10 pz per colore/tessuto. Fattibilità da valutare

\*Excluding / Escluso C36÷C39, C60÷C64, H140+H143

For fabrics see page 367  
Per i tessuti si veda a p. 367

PACKING / Imballo



FABRIC REQUIRED / Fabbisogno tessuto  
1pc: Lin Mtrs 1,40 (h 1,40)

TECHNICAL DETAILS / Dettagli tecnici

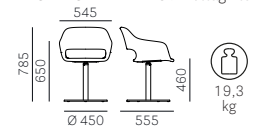

## Babila 2776

SOFT



SEAT Sedile	BACK Schienale	FRAME Telaio	WHITE/BLACK POWDER COATED Verniciato bianco/nero	POLISHED S/STEEL Inox lucidato
C*	C*		€ 444,00	€ 477,00
D40÷D44	D40÷D44		€ 493,00	€ 526,00
E	E	Ø 680	€ 591,00	€ 624,00
G	G		€ 569,00	€ 602,00
H*	H*		€ 461,00	€ 494,00
TC**	TC**		€ 402,00	€ 435,00

\*\*TC = Minimum order 10 pcs each fabric colour. Feasibility to be approved  
TC = Ordine minimo 10 pz per colore/tessuto. Fattibilità da valutare

\*Excluding / Escluso C36÷C39, C60÷C64, H140+H143

For fabrics see page 367  
Per i tessuti si veda a p. 367

PACKING / Imballo



FABRIC REQUIRED / Fabbisogno tessuto  
1pc: Lin Mtrs 1,40 (h 1,40)

TECHNICAL DETAILS / Dettagli tecnici



## Babila 2703



SEAT Sedile	FRAME Telaio	ASH Frassino	ASH STAINED ON SAMPLE Frassino tinto campione
FR-N1-GC-BI-AN	H460	€ 171,00	
TC			€ 193,00

### FINISHES / Finiture



### PACKING / Imballo



### TECHNICAL DETAILS / Dettagli tecnici



## Babila 2703



SEAT Sedile	FRAME Telaio	ASH Frassino
BL2 AZ1 VE2 VE1 RB RA MO MC	H460	€ 182,00 Lacquered with visible grains Laccato a poro aperto

### FINISHES / Finiture



### PACKING / Imballo



### TECHNICAL DETAILS / Dettagli tecnici



## Babila 2703/A



SEAT Sedile	FRAME Telaio	ASH Frassino	ASH STAINED ON SAMPLE Frassino tinto campione
A	H490	€ 220,00	€ 234,00
C*		€ 226,00	€ 239,00
D40÷D44		€ 233,00	€ 246,00
E		€ 241,00	€ 255,00
G		€ 241,00	€ 255,00
H*		€ 227,00	€ 240,00
P*		€ 249,00	€ 262,00
TC**		€ 220,00	€ 234,00

\*\*TC = Minimum order 10 pcs each fabric colour  
TC = Ordine minimo 10 pz per colore/tessuto

\*Excluding / Escluso C36+C39, H140+H143, PBS-PCO-PMS-PVE

For fabrics see page 367  
Per i tessuti si veda a p. 367

### FINISHES / Finiture



### PACKING / Imballo



**FABRIC REQUIRED / Fabbisogno tessuto**  
1 pc: Lin Mtrs 0,48 (h 1,40)

### TECHNICAL DETAILS / Dettagli tecnici



## Babila 2702



SEAT Sedile	FRAME Telaio	ASH Frassino				ASH STAINED ON SAMPLE Frassino tinto campione
		POWDER COATED Verniciato	POLISHED ALUMINIUM Alluminio lucidato	SATINIZED Satinato	ANTIQUÉ BRASS Ottone anticato	POWDER COATED Verniciato
FR-N1-GC-BI-AN	H650	€ 173,00	€ 206,00	€ 206,00	€ 228,00	€ 195,00
TC *						

\*Die-casted aluminium footrest, black powder coated  
Poggiapiedi in pressofusione di alluminio verniciato nero

FINISHES / Finiture



PACKING / Imballo



TECHNICAL DETAILS / Dettagli tecnici



SAFETY, STRENGTH and DURABILITY TESTS  
Prove di sicurezza, resistenza e durata  
EN 1728:2012+AC2013  
EN 16139:2013 level 2



## Babila 2702



SEAT Sedile	FRAME Telaio	ASH Frassino				
		WHITE POWDER COATED Verniciato bianco	BLACK POWDER COATED Verniciato nero	POLISHED ALUMINIUM Alluminio lucidato	SATINIZED Satinato	ANTIQUÉ BRASS Ottone anticato
BL2 AZ1* VE2 VE1* RB RA* MO MC	H650	€ 184,00*	€ 184,00	€ 217,00	€ 217,00	€ 239,00

\*Die-casted aluminium footrest, white powder coated  
Poggiapiedi in pressofusione di alluminio verniciato bianco

FINISHES / Finiture



PACKING / Imballo



TECHNICAL DETAILS / Dettagli tecnici



SAFETY, STRENGTH and DURABILITY TESTS  
Prove di sicurezza, resistenza e durata  
EN 1728:2012+AC2013  
EN 16139:2013 level 2



## Babila 2702/A



SEAT Sedile	FRAME Telaio	ASH Frassino				ASH STAINED ON SAMPLE Frassino tinto campione
		POWDER COATED Verniciato	POLISHED ALUMINIUM Alluminio lucidato	SATINIZED Satinato	ANTIQUÉ BRASS Ottone anticato	POWDER COATED Verniciato
A	H680	€ 223,00	€ 256,00	€ 256,00	€ 278,00	€ 245,00*
C **		€ 228,00	€ 261,00	€ 261,00	€ 283,00	€ 250,00*
D40÷D44		€ 235,00	€ 268,00	€ 268,00	€ 290,00	€ 257,00*
E		€ 244,00	€ 277,00	€ 277,00	€ 299,00	€ 266,00*
G		€ 244,00	€ 277,00	€ 277,00	€ 299,00	€ 266,00*
H **		€ 229,00	€ 262,00	€ 262,00	€ 284,00	€ 251,00*
P **		€ 251,00	€ 284,00	€ 284,00	€ 306,00	€ 273,00*
TC ***		€ 223,00	€ 256,00	€ 256,00	€ 278,00	€ 245,00*

\*\*\*TC = Minimum order 10 pcs each fabric colour

TC = Ordine minimo 10 pz per colore/tessuto

\*\*Excluding / Escluso C36+C39, H140+H143, PBS-PCO-PMS-PVE

\*Die-casted aluminium footrest, black powder coated  
Poggiapiedi in pressofusione di alluminio verniciato nero

For fabrics see page 367  
Per i tessuti si veda a p. 367

FINISHES / Finiture



PACKING / Imballo



TECHNICAL DETAILS / Dettagli tecnici



SAFETY, STRENGTH and DURABILITY TESTS  
Prove di sicurezza, resistenza e durata  
EN 1728:2012+AC2013  
EN 16139:2013 level 2

FABRIC REQUIRED / Fabbisogno tessuto

1 pc: Lin Mtrs 0,48 (h 1,40)

For colours and finishes see at page 362  
Per colori e finiture vedere da pagina 362



## Babila 2706



SEAT Sedile	FRAME Telaio	ASH Frassino				ASH STAINED ON SAMPLE Frassino tinto campione
		POWDER COATED Verniciato	POLISHED ALUMINIUM Alluminio lucidato	SATINIZED Satinato	ANTIQUÉ BRASS Ottone anticato	POWDER COATED Verniciato
FR-N1-GC-BI-AN	H750	€ 173,00	€ 206,00	€ 206,00	€ 228,00	€ 195,00
TC *						

\*Die-casted aluminium footrest, black powder coated  
Poggiapiedi in pressofusione di alluminio verniciato nero

FINISHES / Finiture

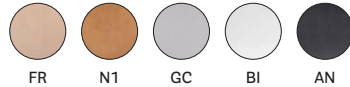

PACKING / Imballo



TECHNICAL DETAILS / Dettagli tecnici



SAFETY, STRENGTH and DURABILITY TESTS  
Prove di sicurezza, resistenza e durata  
EN 1728:2012+AC2013  
EN 16139:2013 level 2



## Babila 2706



SEAT Sedile	FRAME Telaio	ASH Frassino				
		WHITE POWDER COATED Verniciato bianco	BLACK POWDER COATED Verniciato nero	POLISHED ALUMINIUM Alluminio lucidato	SATINIZED Satinato	ANTIQUÉ BRASS Ottone anticato
BL2 AZ1* VE2 VE1* RB RA* MO MC	H750	€ 184,00*	€ 184,00	€ 217,00	€ 217,00	€ 239,00

\*Die-casted aluminium footrest, white powder coated  
Poggiapiedi in pressofusione di alluminio verniciato bianco

FINISHES / Finiture



PACKING / Imballo



TECHNICAL DETAILS / Dettagli tecnici



SAFETY, STRENGTH and DURABILITY TESTS  
Prove di sicurezza, resistenza e durata  
EN 1728:2012+AC2013  
EN 16139:2013 level 2



## Babila 2706/A



SEAT Sedile	FRAME Telaio	ASH Frassino				ASH STAINED ON SAMPLE Frassino tinto campione
		POWDER COATED Verniciato	POLISHED ALUMINIUM Alluminio lucidato	SATINIZED Satinato	ANTIQUÉ BRASS Ottone anticato	POWDER COATED Verniciato
A	H780	€ 223,00	€ 256,00	€ 256,00	€ 278,00	€ 245,00*
C **		€ 228,00	€ 261,00	€ 261,00	€ 283,00	€ 250,00*
D40÷D44		€ 235,00	€ 268,00	€ 268,00	€ 290,00	€ 257,00*
E		€ 244,00	€ 277,00	€ 277,00	€ 299,00	€ 266,00*
G		€ 244,00	€ 277,00	€ 277,00	€ 299,00	€ 266,00*
H **		€ 229,00	€ 262,00	€ 262,00	€ 284,00	€ 251,00*
P **		€ 251,00	€ 284,00	€ 284,00	€ 306,00	€ 273,00*
TC ***		€ 223,00	€ 256,00	€ 256,00	€ 278,00	€ 245,00*

\*\*\*TC = Minimum order 10 pcs each fabric colour  
TC = Ordine minimo 10 pz per colore/tessuto

\*\*Excluding / Escluso C36+C39, H140+H143, PBS-PCO-PMS-PVE

\*Die-casted aluminium footrest, black powder coated  
Poggiapiedi in pressofusione di alluminio verniciato nero

For fabrics see page 367  
Per i tessuti si veda a p. 367

PACKING / Imballo



TECHNICAL DETAILS / Dettagli tecnici



SAFETY, STRENGTH and DURABILITY TESTS  
Prove di sicurezza, resistenza e durata  
EN 1728:2012+AC2013  
EN 16139:2013 level 2

FINISHES / Finiture



FABRIC REQUIRED / Fabbisogno tessuto

1 pc: Lin Mtrs 0,48 (h 1,40)

For colours and finishes see at page 362  
Per colori e finiture vedere da pagina 362



## Babila 2747



SEAT Sedile	BACK Schienale	FRAME Telaio	POWDER COATED Verniciato	CHROMED Cromato	ANTIQU BRASS Ottone anticato
PPL	PPL	H645	€ 113,00	€ 120,00	€ 197,00

PPL FINISHES / Finiture PPL



PACKING / Imballo



TECHNICAL DETAILS / Dettagli tecnici

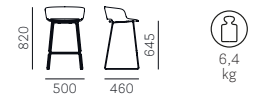

SAFETY, STRENGTH and DURABILITY TESTS  
Prove di sicurezza, resistenza e durata  
EN 1728:2012+AC2013  
EN 16139:2013 level 2



## Babila 2748



SEAT Sedile	BACK Schienale	FRAME Telaio	POWDER COATED Verniciato	CHROMED Cromato	ANTIQU BRASS Ottone anticato
PPL	PPL	H745	€ 115,00	€ 123,00	€ 204,00

PPL FINISHES / Finiture PPL



PACKING / Imballo



TECHNICAL DETAILS / Dettagli tecnici

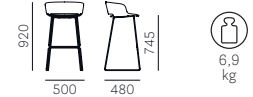

SAFETY, STRENGTH and DURABILITY TESTS  
Prove di sicurezza, resistenza e durata  
EN 1728:2012+AC2013  
EN 16139:2013 level 2



## Babila 2757



SEAT Sedile	BACK Schienale	FRAME Telaio	ASH Frassino			ASH STAINED ON SAMPLE Frassino tinto campione	
			POWDER COATED Verniciato	POLISHED ALUMINIUM Alluminio lucidato	SATINIZED Satinato	ANTIQU BRASS Ottone anticato	BLACK POWDER COATED Verniciato nero
PPL	PPL	H645	€ 229,00	€ 279,00	€ 279,00	€ 301,00	€ 251,00

PPL FINISHES / Finiture PPL



PACKING / Imballo



TECHNICAL DETAILS / Dettagli tecnici



SAFETY, STRENGTH and DURABILITY TESTS  
Prove di sicurezza, resistenza e durata  
EN 1728:2012+AC2013  
EN 16139:2013 level 2

WOODEN FINISHES / Finiture legno



For colours and finishes see at page 362  
Per colori e finiture vedere da pagina 362



## Babila 2758



SEAT Sedile	BACK Schienale	FRAME Telaio	ASH Frassino				ASH STAINED ON SAMPLE Frassino tinto campione
			POWDER COATED Verniciato	POLISHED ALUMINIUM Alluminio lucidato	SATINIZED Satinato	ANTIQU BRASS Ottone anticato	BLACK POWDER COATED Verniciato nero
PPL	PPL	H745	€ 229,00	€ 279,00	€ 279,00	€ 301,00	€ 251,00

Minimum order q.ty: 20 pcs  
Ordine minimo: 20pz

## PPL FINISHES / Finiture PPL



## WOODEN FINISHES / Finiture legno



## PACKING / Imballo



## TECHNICAL DETAILS / Dettagli tecnici



SAFETY, STRENGTH and DURABILITY TESTS  
Prove di sicurezza, resistenza e durata  
EN 1728:2012+AC2013  
EN 16139:2013 level 2

## Babila 2747/2



SEAT Sedile	BACK Schienale	FRAME Telaio	POWDER COATED Verniciato	CHROMED Cromato	ANTIQU BRASS Ottone anticato
C*	C*	H655	€ 343,00	€ 350,00	€ 427,00
D40÷D44	D40÷D44		€ 376,00	€ 383,00	€ 460,00
E	E		€ 448,00	€ 456,00	€ 533,00
G	G		€ 426,00	€ 434,00	€ 511,00
H*	H*		€ 354,00	€ 361,00	€ 438,00
TC**	TC**		€ 314,00	€ 322,00	€ 399,00

\*\*TC = Minimum order 10 pcs each fabric colour. Feasibility to be approved  
TC = Ordine minimo 10 pz per colore/tessuto. Fattibilità da valutare

\*Excluding / Escluso C36+C39, C60+C64, H140+H143

For fabrics see page 367  
Per i tessuti si veda a p. 367

## PACKING / Imballo



## TECHNICAL DETAILS / Dettagli tecnici

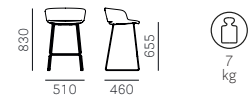

SAFETY, STRENGTH and DURABILITY TESTS  
Prove di sicurezza, resistenza e durata  
EN 1728:2012+AC2013  
EN 16139:2013 level 2

## Babila 2748/2



SEAT Sedile	BACK Schienale	FRAME Telaio	POWDER COATED Verniciato	CHROMED Cromato	ANTIQU BRASS Ottone anticato
C*	C*	H755	€ 345,00	€ 352,00	€ 434,00
D40÷D44	D40÷D44		€ 378,00	€ 385,00	€ 467,00
E	E		€ 450,00	€ 458,00	€ 539,00
G	G		€ 428,00	€ 436,00	€ 517,00
H*	H*		€ 356,00	€ 363,00	€ 445,00
TC**	TC**		€ 316,00	€ 324,00	€ 405,00

\*\*TC = Minimum order 10 pcs each fabric colour. Feasibility to be approved  
TC = Ordine minimo 10 pz per colore/tessuto. Fattibilità da valutare

\*Excluding / Escluso C36+C39, C60+C64, H140+H143

For fabrics see page 367  
Per i tessuti si veda a p. 367

## PACKING / Imballo



## TECHNICAL DETAILS / Dettagli tecnici

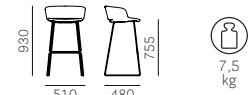

SAFETY, STRENGTH and DURABILITY TESTS  
Prove di sicurezza, resistenza e durata  
EN 1728:2012+AC2013  
EN 16139:2013 level 2

For colours and finishes see at page 362  
Per colori e finiture vedere da pagina 362

## Babila 2757/2



SEAT Sedile	BACK Schienale	FRAME Telaio	ASH Frassino				ASH STAINED ON SAMPLE Frassino tinto campione
			POWDER COATED Verniciato	POLISHED ALUMINIUM Alluminio lucidato	SATINIZED Satinato	ANTIQUÉ BRASS Ottone anticato	BLACK POWDER COATED Verniciato nero
C*	C*	H655	€ 459,00	€ 509,00	€ 509,00	€ 531,00	€ 481,00
D40÷D44	D40÷D44		€ 492,00	€ 542,00	€ 542,00	€ 564,00	€ 514,00
E	E		€ 565,00	€ 614,00	€ 614,00	€ 636,00	€ 587,00
G	G		€ 543,00	€ 592,00	€ 592,00	€ 614,00	€ 565,00
H*	H*		€ 470,00	€ 520,00	€ 520,00	€ 542,00	€ 492,00
TC**	TC**		€ 431,00	€ 480,00	€ 480,00	€ 502,00	€ 453,00

\*\*TC = Minimum order 10 pcs each fabric colour. Feasibility to be approved  
TC = Ordine minimo 10 pz per colore/tessuto. Fattibilità da valutare

\*Excluding / Escluso C36+C39, C60+C64, H140+H143

For fabrics see page 367  
Per i tessuti si veda a p. 367

PACKING / Imballo

TECHNICAL DETAILS / Dettagli tecnici

FINISHES / Finiture



FABRIC REQUIRED / Fabbisogno tessuto  
1pc: Lin Mtrs 1,00 (h 1,40)



SAFETY, STRENGTH and DURABILITY TESTS  
Prove di sicurezza, resistenza e durata  
EN 1728:2012+AC2013  
EN 16139:2013 level 2



## Babila 2758/2



SEAT Sedile	BACK Schienale	FRAME Telaio	ASH Frassino				ASH STAINED ON SAMPLE Frassino tinto campione
			POWDER COATED Verniciato	POLISHED ALUMINIUM Alluminio lucidato	SATINIZED Satinato	ANTIQUÉ BRASS Ottone anticato	BLACK POWDER COATED Verniciato nero
C*	C*	H755	€ 459,00	€ 509,00	€ 509,00	€ 531,00	€ 481,00
D40÷D44	D40÷D44		€ 492,00	€ 542,00	€ 542,00	€ 564,00	€ 514,00
E	E		€ 565,00	€ 614,00	€ 614,00	€ 636,00	€ 587,00
G	G		€ 543,00	€ 592,00	€ 592,00	€ 614,00	€ 565,00
H*	H*		€ 470,00	€ 520,00	€ 520,00	€ 542,00	€ 492,00
TC**	TC**		€ 431,00	€ 480,00	€ 480,00	€ 502,00	€ 453,00

\*\*TC = Minimum order 10 pcs each fabric colour. Feasibility to be approved  
TC = Ordine minimo 10 pz per colore/tessuto. Fattibilità da valutare

\*Excluding / Escluso C36+C39, C60+C64, H140+H143

For fabrics see page 367  
Per i tessuti si veda a p. 367

PACKING / Imballo

TECHNICAL DETAILS / Dettagli tecnici

FINISHES / Finiture



FABRIC REQUIRED / Fabbisogno tessuto  
1pc: Lin Mtrs 1,00 (h 1,40)



SAFETY, STRENGTH and DURABILITY TESTS  
Prove di sicurezza, resistenza e durata  
EN 1728:2012+AC2013  
EN 16139:2013 level 2



## Babila Comfort 2749



SEAT Sedile	BACK Schienale	FRAME Telaio	POWDER COATED Verniciato	CHROMED Cromato	ANTIQUÉ BRASS Ottone anticato	TITANIUM Titanio
C*	C*	Ø 12	€ 805,00	€ 805,00	€ 897,00	€ 897,00
D40÷D44 D120÷D123	D40÷D44 D120÷D123		€ 874,00	€ 874,00	€ 966,00	€ 966,00
E	E		€ 1.067,00	€ 1.067,00	€ 1.159,00	€ 1.159,00
G	G		€ 980,00	€ 980,00	€ 1.073,00	€ 1.073,00
H*	H*		€ 829,00	€ 829,00	€ 921,00	€ 921,00
TC**	TC**		€ 745,00	€ 745,00	€ 838,00	€ 838,00

\*\*TC = Minimum order 10 pcs each fabric colour. Feasibility to be approved  
TC = Ordine minimo 10 pz per colore/tessuto. Fattibilità da valutare

\*Excluding / Escluso C36+C39, C60+C64, C90+C95, H120+H127

For fabrics see page 367  
Per i tessuti si veda a p. 367

PACKING / Imballo

TECHNICAL DETAILS / Dettagli tecnici

FINISHES / Finiture



FABRIC REQUIRED / Fabbisogno tessuto  
1pc: Lin Mtrs 2,00 (h 1,40)

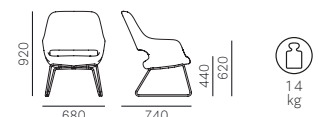

For colours and finishes see at page 362  
Per colori e finiture vedere da pagina 362



## Babila Comfort 2759



SEAT Sedile	BACK Schienale	FRAME Telaio	ASH Frassino	ASH STAINED ON SAMPLE Frassino tinto campione
C*	C*		€ 880,00	€ 903,00
D40÷D44 D120÷D123	D40÷D44 D120÷D123	FR-N1-GC- BI-AN	€ 949,00	€ 972,00
E	E		€ 1.142,00	€ 1.165,00
G	G	TC	€ 1.055,00	€ 1.078,00
H*	H*		€ 904,00	€ 927,00
TC**	TC**		€ 821,00	€ 844,00

\*\*TC = Minimum order 10 pcs each fabric colour. Feasibility to be approved  
TC = Ordine minimo 10 pz per colore/tessuto. Fattibilità da valutare

\*Excluding / Escluso C36÷C39, C60÷C64, C90÷C95, H120÷H127

For fabrics see page 367  
Per i tessuti si veda a p. 367

PACKING / Imballo



FABRIC REQUIRED / Fabbisogno tessuto  
1pc: Lin Mtrs 2,00 (h 1,40)

TECHNICAL DETAILS / Dettagli tecnici

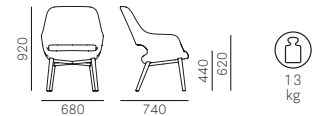

SAFETY, STRENGTH and DURABILITY TESTS  
Prove di sicurezza, resistenza e durata  
EN 1728:2012+AC2013  
EN 16139:2013 level 2

FINISHES / Finiture

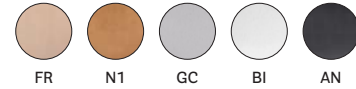

## Babila Comfort 2789



SEAT Sedile	BACK Schienale	WHITE/BLACK POWDER COATED Verniciato bianco/nero	POLISHED ALUMINIUM Alluminio lucidato	TITANIUM Titanio
C*	C*	€ 943,00	€ 966,00	€ 1.088,00
D40÷D44 D120÷D123	D40÷D44 D120÷D123	€ 1.013,00	€ 1.036,00	€ 1.157,00
E	E	€ 1.205,00	€ 1.228,00	€ 1.350,00
G	G	€ 1.119,00	€ 1.142,00	€ 1.263,00
H*	H*	€ 968,00	€ 991,00	€ 1.112,00
TC**	TC**	€ 884,00	€ 907,00	€ 1.028,00

\*\*TC = Minimum order 10 pcs each fabric colour. Feasibility to be approved  
TC = Ordine minimo 10 pz per colore/tessuto. Fattibilità da valutare

\*Excluding / Escluso C36÷C39, C60÷C64, C90÷C95, H120÷H127

For fabrics see page 367  
Per i tessuti si veda a p. 367

PACKING / Imballo



FABRIC REQUIRED / Fabbisogno tessuto  
1pc: Lin Mtrs 2,00 (h 1,40)

TECHNICAL DETAILS / Dettagli tecnici

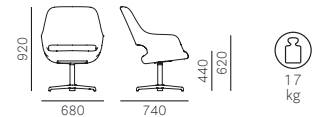

## Babila Twist 2795



SEAT Sedile	BACK Schienale	FRAME Telaio	POWDER COATED Verniciato
D22÷D26 D80÷D89 D100÷D105 D110÷D115 D130÷D133	Ø 16 + Cord/Corda	Ø 20	€ 460,00

For fabrics see page 367  
Per i tessuti si veda a p. 367

CORD FINISHES / Finiture corda



PACKING / Imballo



TECHNICAL DETAILS / Dettagli tecnici



SAFETY, STRENGTH and DURABILITY TESTS  
Prove di sicurezza, resistenza e durata  
EN 1728:2012+AC2013  
EN 16139:2013 level 2

For colours and finishes see at page 362  
Per colori e finiture vedere da pagina 362

## Babila XL 2734RM



SEAT Sedile	BACK Schienale	FRAME Telaio	POWDER COATED Verniciato	CHROMED Cromato	OUTDOOR FINISHES Finiture per esterno
PPL	PPL	Ø 16	€ 109,00	€ 109,00	€ 120,00

PPL FINISHES / Finiture PPL



PACKING / Imballo



TECHNICAL DETAILS / Dettagli tecnici

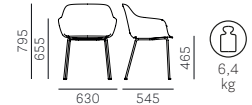

SAFETY, STRENGTH and DURABILITY TESTS  
Prove di sicurezza, resistenza e durata  
EN 1728:2012+AC2013  
EN 16139:2013 level 2



## Babila XL 2744RM



SEAT Sedile	BACK Schienale	FRAME Telaio	POWDER COATED Verniciato	CHROMED Cromato
PPL	PPL	Ø 11	€ 115,00	€ 115,00

PPL FINISHES / Finiture PPL



PACKING / Imballo



TECHNICAL DETAILS / Dettagli tecnici

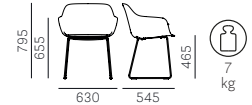

SAFETY, STRENGTH and DURABILITY TESTS  
Prove di sicurezza, resistenza e durata  
EN 1728:2012+AC2013  
EN 16139:2013 level 2



## Babila XL 2754RM



SEAT Sedile	BACK Schienale	FRAME Telaio	ASH Frassino	ASH STAINED ON SAMPLE Frassino tinto campione
PPL	PPL	FR-N1-AN  TC	€ 168,00	€ 190,00

PPL FINISHES / Finiture PPL



WOODEN FINISHES / Finiture legno



For colours and finishes see at page 362  
Per colori e finiture vedere da pagina 362

PACKING / Imballo



TECHNICAL DETAILS / Dettagli tecnici

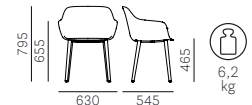

SAFETY, STRENGTH and DURABILITY TESTS  
Prove di sicurezza, resistenza e durata  
EN 1728:2012+AC2013  
EN 16139:2013 level 2



## Babila XL 2734



SEAT Sedile	BACK Schienale	FRAME Telaio	POWDER COATED Verniciato	CHROMED Cromato	OUTDOOR FINISHES Finiture per esterno
PPL	PPL	Ø 16	€ 109,00	€ 109,00	€ 120,00

PPL FINISHES / Finiture PPL



PACKING / Imballo



TECHNICAL DETAILS / Dettagli tecnici

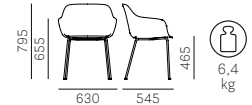

SAFETY, STRENGTH and DURABILITY TESTS  
Prove di sicurezza, resistenza e durata  
EN 1728:2012+AC2013  
EN 16139:2013 level 2



## Babila XL 2744



SEAT Sedile	BACK Schienale	FRAME Telaio	POWDER COATED Verniciato	CHROMED Cromato
PPL	PPL	Ø 11	€ 115,00	€ 115,00

PPL FINISHES / Finiture PPL



PACKING / Imballo



TECHNICAL DETAILS / Dettagli tecnici

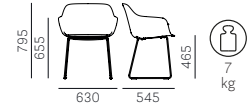

SAFETY, STRENGTH and DURABILITY TESTS  
Prove di sicurezza, resistenza e durata  
EN 1728:2012+AC2013  
EN 16139:2013 level 2



## Babila XL 2754



SEAT Sedile	BACK Schienale	FRAME Telaio	ASH Frassino	ASH STAINED ON SAMPLE Frassino tinto campione
PPL	PPL	FR-N1-AN  TC	€ 168,00	€ 190,00

PPL FINISHES / Finiture PPL



WOODEN FINISHES / Finiture legno



For colours and finishes see at page 362  
Per colori e finiture vedere da pagina 362

PACKING / Imballo



TECHNICAL DETAILS / Dettagli tecnici

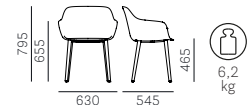

SAFETY, STRENGTH and DURABILITY TESTS  
Prove di sicurezza, resistenza e durata  
EN 1728:2012+AC2013  
EN 16139:2013 level 2



## Babila XL 2732

SOFT



SEAT Sedile	BACK Schienale	FRAME Telaio	POWDER COATED Verniciato	GOLD LACQUERED Laccato oro	CHROMED Cromato
C83+C89; C100+C101 C110+C122 C210+C217	C83+C89; C100+C101 C110+C122 C210+C217		€ 412,00	€ 470,00	€ 412,00
D40+D44	D40+D44		€ 459,00	€ 517,00	€ 459,00
E	E	Ø 16	€ 533,00	€ 591,00	€ 533,00
G*	G*		€ 533,00	€ 591,00	€ 533,00
H40+H53 H120+H127	H40+H53 H120+H127		€ 428,00	€ 486,00	€ 428,00
H60	H60				
TC**	TC**		€ 372,00	€ 430,00	€ 372,00

\*\*TC = Minimum order 10 pcs each fabric colour. Feasibility to be approved  
TC = Ordine minimo 10 pz per colore/tessuto. Fattibilità da valutare

\*Excluding / Escluso G150+G156, G170+G176; G210+G213

For fabrics see page 367  
Per i tessuti si veda a p. 367

PACKING / Imballo



FABRIC REQUIRED / Fabbisogno tessuto  
1pc: Lin Mtrs 1,50 (h 1,40)

TECHNICAL DETAILS / Dettagli tecnici



SAFETY, STRENGTH and DURABILITY TESTS  
Prove di sicurezza, resistenza e durata  
EN 1728:2012+AC2013  
EN 16139:2013 level 2

## Babila XL 2742

SOFT



SEAT Sedile	BACK Schienale	FRAME Telaio	POWDER COATED Verniciato	CHROMED Cromato
C83+C89; C100+C101 C110+C122 C210+C217	C83+C89; C100+C101 C110+C122 C210+C217		€ 418,00	€ 418,00
D40+D44	D40+D44		€ 465,00	€ 465,00
E	E	Ø 11	€ 539,00	€ 539,00
G*	G*		€ 539,00	€ 539,00
H40+H53 H120+H127	H40+H53 H120+H127		€ 434,00	€ 434,00
H60	H60			
TC**	TC**		€ 378,00	€ 378,00

\*\*TC = Minimum order 10 pcs each fabric colour. Feasibility to be approved  
TC = Ordine minimo 10 pz per colore/tessuto. Fattibilità da valutare

\*Excluding / Escluso G150+G156, G170+G176; G210+G213

For fabrics see page 367  
Per i tessuti si veda a p. 367

PACKING / Imballo



FABRIC REQUIRED / Fabbisogno tessuto  
1pc: Lin Mtrs 1,50 (h 1,40)

TECHNICAL DETAILS / Dettagli tecnici



SAFETY, STRENGTH and DURABILITY TESTS  
Prove di sicurezza, resistenza e durata  
EN 1728:2012+AC2013  
EN 16139:2013 level 2

## Babila XL 2752

SOFT



SEAT Sedile	BACK Schienale	FRAME Telaio	ASH Frassino	ASH STAINED ON SAMPLE Frassino tinto campione
C83+C89; C100+C101 C110+C122 C210+C217	C83+C89; C100+C101 C110+C122 C210+C217		€ 473,00	€ 494,00
D40+D44	D40+D44	FR-N1-AN	€ 520,00	€ 541,00
E	E		€ 594,00	€ 615,00
G*	G*	TC	€ 594,00	€ 615,00
H40+H53 H120+H127	H40+H53 H120+H127		€ 489,00	€ 510,00
H60	H60			
TC**	TC**		€ 433,00	€ 454,00

\*\*TC = Minimum order 10 pcs each fabric colour. Feasibility to be approved  
TC = Ordine minimo 10 pz per colore/tessuto. Fattibilità da valutare

FINISHES / Finiture



\*Excluding / Escluso G150+G156, G170+G176; G210+G213

For fabrics see page 367  
Per i tessuti si veda a p. 367

PACKING / Imballo



FABRIC REQUIRED / Fabbisogno tessuto  
1pc: Lin Mtrs 1,50 (h 1,40)

TECHNICAL DETAILS / Dettagli tecnici



SAFETY, STRENGTH and DURABILITY TESTS  
Prove di sicurezza, resistenza e durata  
EN 1728:2012+AC2013  
EN 16139:2013 level 2

For colours and finishes see at page 362  
Per colori e finiture vedere da pagina 362



## Babila XL 2733R

Armchair with polypropylene shell and removable covering  
Poltrona con scocca in polipropilene e imbottitura sfoderabile



SEAT Sedile	BACK Schienale	FRAME Telaio	POWDER COATED Verniciato	GOLD LACQUERED Laccato oro	CHROMED Cromato
C36+C39 C83+C89; C100+C101 C110+C122 C210+C217	C36+C39 C83+C89; C100+C101 C110+C122 C210+C217	Ø 16	€ 366,00	€ 424,00	€ 366,00
D40+D44	D40+D44		€ 421,00	€ 479,00	€ 421,00
E	E		€ 529,00	€ 586,00	€ 529,00
G*	G*		€ 507,00	€ 564,00	€ 507,00
H40+H53 H120+H127 H60	H40+H53 H120+H127 H60		€ 385,00	€ 443,00	€ 385,00

\*Excluding / Escluso G100+G102

PPL FINISHES / Finiture PPL



RG

SAFETY, STRENGTH and DURABILITY TESTS  
Prove di sicurezza, resistenza e durata  
EN 1728:2012+AC2013  
EN 16139:2013 level 2

For fabrics see page 367  
Per i tessuti si veda a p. 367

PACKING / Imballo



TECHNICAL DETAILS / Dettagli tecnici

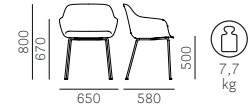

## Babila XL 2743R

Armchair with polypropylene shell and removable covering  
Poltrona con scocca in polipropilene e imbottitura sfoderabile



SEAT Sedile	BACK Schienale	FRAME Telaio	POWDER COATED Verniciato	CHROMED Cromato
C36+C39 C83+C89; C100+C101 C110+C122 C210+C217	C36+C39 C83+C89; C100+C101 C110+C122 C210+C217	Ø 11	€ 372,00	€ 372,00
D40+D44	D40+D44		€ 427,00	€ 427,00
E	E		€ 534,00	€ 534,00
G*	G*		€ 512,00	€ 512,00
H40+H53 H120+H127 H60	H40+H53 H120+H127 H60		€ 391,00	€ 391,00

\*Excluding / Escluso G100+G102

PPL FINISHES / Finiture PPL



RG

SAFETY, STRENGTH and DURABILITY TESTS  
Prove di sicurezza, resistenza e durata  
EN 1728:2012+AC2013  
EN 16139:2013 level 2

For fabrics see page 367  
Per i tessuti si veda a p. 367

PACKING / Imballo



TECHNICAL DETAILS / Dettagli tecnici

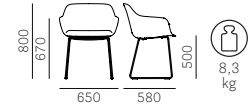

## Babila XL 2753R

Armchair with polypropylene shell and removable covering  
Poltrona con scocca in polipropilene e imbottitura sfoderabile



SEAT Sedile	BACK Schienale	FRAME Telaio	ASH Frassino	ASH STAINED ON SAMPLE Frassino tinto campione
C36+C39 C83+C89; C100+C101 C110+C122 C210+C217	C36+C39 C83+C89; C100+C101 C110+C122 C210+C217	FR-N1-AN TC	€ 427,00	€ 450,00
D40+D44	D40+D44		€ 482,00	€ 506,00
E	E		€ 590,00	€ 613,00
G*	G*		€ 568,00	€ 591,00
H40+H53 H120+H127 H60	H40+H53 H120+H127 H60		€ 447,00	€ 470,00

\*Excluding / Escluso G100+G102

PPL FINISHES / Finiture PPL



RG

WOODEN FINISHES / Finiture legno



FR

N1

AN

PACKING / Imballo



Minimum order q.ty: 20 pcs  
Ordine minimo: 20pz

TECHNICAL DETAILS / Dettagli tecnici

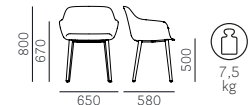

SAFETY, STRENGTH and DURABILITY TESTS  
Prove di sicurezza, resistenza e durata  
EN 1728:2012+AC2013  
EN 16139:2013 level 2

For fabrics see page 367  
Per i tessuti si veda a p. 367

For colours and finishes see at page 362  
Per colori e finiture vedere da pagina 362



## Babila XL 2734/3

Fabric covering only  
Solo vestina



SEAT Sedile	BACK Schienale	FABRIC Tessuto
C36+C39 C83+C89; C100+C101 C110+C122 C210+C217 D40+D44	C36+C39 C83+C89; C100+C101 C110+C122 C210+C217 D40+D44	<b>€ 251,00</b>
E	E	<b>€ 307,00</b>
G*	G*	<b>€ 414,00</b>
H40+H53 H120+H127 H60	H40+H53 H120+H127 H60	<b>€ 392,00</b>
*Excluding / Escluso G100+G102		<b>€ 271,00</b>

For fabrics see page 367  
Per i tessuti si veda a p. 367

PACKING / Imballo



TECHNICAL DETAILS / Dettagli tecnici



## Blitz 640



SEAT Sedile	BACK Schienale	FRAME Telaio	POLYCARBONATE Policarbonato
PC	PC	PC	<b>€ 120,00</b>

PC FINISHES / Finiture PC

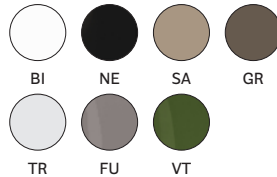

SAFETY, STRENGTH and DURABILITY TESTS  
Prove di sicurezza, resistenza e durata  
EN 1728:2000

PACKING / Imballo



TECHNICAL DETAILS / Dettagli tecnici

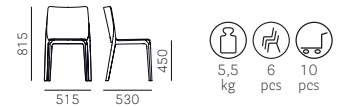

## Blitz 640/CL1

Fire retardant version  
Versione ignifuga



SEAT Sedile	BACK Schienale	FRAME Telaio	POLYCARBONATE Policarbonato
PC	PC	PC	<b>€ 139,00</b>

Minimum order 300 pcs each colour  
Ordine minimo 300 pz per colore

PC FINISHES / Finiture PC



SAFETY, STRENGTH and DURABILITY TESTS  
Prove di sicurezza, resistenza e durata  
EN 1728:2000

PACKING / Imballo



TECHNICAL DETAILS / Dettagli tecnici

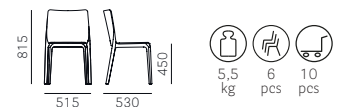

## Blitz 640.3

Cushion only  
Solo cuscino



SEAT Sedile	FABRIC Tessuto
A	€ 59,00
C	€ 65,00
G	€ 83,00
H *	€ 66,00

\*Excluding / Escluso H140+H143

For fabrics see page 367  
Per i tessuti si veda a p. 367

PACKING / Imballo



TECHNICAL DETAILS / Dettagli tecnici

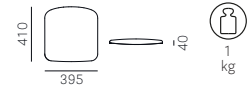

## Blume 2950



SEAT Sedile	BACK Schienale	FRAME Telaio	ANODIZED ALUMINIUM Alluminio anodizzato			
			BRUSHED BRONZE Bronzo satinato	BRASS Ottone	GREY Grigio	BLACK Nero
C210+C217	C210+C217	Ø 19	€ 599,00	€ 599,00	€ 599,00	€ 599,00
D120+D123	D120+D123		€ 636,00	€ 636,00	€ 636,00	€ 636,00
E	E		€ 692,00	€ 692,00	€ 692,00	€ 692,00
G *	G *		€ 692,00	€ 692,00	€ 692,00	€ 692,00
H *	H *		€ 612,00	€ 612,00	€ 612,00	€ 612,00
TC **	TC **		€ 569,00	€ 569,00	€ 569,00	€ 569,00

\*\*TC = Minimum order 10 pcs each fabric colour. Feasibility to be approved  
TC = Ordine minimo 10 pz per colore/tessuto. Fattibilità da valutare

\*Excluding / Escluso G100+G102, H20+H35; H100+H108, H82+H89

For fabrics see page 367  
Per i tessuti si veda a p. 367

PACKING / Imballo



TECHNICAL DETAILS / Dettagli tecnici

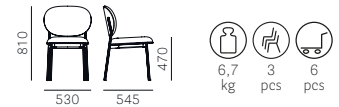

SAFETY, STRENGTH and DURABILITY TESTS  
Prove di sicurezza, resistenza e durata  
EN 1728:2012+AC2013  
EN 16139:2013 level 2

FINISHES / Finiture

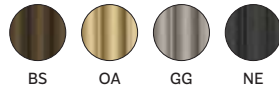

## Blume 2951

LOUNGE



SEAT Sedile	BACK Schienale	FRAME Telaio	ANODIZED ALUMINIUM Alluminio anodizzato			
			BRUSHED BRONZE Bronzo satinato	BRASS Ottone	GREY Grigio	BLACK Nero
C210+C217	C210+C217	Ø 19	€ 624,00	€ 624,00	€ 624,00	€ 624,00
D120+D123	D120+D123		€ 663,00	€ 663,00	€ 663,00	€ 663,00
E	E		€ 721,00	€ 721,00	€ 721,00	€ 721,00
G *	G *		€ 721,00	€ 721,00	€ 721,00	€ 721,00
H *	H *		€ 638,00	€ 638,00	€ 638,00	€ 638,00
TC **	TC **		€ 592,00	€ 592,00	€ 592,00	€ 592,00

\*\*TC = Minimum order 10 pcs each fabric colour. Feasibility to be approved  
TC = Ordine minimo 10 pz per colore/tessuto. Fattibilità da valutare

\*Excluding / Escluso G100+G102, H20+H35; H100+H108, H82+H89

For fabrics see page 367  
Per i tessuti si veda a p. 367

PACKING / Imballo



TECHNICAL DETAILS / Dettagli tecnici



SAFETY, STRENGTH and DURABILITY TESTS  
Prove di sicurezza, resistenza e durata  
EN 1728:2012+AC2013  
EN 16139:2013 level 2

FINISHES / Finiture

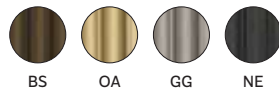

FABRIC REQUIRED / Fabbisogno tessuto  
1 pc: Lin Mtrs 1,80 (h 1,40)

## Blume 2955



SEAT Sedile	BACK Schienale	FRAME Telaio	ANODIZED ALUMINIUM Alluminio anodizzato			
			BRUSHED BRONZE Bronzo satinato	BRASS Ottone	GREY Grigio	BLACK Nero
C210+C217	C210+C217	Ø 19	€ 772,00	€ 772,00	€ 772,00	€ 772,00
D120+D123	D120+D123		€ 809,00	€ 809,00	€ 809,00	€ 809,00
E	E		€ 865,00	€ 865,00	€ 865,00	€ 865,00
G*	G*		€ 865,00	€ 865,00	€ 865,00	€ 865,00
H*	H*		€ 785,00	€ 785,00	€ 785,00	€ 785,00
TC**	TC**		€ 741,00	€ 741,00	€ 741,00	€ 741,00

\*\*TC = Minimum order 10 pcs each fabric colour. Feasibility to be approved  
TC = Ordine minimo 10 pz per colore/tessuto. Fattibilità da valutare

\*Excluding / Escluso G100+G102, H20+H35; H100+H108, H82+H89

For fabrics see page 367  
Per i tessuti si veda a p. 367

### FINISHES / Finiture

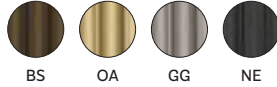

### PACKING / Imballo



FABRIC REQUIRED / Fabbisogno tessuto  
1pc: Lin Mtrs 1,60 (h 1,40)

### TECHNICAL DETAILS / Dettagli tecnici

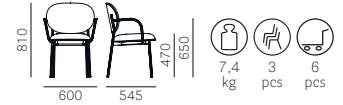

## Blume 2959

LOUNGE



SEAT Sedile	BACK Schienale	FRAME Telaio	ANODIZED ALUMINIUM Alluminio anodizzato			
			BRUSHED BRONZE Bronzo satinato	BRASS Ottone	GREY Grigio	BLACK Nero
C210+C217	C210+C217	Ø 19	€ 819,00	€ 819,00	€ 819,00	€ 819,00
D120+D123	D120+D123		€ 857,00	€ 857,00	€ 857,00	€ 857,00
E	E		€ 915,00	€ 915,00	€ 915,00	€ 915,00
G*	G*		€ 915,00	€ 915,00	€ 915,00	€ 915,00
H*	H*		€ 832,00	€ 832,00	€ 832,00	€ 832,00
TC**	TC**		€ 787,00	€ 787,00	€ 787,00	€ 787,00

\*\*TC = Minimum order 10 pcs each fabric colour. Feasibility to be approved  
TC = Ordine minimo 10 pz per colore/tessuto. Fattibilità da valutare

\*Excluding / Escluso G100+G102, H20+H35; H100+H108, H82+H89

For fabrics see page 367  
Per i tessuti si veda a p. 367

### FINISHES / Finiture

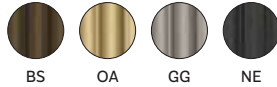

### PACKING / Imballo



FABRIC REQUIRED / Fabbisogno tessuto  
1pc: Lin Mtrs 1,80 (h 1,40)

### TECHNICAL DETAILS / Dettagli tecnici





## Box 747



SEAT Sedile	BACK Schienale	FRAME Telaio	OAK Rovere	OAK STAINED ON SAMPLE Rovere tinto campione
			SATINIZED Satinato	SATINIZED Satinato
A	A	20x20	€ 447,00	€ 469,00
C*	C*		€ 475,00	€ 497,00
G	G		€ 553,00	€ 575,00
H*	H*		€ 479,00	€ 501,00
P*	P*		€ 580,00	€ 602,00
TC**	TC**		€ 447,00	€ 469,00
CL**	CL**		€ 453,00	€ 475,00

\*\*TC/CL = Minimum order 10 pcs each fabric colour  
TC/CL = Ordine minimo 10 pz per colore/tessuto

\*Excluding / Escluso C36+C39, H140+H143, PBS-PCO-PMS-PVE

### FINISHES / Finiture



For fabrics see page 367  
Per i tessuti si veda a p. 367

### PACKING / Imballo



FABRIC REQUIRED / Fabbisogno tessuto  
1 pc: Lin Mtrs 1,05 (h 1,40)

Minimum order q.ty: 20 pcs  
Ordine minimo: 20pz

### TECHNICAL DETAILS / Dettagli tecnici

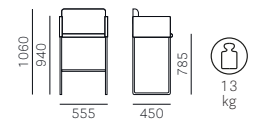

## Box 741

LOUNGE



SEAT Sedile	BACK Schienale	FRAME Telaio	OAK Rovere	OAK STAINED ON SAMPLE Rovere tinto campione
			SATINIZED Satinato	SATINIZED Satinato
A	A	20x20	€ 457,00	€ 479,00
C*	C*		€ 495,00	€ 517,00
G	G		€ 583,00	€ 605,00
H*	H*		€ 495,00	€ 517,00
P*	P*		€ 634,00	€ 656,00
TC**	TC**		€ 457,00	€ 479,00
CL**	CL**		€ 462,00	€ 484,00

\*\*TC/CL = Minimum order 10 pcs each fabric colour  
TC/CL = Ordine minimo 10 pz per colore/tessuto

\*Excluding / Escluso C36+C39, H140+H143, PBS-PCO-PMS-PVE

### FINISHES / Finiture



For fabrics see page 367  
Per i tessuti si veda a p. 367

### PACKING / Imballo



FABRIC REQUIRED / Fabbisogno tessuto  
1 pc: Lin Mtrs 1,30 (h 1,40)

Minimum order q.ty: 20 pcs  
Ordine minimo: 20pz

### TECHNICAL DETAILS / Dettagli tecnici

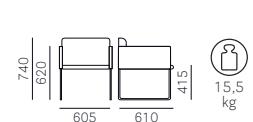

SAFETY, STRENGTH and DURABILITY TESTS  
Prove di sicurezza, resistenza e durata  
EN 1728:2000

## Box 746

SOFA



SEAT Sedile	BACK Schienale	FRAME Telaio	OAK Rovere
			SATINIZED Satinato
A	A	20x20	€ 768,00
C*	C*		€ 823,00
G	G		€ 979,00
H*	H*		€ 832,00
P*	P*		€ 1.034,00
TC**	TC**		€ 768,00
CL**	CL**		€ 774,00

\*\*TC/CL = Minimum order 10 pcs each fabric colour  
TC/CL = Ordine minimo 10 pz per colore/tessuto

\*Excluding / Escluso C36+C39, H140+H143, PBS-PCO-PMS-PVE

### FINISHES / Finiture

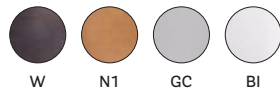

For fabrics see page 367  
Per i tessuti si veda a p. 367

### PACKING / Imballo



FABRIC REQUIRED / Fabbisogno tessuto  
1 pc: Lin Mtrs 2 (h 1,40)

### TECHNICAL DETAILS / Dettagli tecnici

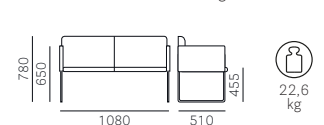

## Brera 380



SEAT Sedile	BACK Schienale	FRAME Telaio	OAK Rovere	OAK STAINED ON SAMPLE Rovere tinto campione
RS-W-N1- GC-BI	RS-W-N1- GC-BI	RS-W-N1- GC-BI	<b>€ 249,00</b>	
TC	TC	TC		<b>€ 272,00</b>

### FINISHES / Finiture



### PACKING / Imballo



### TECHNICAL DETAILS / Dettagli tecnici

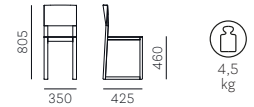

**SAFETY, STRENGTH and DURABILITY TESTS**  
Prove di sicurezza, resistenza e durata  
EN 1728:2000



## Brera 380



SEAT Sedile	BACK Schienale	FRAME Telaio	OAK Rovere
BL2 AZ1 VE2 VE1 RB RA MO MC	BL2 AZ1 VE2 VE1 RB RA MO MC	BL2 AZ1 VE2 VE1 RB RA MO MC	<b>€ 260,00</b> Lacquered with visible grains Laccato a poro aperto

### FINISHES / Finiture



### PACKING / Imballo



### TECHNICAL DETAILS / Dettagli tecnici

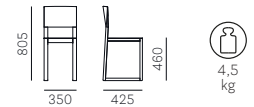

**SAFETY, STRENGTH and DURABILITY TESTS**  
Prove di sicurezza, resistenza e durata  
EN 1728:2000



## Brera 380



SEAT Sedile	BACK Schienale	FRAME Telaio	OAK Rovere
V101- V102-V103	V101- V102-V103	V101- V102-V103	<b>€ 283,00</b> Vintage / Anticato

### FINISHES / Finiture



### PACKING / Imballo



### TECHNICAL DETAILS / Dettagli tecnici

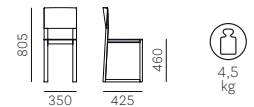

**SAFETY, STRENGTH and DURABILITY TESTS**  
Prove di sicurezza, resistenza e durata  
EN 1728:2000



## Brera 382



SEAT Sedile	BACK Schienale	FRAME Telaio	OAK Rovere	OAK STAINED ON SAMPLE Rovere tinto campione
RS-W-N1- GC-BI	RS-W-N1- GC-BI	H650	<b>€ 303,00</b>	
TC	TC			<b>€ 327,00</b>

### FINISHES / Finiture



### PACKING / Imballo



### TECHNICAL DETAILS / Dettagli tecnici

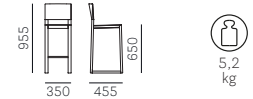

## Brera 382



SEAT Sedile	BACK Schienale	FRAME Telaio	OAK Rovere
BL2 AZ1 VE2 VE1 RB RA MO MC	BL2 AZ1 VE2 VE1 RB RA MO MC	H650	<b>€ 315,00</b> Lacquered with visible grains Laccato a poro aperto

### FINISHES / Finiture



### PACKING / Imballo



### TECHNICAL DETAILS / Dettagli tecnici

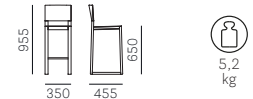

## Brera 382



SEAT Sedile	BACK Schienale	FRAME Telaio	OAK Rovere
V101- V102-V103	V101- V102-V103	H650	<b>€ 338,00</b> Vintage / Anticato

### FINISHES / Finiture



### PACKING / Imballo



### TECHNICAL DETAILS / Dettagli tecnici

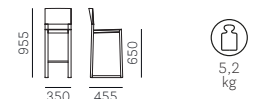

## Brera 386



SEAT Sedile	BACK Schienale	FRAME Telaio	OAK Rovere	OAK STAINED ON SAMPLE Rovere tinto campione
RS-W-N1- GC-BI	RS-W-N1- GC-BI	H740	<b>€ 346,00</b>	
TC	TC			<b>€ 369,00</b>

### FINISHES / Finiture



### PACKING / Imballo



### TECHNICAL DETAILS / Dettagli tecnici

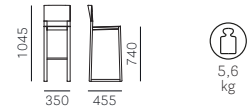

## Brera 386



SEAT Sedile	BACK Schienale	FRAME Telaio	OAK Rovere
BL2 AZ1 VE2 VE1 RB RA MO MC	BL2 AZ1 VE2 VE1 RB RA MO MC	H740	<b>€ 357,00</b> Lacquered with visible grains Laccato a poro aperto

### FINISHES / Finiture



### PACKING / Imballo



### TECHNICAL DETAILS / Dettagli tecnici

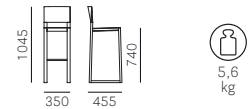

## Brera 386



SEAT Sedile	BACK Schienale	FRAME Telaio	OAK Rovere
V101- V102-V103	V101- V102-V103	H740	<b>€ 381,00</b> Vintage / Anticato

### FINISHES / Finiture



### PACKING / Imballo



### TECHNICAL DETAILS / Dettagli tecnici

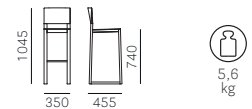

## Brera 383



**SAFETY, STRENGTH and DURABILITY TESTS**  
 Prove di sicurezza, resistenza e durata  
 EN 1728:2012+AC2013  
 EN 16139:2013 level 2

SEAT Sedile	FRAME Telaio	OAK Rovere	OAK STAINED ON SAMPLE Rovere tinto campione
RS-W-N1- GC-BI	H460	<b>€ 191,00</b>	
TC			<b>€ 214,00</b>

**FINISHES / Finiture**



**PACKING / Imballo**



**TECHNICAL DETAILS / Dettagli tecnici**



## Brera 383



**SAFETY, STRENGTH and DURABILITY TESTS**  
 Prove di sicurezza, resistenza e durata  
 EN 1728:2012+AC2013  
 EN 16139:2013 level 2

SEAT Sedile	FRAME Telaio	OAK Rovere
BL2 AZ1 VE2 VE1 RB RA MO MC	H460	<b>€ 203,00</b> Lacquered with visible grains Laccato a poro aperto

**FINISHES / Finiture**



**PACKING / Imballo**



**TECHNICAL DETAILS / Dettagli tecnici**



## Brera 383



**SAFETY, STRENGTH and DURABILITY TESTS**  
 Prove di sicurezza, resistenza e durata  
 EN 1728:2012+AC2013  
 EN 16139:2013 level 2

SEAT Sedile	FRAME Telaio	OAK Rovere
V101- V102-V103	H460	<b>€ 226,00</b> Vintage / Anticato

**FINISHES / Finiture**



**PACKING / Imballo**



**TECHNICAL DETAILS / Dettagli tecnici**



## Brera 387



SEAT Sedile	FRAME Telaio	OAK Rovere	OAK STAINED ON SAMPLE Rovere tinto campione
RS-W-N1- GC-BI	H650	<b>€ 235,00</b>	
TC			<b>€ 258,00</b>

### FINISHES / Finiture



### PACKING / Imballo



### TECHNICAL DETAILS / Dettagli tecnici



**SAFETY, STRENGTH and DURABILITY TESTS**  
 Prove di sicurezza, resistenza e durata  
 EN 1728:2012+AC2013  
 EN 16139:2013 level 2



## Brera 387



SEAT Sedile	FRAME Telaio	OAK Rovere
BL2 AZ1 VE2 VE1 RB RA MO MC	H650	<b>€ 247,00</b> Lacquered with visible grains Laccato a poro aperto

### FINISHES / Finiture



### PACKING / Imballo



### TECHNICAL DETAILS / Dettagli tecnici



**SAFETY, STRENGTH and DURABILITY TESTS**  
 Prove di sicurezza, resistenza e durata  
 EN 1728:2012+AC2013  
 EN 16139:2013 level 2



## Brera 387



SEAT Sedile	FRAME Telaio	OAK Rovere
V101- V102-V103	H650	<b>€ 270,00</b> Vintage / Anticato

### FINISHES / Finiture



### PACKING / Imballo



### TECHNICAL DETAILS / Dettagli tecnici



**SAFETY, STRENGTH and DURABILITY TESTS**  
 Prove di sicurezza, resistenza e durata  
 EN 1728:2012+AC2013  
 EN 16139:2013 level 2



## Brera 388



SEAT Sedile	FRAME Telaio	OAK Rovere	OAK STAINED ON SAMPLE Rovere tinto campione
RS-W-N1- GC-BI	H750	<b>€ 235,00</b>	
TC			<b>€ 258,00</b>

### FINISHES / Finiture



### PACKING / Imballo



### TECHNICAL DETAILS / Dettagli tecnici



**SAFETY, STRENGTH and DURABILITY TESTS**  
 Prove di sicurezza, resistenza e durata  
 EN 1728:2012+AC2013  
 EN 16139:2013 level 2



## Brera 388



SEAT Sedile	FRAME Telaio	OAK Rovere
BL2 AZ1 VE2 VE1 RB RA MO MC	H750	<b>€ 247,00</b> Lacquered with visible grains Laccato a poro aperto

### FINISHES / Finiture



### PACKING / Imballo



### TECHNICAL DETAILS / Dettagli tecnici

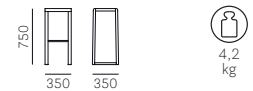

**SAFETY, STRENGTH and DURABILITY TESTS**  
 Prove di sicurezza, resistenza e durata  
 EN 1728:2012+AC2013  
 EN 16139:2013 level 2



## Brera 388



SEAT Sedile	FRAME Telaio	OAK Rovere
V101- V102-V103	H750	<b>€ 270,00</b> Vintage / Anticato

### FINISHES / Finiture



### PACKING / Imballo



### TECHNICAL DETAILS / Dettagli tecnici

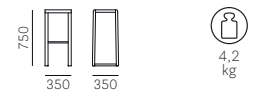

**SAFETY, STRENGTH and DURABILITY TESTS**  
 Prove di sicurezza, resistenza e durata  
 EN 1728:2012+AC2013  
 EN 16139:2013 level 2



## Buddy 210



SEAT Sedile	FRAME Telaio	POWDER COATED Verniciato	ANTIQU BRASS Ottone anticato
C		€ 391,00	€ 457,00
D40÷D44		€ 438,00	€ 504,00
E		€ 510,00	€ 576,00
G	550x550 H400	€ 510,00	€ 576,00
H *		€ 407,00	€ 473,00
N01÷N08 N30÷N38		€ 543,00	€ 609,00
TC **		€ 352,00	€ 418,00

\*\*TC = Minimum order 10 pcs each fabric colour  
TC = Ordine minimo 10 pz per colore/tessuto

\*Excluding / Escluso H140+H143

For fabrics see page 367  
Per i tessuti si veda a p. 367

PACKING / Imballo



FABRIC REQUIRED / Fabbisogno tessuto  
1pc: Lin Mtrs 1,35 (h 1,40)

TECHNICAL DETAILS / Dettagli tecnici

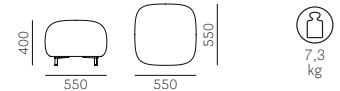

## Buddy 211



SEAT Sedile	FRAME Telaio	POWDER COATED Verniciato	ANTIQU BRASS Ottone anticato
C		€ 391,00	€ 457,00
D40÷D44		€ 438,00	€ 504,00
E		€ 510,00	€ 576,00
G	550x550 H450	€ 510,00	€ 576,00
H *		€ 407,00	€ 473,00
N01÷N08 N30÷N38		€ 543,00	€ 609,00
TC **		€ 352,00	€ 418,00

\*\*TC = Minimum order 10 pcs each fabric colour  
TC = Ordine minimo 10 pz per colore/tessuto

\*Excluding / Escluso H140+H143

For fabrics see page 367  
Per i tessuti si veda a p. 367

PACKING / Imballo



FABRIC REQUIRED / Fabbisogno tessuto  
1pc: Lin Mtrs 1,35 (h 1,40)

TECHNICAL DETAILS / Dettagli tecnici

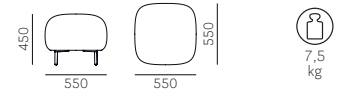

## Buddy 212



SEAT Sedile	FRAME Telaio	POWDER COATED Verniciato	ANTIQU BRASS Ottone anticato
C		€ 632,00	€ 744,00
D40÷D44		€ 728,00	€ 840,00
E		€ 876,00	€ 988,00
G	900x900 H400	€ 876,00	€ 988,00
H *		€ 665,00	€ 777,00
N01÷N08 N30÷N38		€ 946,00	€ 1.058,00
TC **		€ 548,00	€ 660,00

\*\*TC = Minimum order 10 pcs each fabric colour  
TC = Ordine minimo 10 pz per colore/tessuto

\*Excluding / Escluso H140+H143

For fabrics see page 367  
Per i tessuti si veda a p. 367

PACKING / Imballo



FABRIC REQUIRED / Fabbisogno tessuto  
1pc: Lin Mtrs 2,80 (h 1,40)

TECHNICAL DETAILS / Dettagli tecnici

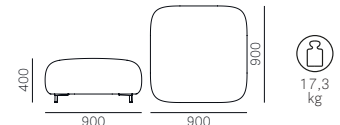

For colours and finishes see at page 362  
Per colori e finiture vedere da pagina 362



## Buddy 213



SEAT Sedile	FRAME Telaio	POWDER COATED Verniciato	ANTIQU BRASS Ottone anticato
C		€ 632,00	€ 744,00
D40÷D44		€ 728,00	€ 840,00
E		€ 876,00	€ 988,00
G	900x900 H450	€ 876,00	€ 988,00
H *		€ 665,00	€ 777,00
N01÷N08 N30÷N38		€ 946,00	€ 1.058,00
TC **		€ 548,00	€ 660,00

\*\*TC = Minimum order 10 pcs each fabric colour  
TC = Ordine minimo 10 pz per colore/tessuto

\*Excluding / Escluso H140+H143

For fabrics see page 367  
Per i tessuti si veda a p. 367

PACKING / Imballo



FABRIC REQUIRED / Fabbisogno tessuto  
1pc: Lin Mtrs 2,80 (h 1,40)

TECHNICAL DETAILS / Dettagli tecnici

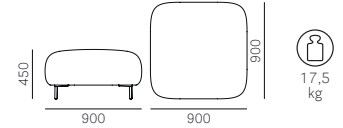

## Buddy 214



SEAT Sedile	FRAME Telaio	POWDER COATED Verniciato	ANTIQU BRASS Ottone anticato
C		€ 562,00	€ 674,00
D40÷D44		€ 632,00	€ 744,00
E		€ 738,00	€ 850,00
G	1100x550 H400	€ 738,00	€ 850,00
H *		€ 586,00	€ 698,00
N01÷N08 N30÷N38		€ 788,00	€ 900,00
TC **		€ 503,00	€ 615,00

\*\*TC = Minimum order 10 pcs each fabric colour  
TC = Ordine minimo 10 pz per colore/tessuto

\*Excluding / Escluso H140+H143

For fabrics see page 367  
Per i tessuti si veda a p. 367

PACKING / Imballo



FABRIC REQUIRED / Fabbisogno tessuto  
1pc: Lin Mtrs 2,00 (h 1,40)

TECHNICAL DETAILS / Dettagli tecnici

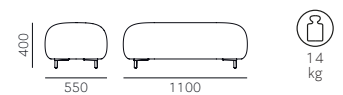

## Buddy 215



SEAT Sedile	FRAME Telaio	POWDER COATED Verniciato	ANTIQU BRASS Ottone anticato
C		€ 562,00	€ 674,00
D40÷D44		€ 632,00	€ 744,00
E		€ 738,00	€ 850,00
G	1100x550 H450	€ 738,00	€ 850,00
H *		€ 586,00	€ 698,00
N01÷N08 N30÷N38		€ 788,00	€ 900,00
TC **		€ 503,00	€ 615,00

\*\*TC = Minimum order 10 pcs each fabric colour  
TC = Ordine minimo 10 pz per colore/tessuto

\*Excluding / Escluso H140+H143

For fabrics see page 367  
Per i tessuti si veda a p. 367

PACKING / Imballo



FABRIC REQUIRED / Fabbisogno tessuto  
1pc: Lin Mtrs 2,00 (h 1,40)

TECHNICAL DETAILS / Dettagli tecnici

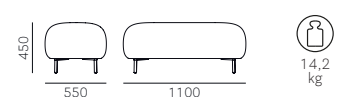

For colours and finishes see at page 362  
Per colori e finiture vedere da pagina 362

## Buddy 210S

SEAT Sedile	BACK Schienale	FRAME Telaio	POWDER COATED Verniciato	ANTIQUE BRASS Ottone anticato
C	C		€ 707,00	€ 807,00
D40÷D44	D40÷D44		€ 785,00	€ 885,00
E	E		€ 904,00	€ 1.004,00
G	G	550x620 H400	€ 904,00	€ 1.004,00
H*	H*		€ 734,00	€ 834,00
N01÷N08 N30÷N38	N01÷N08 N30÷N38		€ 960,00	€ 1.060,00
TC**	TC**		€ 641,00	€ 741,00

\*\*TC = Minimum order 10 pcs each fabric colour. Feasibility to be approved  
TC = Ordine minimo 10 pz per colore/tessuto. Fattibilità da valutare

\*Excluding / Escluso H140+H143

For fabrics see page 367  
Per i tessuti si veda a p. 367

PACKING / Imballo



FABRIC REQUIRED / Fabbisogno tessuto  
1pc: Lin Mtrs 2,35 (h 1,40)

TECHNICAL DETAILS / Dettagli tecnici

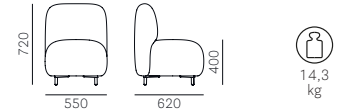

## Buddy 211S

SEAT Sedile	BACK Schienale	FRAME Telaio	POWDER COATED Verniciato	ANTIQUE BRASS Ottone anticato
C	C		€ 707,00	€ 807,00
D40÷D44	D40÷D44		€ 785,00	€ 885,00
E	E		€ 904,00	€ 1.004,00
G	G	550x620 H450	€ 904,00	€ 1.004,00
H*	H*		€ 734,00	€ 834,00
N01÷N08 N30÷N38	N01÷N08 N30÷N38		€ 960,00	€ 1.060,00
TC**	TC**		€ 641,00	€ 741,00

\*\*TC = Minimum order 10 pcs each fabric colour. Feasibility to be approved  
TC = Ordine minimo 10 pz per colore/tessuto. Fattibilità da valutare

\*Excluding / Escluso H140+H143

For fabrics see page 367  
Per i tessuti si veda a p. 367

PACKING / Imballo



FABRIC REQUIRED / Fabbisogno tessuto  
1pc: Lin Mtrs 2,35 (h 1,40)

TECHNICAL DETAILS / Dettagli tecnici

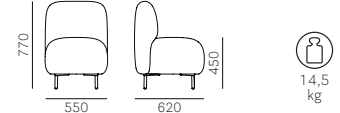

## Buddy 212S

SEAT Sedile	BACK Schienale	FRAME Telaio	POWDER COATED Verniciato	ANTIQUE BRASS Ottone anticato
C	C		€ 1.157,00	€ 1.269,00
D40÷D44	D40÷D44		€ 1.320,00	€ 1.432,00
E	E		€ 1.568,00	€ 1.680,00
G	G	900x970 H400	€ 1.568,00	€ 1.680,00
H*	H*		€ 1.213,00	€ 1.325,00
N01÷N08 N30÷N38	N01÷N08 N30÷N38		€ 1.670,00	€ 1.782,00
TC**	TC**		€ 1.018,00	€ 1.130,00

\*\*TC = Minimum order 10 pcs each fabric colour. Feasibility to be approved  
TC = Ordine minimo 10 pz per colore/tessuto. Fattibilità da valutare

\*Excluding / Escluso H140+H143

For fabrics see page 367  
Per i tessuti si veda a p. 367

PACKING / Imballo



FABRIC REQUIRED / Fabbisogno tessuto  
1pc: Lin Mtrs 3,90 (h 1,40)

TECHNICAL DETAILS / Dettagli tecnici

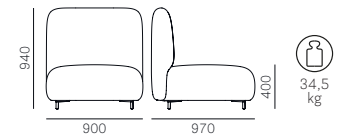

SAFETY, STRENGTH and DURABILITY TESTS  
Prove di sicurezza, resistenza e durata  
EN 1728:2012+AC2013  
EN 16139:2013 level 2

For colours and finishes see at page 362  
Per colori e finiture vedere da pagina 362

## Buddy 213S



SEAT Sedile	BACK Schienale	FRAME Telaio	POWDER COATED Verniciato	ANTIQUE BRASS Ottone anticato
C	C	900x970 H450	€ 1.157,00	€ 1.269,00
D40÷D44	D40÷D44		€ 1.320,00	€ 1.432,00
E	E		€ 1.568,00	€ 1.680,00
G	G		€ 1.568,00	€ 1.680,00
H*	H*		€ 1.213,00	€ 1.325,00
N01÷N08 N30÷N38	N01÷N08 N30÷N38		€ 1.670,00	€ 1.782,00
TC**	TC**		€ 1.018,00	€ 1.130,00

\*\*TC = Minimum order 10 pcs each fabric colour. Feasibility to be approved  
TC = Ordine minimo 10 pz per colore/tessuto. Fattibilità da valutare

\*Excluding / Escluso H140+H143

For fabrics see page 367  
Per i tessuti si veda a p. 367

PACKING / Imballo



FABRIC REQUIRED / Fabbisogno tessuto  
1pc: Lin Mtrs 3,90 (h 1,40)

TECHNICAL DETAILS / Dettagli tecnici

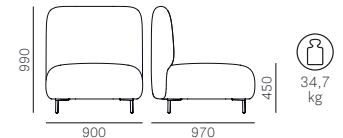

SAFETY, STRENGTH and DURABILITY TESTS  
Prove di sicurezza, resistenza e durata  
EN 1728:2012+AC2013  
EN 16139:2013 level 2

## Buddy 214S



SEAT Sedile	BACK Schienale	FRAME Telaio	POWDER COATED Verniciato	ANTIQUE BRASS Ottone anticato
C	C	1100x620 H400	€ 1.118,00	€ 1.268,00
D40÷D44	D40÷D44		€ 1.239,00	€ 1.389,00
E	E		€ 1.425,00	€ 1.575,00
G	G		€ 1.425,00	€ 1.575,00
H*	H*		€ 1.160,00	€ 1.310,00
N01÷N08 N30÷N38	N01÷N08 N30÷N38		€ 1.510,00	€ 1.660,00
TC**	TC**		€ 1.015,00	€ 1.165,00

\*\*TC = Minimum order 10 pcs each fabric colour. Feasibility to be approved  
TC = Ordine minimo 10 pz per colore/tessuto. Fattibilità da valutare

\*Excluding / Escluso H140+H143

For fabrics see page 367  
Per i tessuti si veda a p. 367

PACKING / Imballo



FABRIC REQUIRED / Fabbisogno tessuto  
1pc: Lin Mtrs 3,50 (h 1,40)

TECHNICAL DETAILS / Dettagli tecnici

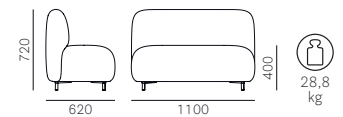

## Buddy 215S



SEAT Sedile	BACK Schienale	FRAME Telaio	POWDER COATED Verniciato	ANTIQUE BRASS Ottone anticato
C	C	1100x620 H450	€ 1.118,00	€ 1.268,00
D40÷D44	D40÷D44		€ 1.239,00	€ 1.389,00
E	E		€ 1.425,00	€ 1.575,00
G	G		€ 1.425,00	€ 1.575,00
H*	H*		€ 1.160,00	€ 1.310,00
N01÷N08 N30÷N38	N01÷N08 N30÷N38		€ 1.510,00	€ 1.660,00
TC**	TC**		€ 1.015,00	€ 1.165,00

\*\*TC = Minimum order 10 pcs each fabric colour. Feasibility to be approved  
TC = Ordine minimo 10 pz per colore/tessuto. Fattibilità da valutare

\*Excluding / Escluso H140+H143

For fabrics see page 367  
Per i tessuti si veda a p. 367

PACKING / Imballo



FABRIC REQUIRED / Fabbisogno tessuto  
1pc: Lin Mtrs 3,50 (h 1,40)

TECHNICAL DETAILS / Dettagli tecnici

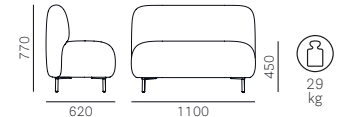

For colours and finishes see at page 362  
Per colori e finiture vedere da pagina 362

## Buddy 215S/TT

Turning tablet  
Tavoletta girevoleTOP  
Ripiano

**€ 180,00**  
For item  
Per articoli  
212, 212S, 213, 213S  
214, 214S, 215, 215S

## FINISHES / Finiture

Anti-fingerprint finish  
Finitura anti-impronta

FNP\_NE

## PACKING / Imballo

1 pc KD  
MC 0,031

## TECHNICAL DETAILS / Dettagli tecnici

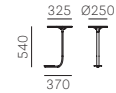

## Buddy 212S.3

Cushion only  
Solo cuscino

SEAT Sedile	BACK Schienale	FABRIC Tessuto
C	C	<b>€ 125,00</b>
D40÷D44	D40÷D44	<b>€ 146,00</b>
E	E	<b>€ 178,00</b>
G	G	<b>€ 178,00</b>
H*	H*	<b>€ 133,00</b>
N01÷N08 N30÷N38	N01÷N08 N30÷N38	<b>€ 193,00</b>
TC**	TC**	<b>€ 108,00</b>

\*\*TC = Minimum order 10 pcs each fabric colour. Feasibility to be approved  
TC = Ordine minimo 10 pz per colore/tessuto. Fattibilità da valutare

\*Excluding / Escluso H140+H143

For fabrics see page 367  
Per i tessuti si veda a p. 367

## PACKING / Imballo

2 pcs MC 0,1

**FABRIC REQUIRED / Fabbisogno tessuto**  
1pc: Lin Mtrs 0,50 (h 1,40)

## TECHNICAL DETAILS / Dettagli tecnici



## Buddyhub



CODE Codice	SEAT Sedile	BACK Schienale	PANEL Pannello	FRAME Telaio	BLACK POWDER COATED Verniciato nero
<b>BDH001/100</b> One seat low backrest Un posto schienale basso	D40÷D44	D40÷D44	D40÷D44	Ø 25	€ 3.050,00
	E	E	E		€ 3.414,00
	G	G	G		€ 3.414,00
	H*	H*	H*		€ 2.970,00
<b>BDH001/140</b> One seat high backrest Un posto schienale alto	D40÷D44	D40÷D44	D40÷D44	Ø 25	€ 3.230,00
	E	E	E		€ 3.684,00
	G	G	G		€ 3.684,00
	H*	H*	H*		€ 3.130,00
<b>BDH001/140_USB</b> One seat with USB socket Un posto con presa USB	D40÷D44	D40÷D44	D40÷D44	Ø 25	€ 3.500,00
	E	E	E		€ 3.954,00
	G	G	G		€ 3.954,00
	H*	H*	H*		€ 3.400,00
<b>BDH001T/140</b> One seat with turning tablet Un posto con tavoletta girevole	D40÷D44	D40÷D44	D40÷D44	Ø 25	€ 4.057,00
	E	E	E		€ 3.470,00
	G	G	G		€ 3.924,00
	H*	H*	H*		€ 3.924,00
<b>BDH001T/140_USB</b> One seat with turning tablet and USB socket Un posto con tavoletta girevole e presa USB	D40÷D44	D40÷D44	D40÷D44	Ø 25	€ 3.370,00
	E	E	E		€ 4.027,00
	G	G	G		€ 3.740,00
	H*	H*	H*		€ 4.194,00
<b>BDH002/100</b> Two-seater low backrest Due posti schienale basso	D40÷D44	D40÷D44	D40÷D44	Ø 25	€ 4.194,00
	E	E	E		€ 4.194,00
	G	G	G		€ 3.640,00
	H*	H*	H*		€ 3.640,00
<b>BDH002/140</b> Two-seater high backrest Due posti schienale alto	D40÷D44	D40÷D44	D40÷D44	Ø 25	€ 4.297,00
	E	E	E		€ 3.972,00
	G	G	G		€ 4.504,00
	H*	H*	H*		€ 4.504,00
<b>BDH002T/140</b> Two-seater with turning tablet and USB socket Un posto con tavoletta girevole e presa USB	D40÷D44	D40÷D44	D40÷D44	Ø 25	€ 3.858,00
	E	E	E		€ 4.618,00
	G	G	G		€ 4.138,00
	H*	H*	H*		€ 4.750,00
<b>BDH002T/140_USB</b> Two-seater with turning tablet and USB socket Un posto con tavoletta girevole e presa USB	D40÷D44	D40÷D44	D40÷D44	Ø 25	€ 4.750,00
	E	E	E		€ 4.750,00
	G	G	G		€ 4.002,00
	H*	H*	H*		€ 4.002,00
<b>BDH002T/140_USB</b> Two-seater with turning tablet and USB socket Un posto con tavoletta girevole e presa USB	D40÷D44	D40÷D44	D40÷D44	Ø 25	€ 4.887,00
	E	E	E		€ 4.887,00
	G	G	G		€ 4.887,00
	H*	H*	H*		€ 4.887,00

\*Excluding / Escluso H82+H89, H20+H35; H100+H108, H140+H143, N20+N27

For fabrics see page 367  
Per i tessuti si veda a p. 367SAFETY, STRENGTH and DURABILITY TESTS  
Prove di sicurezza, resistenza e durata  
EN 1728:2012+AC2013  
EN 16139:2013 level 2  
(for BDH001/140 - BDH002/140)

## TECHNICAL DETAILS / Dettagli tecnici

### BDH001/100

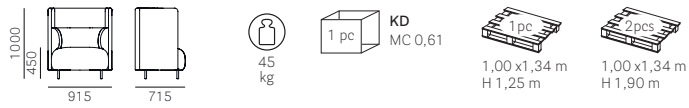

### BDH001/140



### BDH001/140\_USB

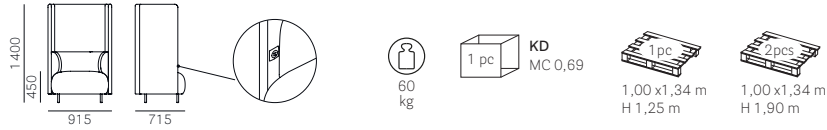

### BDH001T/140



### BDH001T/140\_USB

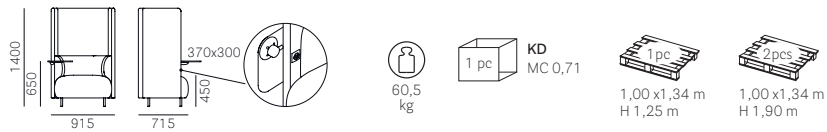

### BDH002/100

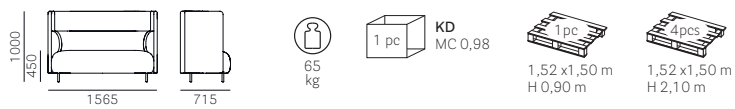

### BDH002/140

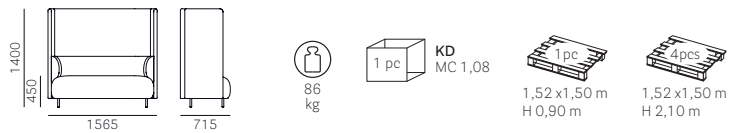

Do not stack pallets or other packaging  
Divieto di sovrapporre bancali o altri imballi

## TABLET FINISH / Finitura tavoletta

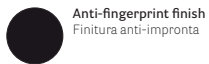

Anti-fingerprint finish  
Finitura anti-impronta

FNP\_NE

## Buddyhub

BOX



Possibility of adding sockets to connect a charger or install a screen holder  
Predisposizione all'elettificazione per collegare carica batterie o prevedere il fissaggio di un monitor

CODE Codice	SEAT Sedile	BACK Schienale	PANEL Pannello	FRAME Telaio	BLACK POWDER COATED Verniciato nero
<b>BDH011/140</b> Two-seater box Box a due posti	D40÷D44	D40÷D44	D40÷D44		€ 6.834,00
	E	E	E		€ 7.834,00
	G	G	G	Ø 25	€ 7.834,00
	H*	H*	H*		€ 6.614,00
<b>BDH011M/140</b> Two-seater box with shelf Box a due posti con mensola	D40÷D44	D40÷D44	D40÷D44		€ 8.050,00
	E	E	E		€ 7.008,00
	G	G	G	Ø 25	€ 8.010,00
	H*	H*	H*		€ 8.010,00
<b>BDH011P/140</b> Two-seater box with table Box a due posti con tavolo a penisola	D40÷D44	D40÷D44	D40÷D44		€ 6.788,00
	E	E	E		€ 8.226,00
	G	G	G	Ø 25	€ 7.158,00
	H*	H*	H*		€ 8.160,00
<b>BDH011P/140_CCO</b> Two-seater box with table and cable management Box a due posti con tavolo a penisola e canalina	D40÷D44	D40÷D44	D40÷D44		€ 8.938,00
	E	E	E		€ 8.376,00
	G	G	G	Ø 25	€ 7.248,00
	H*	H*	H*		€ 8.250,00
<b>BDH011P/140_CCO</b> Two-seater box with table and cable management Box a due posti con tavolo a penisola e canalina	D40÷D44	D40÷D44	D40÷D44		€ 8.250,00
	E	E	E		€ 7.028,00
	G	G	G	Ø 25	€ 8.466,00
	H*	H*	H*		€ 8.590,00
<b>BDH022/140</b> Four-seater box Box a quattro posti	D40÷D44	D40÷D44	D40÷D44		€ 9.906,00
	E	E	E		€ 9.906,00
	G	G	G	Ø 25	€ 9.906,00
	H*	H*	H*		€ 8.298,00
<b>BDH022M/140</b> Four-seater box with shelf Box a quattro posti con mensola	D40÷D44	D40÷D44	D40÷D44		€ 10.194,00
	E	E	E		€ 8.764,00
	G	G	G	Ø 25	€ 10.082,00
	H*	H*	H*		€ 10.082,00
<b>BDH022P/140</b> Four-seater box with table Box a quattro posti con tavolo a penisola	D40÷D44	D40÷D44	D40÷D44		€ 8.472,00
	E	E	E		€ 10.370,00
	G	G	G	Ø 25	€ 9.044,00
	H*	H*	H*		€ 10.362,00
<b>BDH022P/140</b> Four-seater box with table Box a quattro posti con tavolo a penisola	D40÷D44	D40÷D44	D40÷D44		€ 10.362,00
	E	E	E		€ 8.752,00
	G	G	G	Ø 25	€ 10.362,00
	H*	H*	H*		€ 8.752,00
<b>BDH022P/140_CCO</b> Four-seater box with table and cable management Box a quattro posti con tavolo a penisola e canalina	D40÷D44	D40÷D44	D40÷D44		€ 10.650,00
	E	E	E		€ 9.134,00
	G	G	G	Ø 25	€ 10.452,00
	H*	H*	H*		€ 10.452,00
<b>BDH022P/140_CCO</b> Four-seater box with table and cable management Box a quattro posti con tavolo a penisola e canalina	D40÷D44	D40÷D44	D40÷D44		€ 8.842,00
	E	E	E		€ 8.842,00
	G	G	G	Ø 25	€ 8.842,00
	H*	H*	H*		€ 10.740,00
<b>BDH022P/140_CCO</b> Four-seater box with table and cable management Box a quattro posti con tavolo a penisola e canalina	D40÷D44	D40÷D44	D40÷D44		€ 10.740,00
	E	E	E		
	G	G	G	Ø 25	
	H*	H*	H*		

\*Excluding / Escluso H82+H89, H20+H35; H100+H108, H140+H143, N20+N27

For fabrics see page 367  
Per i tessuti si veda a p. 367

## TECHNICAL DETAILS / Dettagli tecnici

### BDH011/140

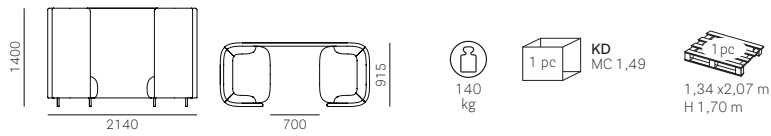

### BDH011M/140

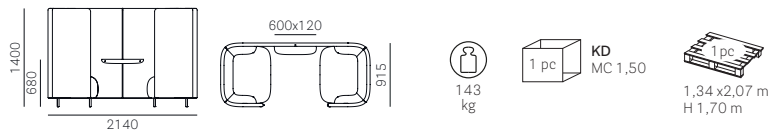

### BDH011P/140

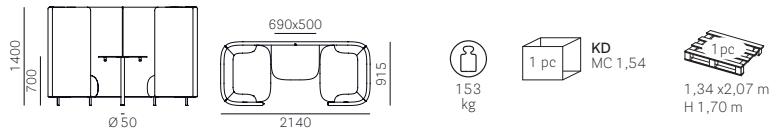

### BDH011P/140\_CCO

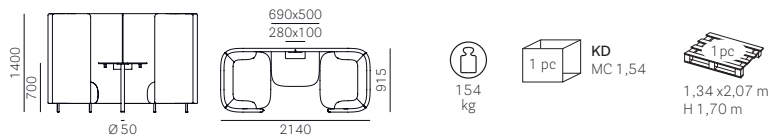

### BDH022/140

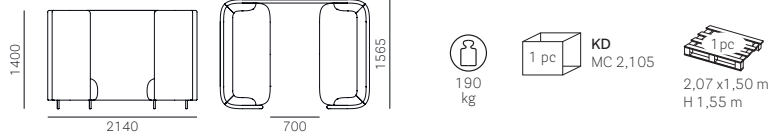

### BDH022M/140

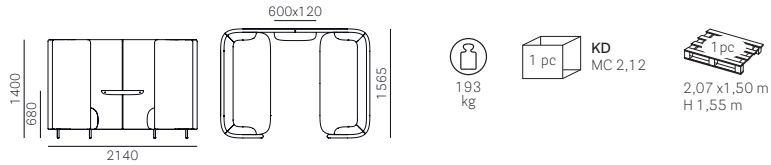

### BDH022P/140

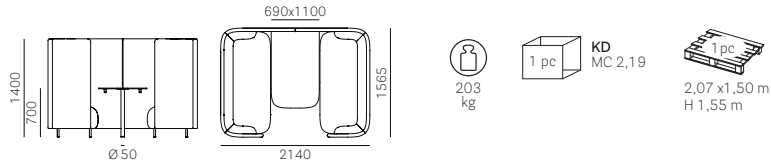

### BDH022P/140\_CCO

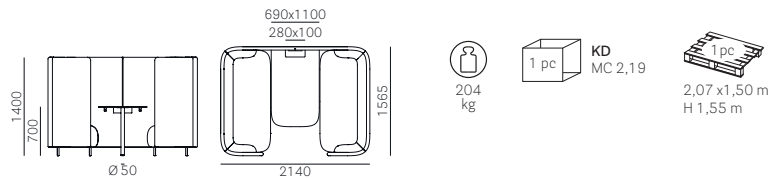

Do not stack pallets or other packaging  
Divieto di sovrapporre bancali o altri imballi

**STEEL SHELF FINISH**  
Finitura mensola in lamiera



NERO

**TABLE TOP FINISH**  
Finitura ripiano tavolo a penisola



FNP\_NE

**Anti-fingerprint finish**  
Finitura anti-impronta



# Buddy Sofa

Fabric version  
Versione in tessuto

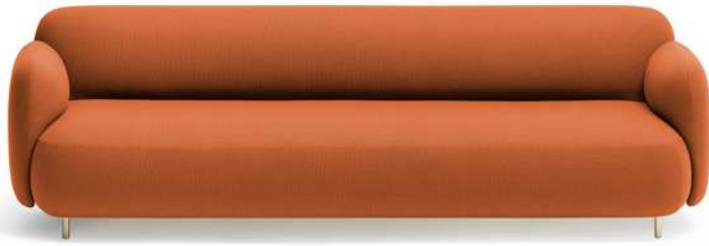

CODE Codice	SEAT Sedile	BACK Schienale	FRAME Telaio	POWDER COATED Verniciato	ANTIQUÉ BRASS Ottone anticato
<b>With armrests / Con braccioli</b>					
<b>218</b> Two seater sofa Divano a due posti	E	E	Ø 25	€ 3.350,00	€ 3.350,00
	G	G		€ 3.142,00	€ 3.142,00
	H40+H53 H120+H127 H140+H143 H60	H40+H53 H120+H127 H140+H143 H60		€ 2.692,00	€ 2.692,00
	N01+N08 N30+N38	N01+N08 N30+N38		€ 3.304,00	€ 3.304,00
<b>219</b> Three seater sofa Divano a tre posti	E	E	Ø 25	€ 3.962,00	€ 3.962,00
	G	G		€ 3.720,00	€ 3.720,00
	H40+H53 H120+H127 H140+H143 H60	H40+H53 H120+H127 H140+H143 H60		€ 3.223,00	€ 3.223,00
	N01+N08 N30+N38	N01+N08 N30+N38		€ 3.893,00	€ 3.893,00
<b>Without armrests / Senza braccioli</b>					
<b>218/2</b> Two seater sofa Divano a due posti	E	E	Ø 25	€ 2.449,00	€ 2.449,00
	G	G		€ 2.310,00	€ 2.310,00
	H40+H53 H120+H127 H140+H143 H60	H40+H53 H120+H127 H140+H143 H60		€ 1.987,00	€ 1.987,00
	N01+N08 N30+N38	N01+N08 N30+N38		€ 2.426,00	€ 2.426,00
<b>219/2</b> Three seater sofa Divano a tre posti	E	E	Ø 25	€ 3.061,00	€ 3.061,00
	G	G		€ 2.888,00	€ 2.888,00
	H40+H53 H120+H127 H140+H143 H60	H40+H53 H120+H127 H140+H143 H60		€ 2.518,00	€ 2.518,00
	N01+N08 N30+N38	N01+N08 N30+N38		€ 3.015,00	€ 3.015,00

**SAFETY, STRENGTH and DURABILITY TESTS**

Prove di sicurezza, resistenza e durata

EN 1728:2012+AC2013

EN 16139:2013 level 2

**TECHNICAL DETAILS / Dettagli tecnici**

**218**

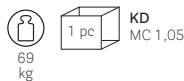

**219**

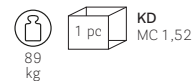
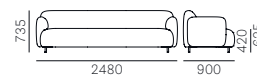

**218/2**

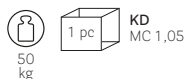

**219/2**

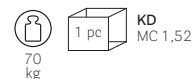
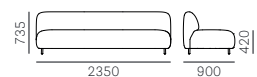

# Buddy Sofa

Leather version  
Versione in pelle



Stitching for simil leather and leather version  
Cuciture versione in finta e vera pelle

CODE Codice	SEAT Sedile	BACK Schienale	FRAME Telaio	POWDER COATED Verniciato	ANTIQUÉ BRASS Ottone anticato
<b>With armrests / Con braccioli</b>					
<b>218</b> Two seater sofa Divano a due posti	C130+C141	C130+C141	Ø 25	<b>€ 2.738,00</b>	<b>€ 2.738,00</b>
	H20+H35; H100+H108	H20+H35; H100+H108		<b>€ 2.807,00</b>	<b>€ 2.807,00</b>
	P*	P*		<b>€ 3.800,00</b>	<b>€ 3.800,00</b>
<b>219</b> Three seater sofa Divano a tre posti	C130+C141	C130+C141	Ø 25	<b>€ 3.246,00</b>	<b>€ 3.246,00</b>
	H20+H35; H100+H108	H20+H35; H100+H108		<b>€ 3.338,00</b>	<b>€ 3.338,00</b>
	P*	P*		<b>€ 4.620,00</b>	<b>€ 4.620,00</b>
<b>Without armrests / Senza braccioli</b>					
<b>218/2</b> Two seater sofa Divano a due posti	C130+C141	C130+C141	Ø 25	<b>€ 2.056,00</b>	<b>€ 2.056,00</b>
	H20+H35; H100+H108	H20+H35; H100+H108		<b>€ 2.103,00</b>	<b>€ 2.103,00</b>
	P*	P*		<b>€ 2.796,00</b>	<b>€ 2.796,00</b>
<b>219/2</b> Three seater sofa Divano a tre posti	C130+C141	C130+C141	Ø 25	<b>€ 2.565,00</b>	<b>€ 2.565,00</b>
	H20+H35; H100+H108	H20+H35; H100+H108		<b>€ 2.634,00</b>	<b>€ 2.634,00</b>
	P*	P*		<b>€ 3.616,00</b>	<b>€ 3.616,00</b>

\*Excluding / Escluso PBS-PCO-PMS-PVE

## SAFETY, STRENGTH and DURABILITY TESTS

Prove di sicurezza, resistenza e durata

EN 1728:2012+AC2013

EN 16139:2013 level 2

## TECHNICAL DETAILS / Dettagli tecnici

**218**

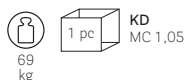
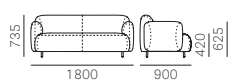

For fabrics see page 367  
Per i tessuti si veda a p. 367

For colours and finishes see at page 362  
Per colori e finiture vedere da pagina 362

**219**

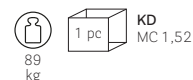
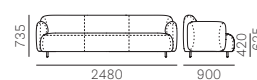

**218/2**

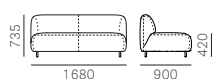

**219/2**

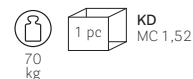
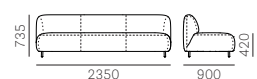

## Cube 1400



SEAT Sedile	FRAME Telaio	WHITE/BLACK POWDER COATED Verniciato bianco/nero
Frame only / Solo telaio		€ 89,00
A95, A96	25x25	€ 144,00
PNE, PBI		€ 209,00

### FINISHES / Finiture



### PACKING / Imballo



### TECHNICAL DETAILS / Dettagli tecnici



## Cube 1401



SEAT Sedile	FRAME Telaio	CHROMED Cromato	SATINIZED Satinato	CORTEN Effetto Corten	ANTIQU BRASS/COPPER Ottone/rame anticato
Frame only / Solo telaio		€ 102,00	€ 130,00	€ 130,00	€ 169,00
A	25x25	€ 157,00	€ 185,00	€ 185,00	€ 224,00
C*		€ 174,00	€ 202,00	€ 202,00	€ 241,00
G		€ 208,00	€ 236,00	€ 236,00	€ 275,00
H*		€ 173,00	€ 201,00	€ 201,00	€ 240,00
P*		€ 222,00	€ 250,00	€ 250,00	€ 289,00
TC**		€ 157,00	€ 185,00	€ 185,00	€ 224,00
CL**		€ 164,00	€ 192,00	€ 192,00	€ 231,00
PG		€ 124,00	€ 152,00	€ 152,00	€ 191,00

\*\*TC/CL = Minimum order 10 pcs each fabric colour  
TC/CL = Ordine minimo 10 pz per colore/tessuto

\*Excluding / Escluso C36+C39, H140+H143, PBS-PCO-PMS-PVE

For fabrics see page 367  
Per i tessuti si veda a p. 367

### PACKING / Imballo



FABRIC REQUIRED / Fabbisogno tessuto  
1pc: Lin Mtrs 0,40 (h 1,40)

### TECHNICAL DETAILS / Dettagli tecnici



## Cube 1401/RV



SEAT Sedile	FRAME Telaio	CHROMED Cromato	SATINIZED Satinato
Frame only / Solo telaio		€ 102,00	€ 130,00
RS-W	25x25	€ 142,00	€ 170,00

### FINISHES / Finiture



### PACKING / Imballo



### TECHNICAL DETAILS / Dettagli tecnici



## Cube 1402



SEAT Sedile	FRAME Telaio	WHITE/BLACK POWDER COATED Verniciato bianco/nero
Frame only / Solo telaio		€ 74,00
A95, A96	25x25	€ 129,00
PNE, PBI		€ 194,00

### FINISHES / Finiture



### PACKING / Imballo



### TECHNICAL DETAILS / Dettagli tecnici



## Cube 1402



SEAT Sedile	FRAME Telaio	CHROMED Cromato	SATINIZED Satinato	CORTEN Effetto Corten	ANTIQU BRASS/COPPER Ottone/rame anticato
Frame only / Solo telaio		€ 99,00	€ 129,00	€ 129,00	€ 166,00
A	25x25	€ 154,00	€ 184,00	€ 184,00	€ 221,00
C*		€ 171,00	€ 201,00	€ 201,00	€ 238,00
G		€ 205,00	€ 235,00	€ 235,00	€ 272,00
H*		€ 170,00	€ 200,00	€ 200,00	€ 237,00
P*		€ 219,00	€ 249,00	€ 249,00	€ 286,00
TC**		€ 154,00	€ 184,00	€ 184,00	€ 221,00
CL**		€ 161,00	€ 191,00	€ 191,00	€ 228,00
PG		€ 121,00	€ 151,00	€ 151,00	€ 188,00

\*\*TC/CL = Minimum order 10 pcs each fabric colour  
TC/CL = Ordine minimo 10 pz per colore/tessuto

\*Excluding / Escluso C36+C39, H140+H143, PBS-PCO-PMS-PVE

For fabrics see page 367  
Per i tessuti si veda a p. 367

### PACKING / Imballo



### TECHNICAL DETAILS / Dettagli tecnici



**FABRIC REQUIRED / Fabbisogno tessuto**  
1pc: Lin Mtrs 0,40 (h 1,40)

## Cube 1402/RV



SEAT Sedile	FRAME Telaio	CHROMED Cromato	SATINIZED Satinato
RS-W	25x25	€ 139,00	€ 163,00

### FINISHES / Finiture



### PACKING / Imballo

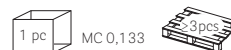

### TECHNICAL DETAILS / Dettagli tecnici



## Cube 1403



SEAT Sedile	FRAME Telaio	WHITE/BLACK POWDER COATED Verniciato bianco/nero
Frame only / Solo telaio		€ 71,00
A95, A96	25x25	€ 126,00
PNE, PBI		€ 191,00

### FINISHES / Finiture



### PACKING / Imballo



### TECHNICAL DETAILS / Dettagli tecnici



## Cube 1403



SEAT Sedile	FRAME Telaio	CHROMED Cromato	SATINIZED Satinato	CORTEN Effetto Corten	ANTIQU BRASS/COPPER Ottone/rame anticato
Frame only / Solo telaio		€ 97,00	€ 126,00	€ 126,00	€ 163,00
A	25x25	€ 152,00	€ 181,00	€ 181,00	€ 218,00
C*		€ 169,00	€ 198,00	€ 198,00	€ 235,00
G		€ 203,00	€ 232,00	€ 232,00	€ 269,00
H*		€ 168,00	€ 197,00	€ 197,00	€ 234,00
P*		€ 217,00	€ 246,00	€ 246,00	€ 283,00
TC**		€ 152,00	€ 181,00	€ 181,00	€ 218,00
CL**		€ 159,00	€ 188,00	€ 188,00	€ 225,00
PG		€ 119,00	€ 148,00	€ 148,00	€ 185,00

\*\*TC/CL = Minimum order 10 pcs each fabric colour  
TC/CL = Ordine minimo 10 pz per colore/tessuto

\*Excluding / Escluso C36+C39, H140+H143, PBS-PCO-PMS-PVE

For fabrics see page 367  
Per i tessuti si veda a p. 367

### PACKING / Imballo



FABRIC REQUIRED / Fabbisogno tessuto  
1pc: Lin Mtrs 0,40 (h 1,40)

### TECHNICAL DETAILS / Dettagli tecnici



## Cube 1403/RV



SEAT Sedile	FRAME Telaio	CHROMED Cromato	SATINIZED Satinato
RS-W	25x25	€ 137,00	€ 159,00

### FINISHES / Finiture



### PACKING / Imballo

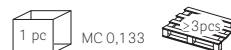

### TECHNICAL DETAILS / Dettagli tecnici



## Cube XL 1451



SEAT Sedile	FRAME Telaio	CHROMED Cromato	SATINIZED Satinato
Frame only / Solo telaio		€ 101,00	€ 153,00
A	25x25	€ 170,00	€ 222,00
C*		€ 186,00	€ 238,00
G		€ 230,00	€ 282,00
H*		€ 189,00	€ 241,00
P*		€ 241,00	€ 293,00
TC**		€ 170,00	€ 222,00
CL**		€ 176,00	€ 228,00
PG		€ 144,00	€ 196,00

\*\*TC/CL = Minimum order 10 pcs each fabric colour  
TC/CL = Ordine minimo 10 pz per colore/tessuto

\*Excluding / Escluso C36+C39, H140+H143, PBS-PCO-PMS-PVE

For fabrics see page 367  
Per i tessuti si veda a p. 367

PACKING / Imballo



FABRIC REQUIRED / Fabbisogno tessuto  
1pc: Lin Mtrs 0,50 (h 1,40)

TECHNICAL DETAILS / Dettagli tecnici

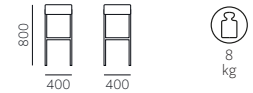

## Cube XL 1453



SEAT Sedile	FRAME Telaio	CHROMED Cromato	SATINIZED Satinato
Frame only / Solo telaio		€ 98,00	€ 150,00
A	25x25	€ 167,00	€ 219,00
C*		€ 183,00	€ 235,00
G		€ 227,00	€ 279,00
H*		€ 186,00	€ 238,00
P*		€ 238,00	€ 290,00
TC**		€ 167,00	€ 219,00
CL**		€ 173,00	€ 225,00
PG		€ 141,00	€ 193,00

\*\*TC/CL = Minimum order 10 pcs each fabric colour  
TC/CL = Ordine minimo 10 pz per colore/tessuto

\*Excluding / Escluso C36+C39, H140+H143, PBS-PCO-PMS-PVE

For fabrics see page 367  
Per i tessuti si veda a p. 367

PACKING / Imballo



FABRIC REQUIRED / Fabbisogno tessuto  
1pc: Lin Mtrs 0,50 (h 1,40)

TECHNICAL DETAILS / Dettagli tecnici



## Cube XL 1461



SEAT Sedile	BACK Schienale	FRAME Telaio	BLACK POWDER COATED Verniciato nero	POWDER COATED Verniciato	CHROMED Cromato	SATINIZED Satinato
A	A	25x25	€ 268,00	€ 274,00	€ 315,00	€ 350,00
C*	C*		€ 295,00	€ 301,00	€ 343,00	€ 378,00
G	G		€ 372,00	€ 379,00	€ 420,00	€ 455,00
H*	H*		€ 300,00	€ 306,00	€ 348,00	€ 383,00
P*	P*		€ 399,00	€ 406,00	€ 447,00	€ 482,00
TC**	TC**		€ 268,00	€ 274,00	€ 315,00	€ 350,00
CL**	CL**		€ 274,00	€ 280,00	€ 321,00	€ 356,00
PG	PG		€ 185,00	€ 191,00	€ 233,00	€ 268,00

\*\*TC/CL = Minimum order 10 pcs each fabric colour  
TC/CL = Ordine minimo 10 pz per colore/tessuto

\*Excluding / Escluso C36+C39, H140+H143, PBS-PCO-PMS-PVE

For fabrics see page 367  
Per i tessuti si veda a p. 367

PACKING / Imballo

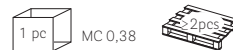

FABRIC REQUIRED / Fabbisogno tessuto  
1pc: Lin Mtrs 1,00 (h 1,40)

TECHNICAL DETAILS / Dettagli tecnici

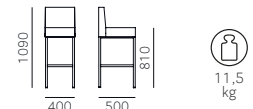

For colours and finishes see at page 362  
Per colori e finiture vedere da pagina 362

## Day Dream 401



SEAT Sedile	BACK Schienale	FRAME Telaio	WHITE POWDER COATED Verniciato bianco	BLACK POWDER COATED Verniciato nero	CHROMED Cromato
PC	PC	Ø 11	€ 106,00*	€ 106,00*	€ 112,00

FRAME/TELAIO\*  
Powder coated in the same colour of the shell / Verniciato in tinta con la scocca

PC FINISHES / Finiture PC

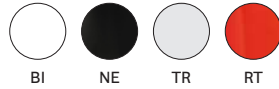

PACKING / Imballo



TECHNICAL DETAILS / Dettagli tecnici

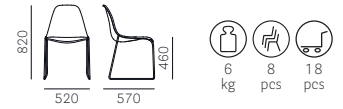

SAFETY, STRENGTH and DURABILITY TESTS  
Prove di sicurezza, resistenza e durata  
EN 1728:2000

## Day Dream 401/CL1

Fire retardant version  
Versione ignifuga



SEAT Sedile	BACK Schienale	FRAME Telaio	WHITE POWDER COATED Verniciato bianco	CHROMED Cromato
PC	PC	Ø 11	€ 122,00*	€ 129,00

Minimum order 300 pcs each colour  
Ordine minimo 300 pz per colore

FRAME/TELAIO\*  
Powder coated in the same colour of the shell / Verniciato in tinta con la scocca

PC FINISHES / Finiture PC

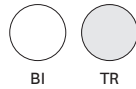

PACKING / Imballo



TECHNICAL DETAILS / Dettagli tecnici

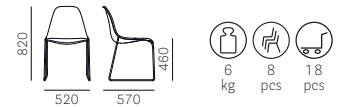

SAFETY, STRENGTH and DURABILITY TESTS  
Prove di sicurezza, resistenza e durata  
EN 1728:2000

## Day Dream 405



SEAT Sedile	BACK Schienale	FRAME Telaio	WHITE POWDER COATED Verniciato bianco	BLACK POWDER COATED Verniciato nero	SILVER POWDER COATED Verniciato alluminio	CHROMED Cromato	MATT CHROMED Cromato opaco
PC	PC	Ø 16	€ 126,00*	€ 126,00*	€ 143,00	€ 126,00	€ 139,00

FRAME/TELAIO\*  
Powder coated in the same colour of the shell / Verniciato in tinta con la scocca

PC FINISHES / Finiture PC

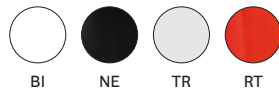

PACKING / Imballo



TECHNICAL DETAILS / Dettagli tecnici

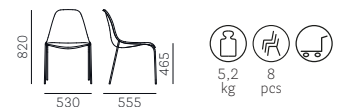

SAFETY, STRENGTH and DURABILITY TESTS  
Prove di sicurezza, resistenza e durata  
EN 1728:2000

## Dome 260



SEAT Sedile	BACK Schienale	FRAME Telaio	POLYPROPYLENE Polipropilene
PPL	PPL	PPL	€ 60,00

**SAFETY, STRENGTH and DURABILITY TESTS**  
 Prove di sicurezza, resistenza e durata  
 EN 1728:2012+AC2013  
 EN 16139:2013 level 2

PPL FINISHES / Finiture PPL

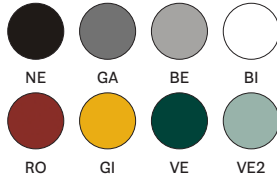

PACKING / Imballo



TECHNICAL DETAILS / Dettagli tecnici

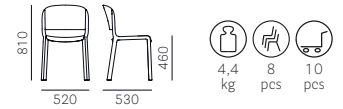

## Dome 260/CL1

Fire retardant version  
 Versione ignifuga



SEAT Sedile	BACK Schienale	FRAME Telaio	POLYPROPYLENE Polipropilene
PPL	PPL	PPL	€ 93,00

Minimum order 300 pcs  
 Ordine minimo 300 pz

PPL FINISHES / Finiture PPL



PACKING / Imballo



TECHNICAL DETAILS / Dettagli tecnici

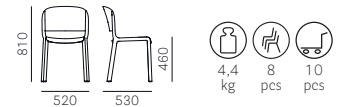

**SAFETY, STRENGTH and DURABILITY TESTS**  
 Prove di sicurezza, resistenza e durata  
 EN 1728:2012+AC2013  
 EN 16139:2013 level 2

## Dome 261

Perforated  
 Forata



SEAT Sedile	BACK Schienale	FRAME Telaio	POLYPROPYLENE Polipropilene
PPL	PPL	PPL	€ 60,00

PPL FINISHES / Finiture PPL

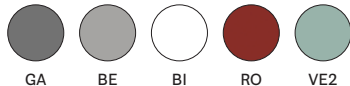

PACKING / Imballo



TECHNICAL DETAILS / Dettagli tecnici

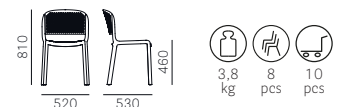



## Dome 265



SEAT Sedile	BACK Schienale	FRAME Telaio
PPL	PPL	PPL

POLYPROPYLENE  
Polipropilene

€ 71,00

PPL FINISHES / Finiture PPL



**SAFETY, STRENGTH and DURABILITY TESTS**  
Prove di sicurezza, resistenza e durata  
EN 1728:2012+AC2013  
EN 16139:2013 level 2

PACKING / Imballo



TECHNICAL DETAILS / Dettagli tecnici

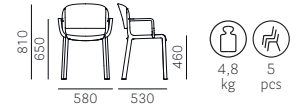

## Dome 265/CL1

Fire retardant version  
Versione ignifuga



SEAT Sedile	BACK Schienale	FRAME Telaio
PPL	PPL	PPL

POLYPROPYLENE  
Polipropilene

€ 107,00

Minimum order 300 pcs  
Ordine minimo 300 pz

PPL FINISHES / Finiture PPL



**SAFETY, STRENGTH and DURABILITY TESTS**  
Prove di sicurezza, resistenza e durata  
EN 1728:2012+AC2013  
EN 16139:2013 level 2

PACKING / Imballo



TECHNICAL DETAILS / Dettagli tecnici

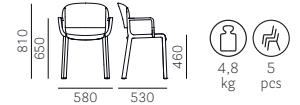

## Dome 266

Perforated  
Forata



SEAT Sedile	BACK Schienale	FRAME Telaio
PPL	PPL	PPL

POLYPROPYLENE  
Polipropilene

€ 71,00

PPL FINISHES / Finiture PPL

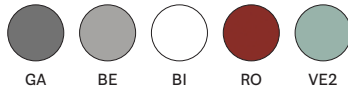

PACKING / Imballo



TECHNICAL DETAILS / Dettagli tecnici

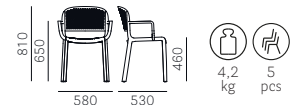

## Dome 267



**SAFETY, STRENGTH and DURABILITY TESTS**  
 Prove di sicurezza, resistenza e durata  
 EN 1728:2012+AC2013  
 EN 16139:2013 level 2

SEAT Sedile	FRAME Telaio	POLYPROPYLENE Polipropilene
PPL	PPL H650	<b>€ 79,00</b>

PPL FINISHES / Finiture PPL

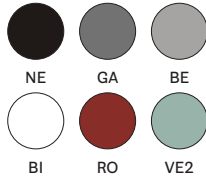

PACKING / Imballo



TECHNICAL DETAILS / Dettagli tecnici



## Dome 268



**SAFETY, STRENGTH and DURABILITY TESTS**  
 Prove di sicurezza, resistenza e durata  
 EN 1728:2012+AC2013  
 EN 16139:2013 level 2

SEAT Sedile	FRAME Telaio	POLYPROPYLENE Polipropilene
PPL	PPL H760	<b>€ 80,00</b>

PPL FINISHES / Finiture PPL

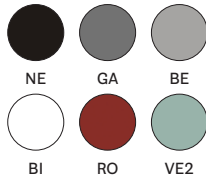

PACKING / Imballo



TECHNICAL DETAILS / Dettagli tecnici

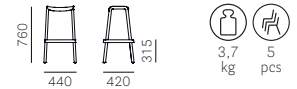

## Dream 4833F



S350CON

SEAT Sedile	FRAME Telaio	BLACK POWDER COATED Verniciato nero	POWDER COATED Verniciato	CHROMED Cromato	SATINIZED Satinato
Frame only / Solo telaio		<b>€ 88,00</b>	<b>€ 93,00</b>	<b>€ 131,00</b>	<b>€ 147,00</b>
A	Ø 400	<b>€ 149,00</b>	<b>€ 154,00</b>	<b>€ 192,00</b>	<b>€ 208,00</b>
C*		<b>€ 165,00</b>	<b>€ 170,00</b>	<b>€ 208,00</b>	<b>€ 224,00</b>
G		<b>€ 213,00</b>	<b>€ 218,00</b>	<b>€ 256,00</b>	<b>€ 272,00</b>
H*		<b>€ 169,00</b>	<b>€ 174,00</b>	<b>€ 212,00</b>	<b>€ 228,00</b>
P*		<b>€ 229,00</b>	<b>€ 234,00</b>	<b>€ 272,00</b>	<b>€ 288,00</b>
TC**		<b>€ 149,00</b>	<b>€ 154,00</b>	<b>€ 192,00</b>	<b>€ 208,00</b>
CL**		<b>€ 154,00</b>	<b>€ 159,00</b>	<b>€ 197,00</b>	<b>€ 213,00</b>
PG		<b>€ 112,00</b>	<b>€ 117,00</b>	<b>€ 155,00</b>	<b>€ 171,00</b>

\*\*TC/CL = Minimum order 10 pcs each fabric colour

TC/CL = Ordine minimo 10 pz per colore/tessuto

\*Excluding / Escluso C36+C39, H140+H143, PBS-PCO-PMS-PVE

For fabrics see page 367  
 Per i tessuti si veda a p. 367

PACKING / Imballo



FABRIC REQUIRED / Fabbisogno tessuto  
 1 pc: Lin Mtrs 0,60 (h 1,40)

TECHNICAL DETAILS / Dettagli tecnici

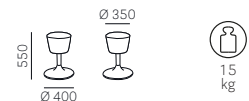

For colours and finishes see at page 362  
 Per colori e finiture vedere da pagina 362

## Dream 4833G



S350CON

SEAT Sedile	FRAME Telaio	BLACK POWDER COATED Verniciato nero	POWDER COATED Verniciato	CHROMED Cromato	SATINIZED Satinato
Frame only / Solo telaio		€ 119,00	€ 124,00	€ 162,00	€ 178,00
A		€ 180,00	€ 185,00	€ 223,00	€ 239,00
C*		€ 196,00	€ 201,00	€ 239,00	€ 255,00
G		€ 244,00	€ 249,00	€ 287,00	€ 303,00
H*	Ø 400	€ 200,00	€ 205,00	€ 243,00	€ 259,00
P*		€ 260,00	€ 265,00	€ 303,00	€ 319,00
TC**		€ 180,00	€ 185,00	€ 223,00	€ 239,00
CL**		€ 185,00	€ 190,00	€ 228,00	€ 244,00
PG		€ 143,00	€ 148,00	€ 186,00	€ 202,00

\*\*TC/CL = Minimum order 10 pcs each fabric colour  
TC/CL = Ordine minimo 10 pz per colore/tessuto

\*Excluding / Escluso C36+C39, H140+H143, PBS-PCO-PMS-PVE

For fabrics see page 367  
Per i tessuti si veda a p. 367

PACKING / Imballo



FABRIC REQUIRED / Fabbisogno tessuto

1 pc: Lin Mtrs 0,60 (h 1,40)

TECHNICAL DETAILS / Dettagli tecnici



## Dream 4836



S350CON

SEAT Sedile	FRAME Telaio	BLACK POWDER COATED *** Verniciato nero	POWDER COATED *** Verniciato	CHROMED Cromato	SATINIZED Satinato
Frame only / Solo telaio		€ 139,00	€ 145,00	€ 200,00	€ 198,00
A		€ 200,00	€ 206,00	€ 261,00	€ 259,00
C*		€ 216,00	€ 222,00	€ 277,00	€ 275,00
G		€ 264,00	€ 270,00	€ 325,00	€ 323,00
H*	Ø 400	€ 220,00	€ 226,00	€ 281,00	€ 279,00
P*		€ 280,00	€ 286,00	€ 341,00	€ 339,00
TC**		€ 200,00	€ 206,00	€ 261,00	€ 259,00
CL**		€ 205,00	€ 211,00	€ 266,00	€ 264,00
PG		€ 163,00	€ 169,00	€ 224,00	€ 222,00

\*\*TC/CL = Minimum order 10 pcs each fabric colour  
TC/CL = Ordine minimo 10 pz per colore/tessuto

\*Excluding / Escluso C36+C39, H140+H143, PBS-PCO-PMS-PVE

\*\*\*For barstool with frame in powder coated finish, the footrest always comes in satin finish  
In caso di sgabello in finitura verniciata, il poggiatesta è sempre satinato

For fabrics see page 367  
Per i tessuti si veda a p. 367

PACKING / Imballo



FABRIC REQUIRED / Fabbisogno tessuto

1 pc: Lin Mtrs 0,60 (h 1,40)

TECHNICAL DETAILS / Dettagli tecnici

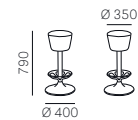

## Dream 4837



S350CON

SEAT Sedile	FRAME Telaio	BLACK POWDER COATED *** Verniciato nero	POWDER COATED *** Verniciato	CHROMED Cromato	SATINIZED Satinato
Frame only / Solo telaio		€ 170,00	€ 175,00	€ 230,00	€ 229,00
A		€ 231,00	€ 236,00	€ 291,00	€ 290,00
C*		€ 247,00	€ 252,00	€ 307,00	€ 306,00
G		€ 295,00	€ 300,00	€ 355,00	€ 354,00
H*	Ø 400	€ 251,00	€ 256,00	€ 311,00	€ 310,00
P*		€ 311,00	€ 316,00	€ 371,00	€ 370,00
TC**		€ 231,00	€ 236,00	€ 291,00	€ 290,00
CL**		€ 236,00	€ 241,00	€ 296,00	€ 295,00
PG		€ 194,00	€ 199,00	€ 254,00	€ 253,00

\*\*TC/CL = Minimum order 10 pcs each fabric colour  
TC/CL = Ordine minimo 10 pz per colore/tessuto

\*Excluding / Escluso C36+C39, H140+H143, PBS-PCO-PMS-PVE

\*\*\*For barstool with frame in powder coated finish, the footrest always comes in satin finish  
In caso di sgabello in finitura verniciata, il poggiatesta è sempre satinato

For fabrics see page 367  
Per i tessuti si veda a p. 367

PACKING / Imballo



FABRIC REQUIRED / Fabbisogno tessuto

1 pc: Lin Mtrs 0,60 (h 1,40)

TECHNICAL DETAILS / Dettagli tecnici



For colours and finishes see at page 362  
Per colori e finiture vedere da pagina 362

## Dream 4813



SEAT Sedile	FRAME Telaio	CHROMED Cromato	SATINIZED Satinato
Frame only / Solo telaio		€ 199,00	€ 210,00
A		€ 213,00	€ 224,00
C*		€ 218,00	€ 229,00
G		€ 231,00	€ 242,00
H*	Ø 400	€ 219,00	€ 230,00
P*		€ 236,00	€ 247,00
TC**		€ 213,00	€ 224,00
CL**		€ 219,00	€ 230,00
PG		€ 208,00	€ 219,00

\*\*TC/CL = Minimum order 10 pcs each fabric colour  
TC/CL = Ordine minimo 10 pz per colore/tessuto

\*Excluding / Escluso C36+C39, H140+H143, PBS-PCO-PMS-PVE

For fabrics see page 367  
Per i tessuti si veda a p. 367

PACKING / Imballo



FABRIC REQUIRED / Fabbisogno tessuto  
1pc: Lin Mtrs 0,17 (h 1,40)

TECHNICAL DETAILS / Dettagli tecnici



## Dream 4816



SEAT Sedile	FRAME Telaio	CHROMED Cromato	SATINIZED Satinato
Frame only / Solo telaio		€ 292,00	€ 299,00
A		€ 306,00	€ 313,00
C*		€ 311,00	€ 318,00
G		€ 324,00	€ 331,00
H*	Ø 400	€ 312,00	€ 319,00
P*		€ 329,00	€ 336,00
TC**		€ 306,00	€ 313,00
CL**		€ 312,00	€ 319,00
PG		€ 301,00	€ 308,00

\*\*TC/CL = Minimum order 10 pcs each fabric colour  
TC/CL = Ordine minimo 10 pz per colore/tessuto

\*Excluding / Escluso C36+C39, H140+H143, PBS-PCO-PMS-PVE

For fabrics see page 367  
Per i tessuti si veda a p. 367

PACKING / Imballo



FABRIC REQUIRED / Fabbisogno tessuto  
1pc: Lin Mtrs 0,17 (h 1,40)

TECHNICAL DETAILS / Dettagli tecnici

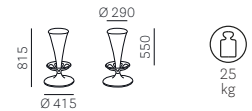

## Dress 530



SEAT Sedile	BACK Schienale	FRAME Telaio	OAK Rovere	OAK STAINED ON SAMPLE Rovere tinto campione
A	A		€ 303,00	€ 327,00
C*	C*		€ 323,00	€ 348,00
E	E		€ 443,00	€ 467,00
G	G	RS-W-N1- GC-BI	€ 443,00	€ 467,00
H*	H*		€ 335,00	€ 359,00
P*	P*	TC	€ 480,00	€ 504,00
TC**	TC**		€ 303,00	€ 327,00
CL**	CL**		€ 309,00	€ 333,00

\*\*TC/CL = Minimum order 10 pcs each fabric colour  
TC/CL = Ordine minimo 10 pz per colore/tessuto

\*Excluding / Escluso C36+C39, H140+H143, PBS-PCO-PMS-PVE

FINISHES / Finiture



RS W N1 GC BI

For fabrics see page 367  
Per i tessuti si veda a p. 367

PACKING / Imballo



FABRIC REQUIRED / Fabbisogno tessuto  
1pc: Lin Mtrs 1,10 (h 1,40)

TECHNICAL DETAILS / Dettagli tecnici



SAFETY, STRENGTH and DURABILITY TESTS  
Prove di sicurezza, resistenza e durata  
EN 1728:2000

## Dress 531

High back  
Schienale alto



SEAT Sedile	BACK Schienale	FRAME Telaio
A	A	
C*	C*	
E	E	RS-W-N1- GC-BI
G	G	
H*	H*	TC
P*	P*	
TC**	TC**	
CL**	CL**	

\*\*TC/CL = Minimum order 10 pcs each fabric colour  
TC/CL = Ordine minimo 10 pz per colore/tessuto

\*Excluding / Escluso C36+C39, H140+H143, PBS-PCO-PMS-PVE

### FINISHES / Finiture



**SAFETY, STRENGTH and DURABILITY TESTS**  
Prove di sicurezza, resistenza e durata  
EN 1728:2000

OAK  
Rovere

€ 312,00  
€ 340,00  
€ 470,00  
€ 470,00  
€ 353,00  
€ 490,00  
€ 312,00  
€ 318,00

OAK STAINED ON SAMPLE  
Rovere tinto campione

€ 336,00  
€ 365,00  
€ 494,00  
€ 494,00  
€ 377,00  
€ 514,00  
€ 336,00  
€ 342,00

Minimum order q.ty: 20 pcs  
Ordine minimo: 20pz

For fabrics see page 367  
Per i tessuti si veda a p. 367

### PACKING / Imballo



**FABRIC REQUIRED / Fabbisogno tessuto**  
1pc: Lin Mtrs 1,30 (h 1,40)

### TECHNICAL DETAILS / Dettagli tecnici

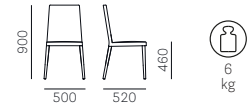

## Dress 533

High back  
Schienale alto



SEAT Sedile	BACK Schienale	FRAME Telaio
A	A	
C*	C*	
E	E	RS-W-N1- GC-BI
G	G	
H*	H*	TC
P*	P*	
TC**	TC**	
CL**	CL**	

\*\*TC/CL = Minimum order 10 pcs each fabric colour  
TC/CL = Ordine minimo 10 pz per colore/tessuto

\*Excluding / Escluso C36+C39, H140+H143, PBS-PCO-PMS-PVE

### FINISHES / Finiture



**SAFETY, STRENGTH and DURABILITY TESTS**  
Prove di sicurezza, resistenza e durata  
EN 1728:2000

OAK  
Rovere

€ 422,00  
€ 469,00  
€ 613,00  
€ 613,00  
€ 483,00  
€ 692,00  
€ 422,00  
€ 482,00

OAK STAINED ON SAMPLE  
Rovere tinto campione

€ 446,00  
€ 493,00  
€ 637,00  
€ 637,00  
€ 508,00  
€ 716,00  
€ 446,00  
€ 506,00

Minimum order q.ty: 20 pcs  
Ordine minimo: 20pz

For fabrics see page 367  
Per i tessuti si veda a p. 367

### PACKING / Imballo



**FABRIC REQUIRED / Fabbisogno tessuto**  
1pc: Lin Mtrs 1,30 (h 1,40)

### TECHNICAL DETAILS / Dettagli tecnici



## Dress 535



SEAT Sedile	BACK Schienale	FRAME Telaio
A	A	
C*	C*	
E	E	RS-W-N1- GC-BI
G	G	
H*	H*	TC
P*	P*	
TC**	TC**	
CL**	CL**	

\*\*TC/CL = Minimum order 10 pcs each fabric colour  
TC/CL = Ordine minimo 10 pz per colore/tessuto

\*Excluding / Escluso C36+C39, H140+H143, PBS-PCO-PMS-PVE

### FINISHES / Finiture



**SAFETY, STRENGTH and DURABILITY TESTS**  
Prove di sicurezza, resistenza e durata  
EN 1728:2000

OAK  
Rovere

€ 442,00  
€ 483,00  
€ 593,00  
€ 593,00  
€ 497,00  
€ 714,00  
€ 442,00  
€ 454,00

OAK STAINED ON SAMPLE  
Rovere tinto campione

€ 466,00  
€ 508,00  
€ 618,00  
€ 618,00  
€ 521,00  
€ 739,00  
€ 466,00  
€ 478,00

Minimum order q.ty: 20 pcs  
Ordine minimo: 20pz

For fabrics see page 367  
Per i tessuti si veda a p. 367

### PACKING / Imballo



**FABRIC REQUIRED / Fabbisogno tessuto**  
1pc: Lin Mtrs 1,50 (h 1,40)

### TECHNICAL DETAILS / Dettagli tecnici

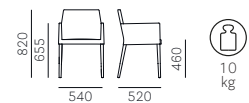

## Dress 536



SEAT Sedile	BACK Schienale	FRAME Telaio	OAK Rovere	OAK STAINED ON SAMPLE Rovere tinto campione
A	A		€ 559,00	€ 583,00
C*	C*		€ 612,00	€ 636,00
E	E	RS-W-N1- GC-BI	€ 758,00	€ 783,00
G	G		€ 758,00	€ 783,00
H*	H*	TC	€ 630,00	€ 654,00
P*	P*		€ 998,00	€ 1.022,00
TC**	TC**		€ 559,00	€ 583,00
CL**	CL**		€ 643,00	€ 668,00

\*\*TC/CL = Minimum order 10 pcs each fabric colour  
TC/CL = Ordine minimo 10 pz per colore/tessuto

\*Excluding / Escluso C36+C39, H140+H143, PBS-PCO-PMS-PVE

For fabrics see page 367  
Per i tessuti si veda a p. 367

PACKING / Imballo

Minimum order q.ty: 20 pcs  
Ordine minimo: 20pz

FINISHES / Finiture



FABRIC REQUIRED / Fabbisogno tessuto  
1pc: Lin Mtrs 1,50 (h 1,40)

TECHNICAL DETAILS / Dettagli tecnici



SAFETY, STRENGTH and DURABILITY TESTS  
Prove di sicurezza, resistenza e durata  
EN 1728:2000

## Elinor 3755



SEAT Sedile	BACK Schienale	FRAME Telaio	BLACK POWDER COATED Verniciato nero	POLISHED ALUMINIUM Alluminio lucidato	BRUSHED ALUMINIUM Alluminio satinato
C210+C217	C210+C217		€ 1.002,00	€ 1.102,00	€ 1.402,00
G*	G*	Ø 810	€ 1.110,00	€ 1.210,00	€ 1.510,00
H*	H*		€ 1.017,00	€ 1.117,00	€ 1.417,00
P*	P*		€ 1.270,00	€ 1.370,00	€ 1.670,00

The armrests in other standard colours are available on request - same price  
Disponibile a richiesta i braccioli verniciati in altri colori standard - allo stesso prezzo

\*Excluding / Escluso G07, G180+G185, G230+G239, H40+H53, H140+H143  
PBS-PCO-PMS-PVE

For fabrics see page 367  
Per i tessuti si veda a p. 367

PACKING / Imballo

TECHNICAL DETAILS / Dettagli tecnici



SAFETY, STRENGTH and DURABILITY TESTS  
Prove di sicurezza, resistenza e durata  
EN 1728:2012+AC2013  
EN 1335-2:2018  
ANSI-BIFMA X5.1-2017

## Elinor 3756

LOW BACK



SEAT Sedile	BACK Schienale	FRAME Telaio	BLACK POWDER COATED Verniciato nero	POLISHED ALUMINIUM Alluminio lucidato	BRUSHED ALUMINIUM Alluminio satinato
C210+C217	C210+C217		€ 962,00	€ 1.062,00	€ 1.362,00
G*	G*	Ø 810	€ 1.070,00	€ 1.170,00	€ 1.470,00
H*	H*		€ 977,00	€ 1.077,00	€ 1.377,00
P*	P*		€ 1.230,00	€ 1.330,00	€ 1.630,00

The armrests in other standard colours are available on request - same price  
Disponibile a richiesta i braccioli verniciati in altri colori standard - allo stesso prezzo

\*Excluding / Escluso G07, G180+G185, G230+G239, H40+H53, H140+H143  
PBS-PCO-PMS-PVE

For fabrics see page 367  
Per i tessuti si veda a p. 367

PACKING / Imballo

TECHNICAL DETAILS / Dettagli tecnici



SAFETY, STRENGTH and DURABILITY TESTS  
Prove di sicurezza, resistenza e durata  
EN 1728:2012+AC2013  
EN 1335-2:2018  
ANSI-BIFMA X5.1-2017

## Elle 452



SEAT Sedile	BACK Schienale	FRAME Telaio	OAK Rovere	OAK STAINED ON SAMPLE Rovere tinto campione
A			€ 255,00	€ 277,00
C*			€ 274,00	€ 296,00
E			€ 339,00	€ 361,00
G	RS-W-N1 - GC-BI	RS-W-N1 - GC-BI	€ 339,00	€ 361,00
H*	TC	TC	€ 286,00	€ 308,00
P*			€ 363,00	€ 385,00
TC**			€ 255,00	€ 277,00
CL**			€ 260,00	€ 282,00

\*\*TC/CL = Minimum order 10 pcs each fabric colour  
TC/CL = Ordine minimo 10 pz per colore/tessuto

\*Excluding / Escluso C36+C39, H140+H143, PBS-PCO-PMS-PVE

### FINISHES / Finiture



For fabrics see page 367  
Per i tessuti si veda a p. 367

### PACKING / Imballo



FABRIC REQUIRED / Fabbisogno tessuto  
1pc: Lin Mtrs 0,45 (h 1,40)

### TECHNICAL DETAILS / Dettagli tecnici

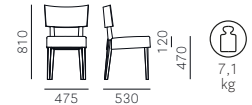

SAFETY, STRENGTH and DURABILITY TESTS  
Prove di sicurezza, resistenza e durata  
EN 1728:2000

## Enjoy 460



SEAT Sedile	BACK Schienale	FRAME Telaio	POLYPROPYLENE Polipropilene
PPL	PPL	PPL	€ 98,00

### PPL FINISHES / Finiture PPL



### PACKING / Imballo



### TECHNICAL DETAILS / Dettagli tecnici

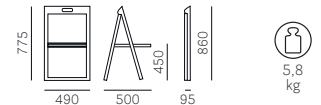

SAFETY, STRENGTH and DURABILITY TESTS  
Prove di sicurezza, resistenza e durata  
EN 1728:2000  
ANSI BIFMA X5.4-2012

## Enjoy 465-466

Trolley  
Carrello



### BLACK POWDER COATED Verniciato nero

€ 472,00

465  
With castors / Con ruote

€ 255,00

466  
Without castors / Senza ruote

### PACKING / Imballo

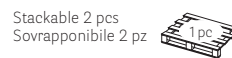

Stackable 2 pcs  
Sovrapponibile 2 pz  
Trolley for Enjoy - 40 pcs  
Carrello porta Enjoy - 40 pz

### TECHNICAL DETAILS / Dettagli tecnici

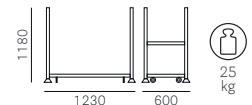

## Ester 691



SEAT Sedile	BACK Schienale	BRUSHED NICKEL Nichel satinato	BRUSHED BRONZE Bronzo satinato	ANTIQU BRASS Ottone anticato	TITANIUM Titanio
G*	G*	€ 790,00	€ 790,00	€ 790,00	€ 790,00
H*	H*	€ 721,00	€ 721,00	€ 721,00	€ 721,00
P*	P*	€ 887,00	€ 887,00	€ 887,00	€ 887,00

Upcharge for double-colour upholstery € 33,00  
Supplemento tappezzeria bicolore € 33,00

\*Excluding / Escluso G100+G102, G130+G133, G200+G206, H82+H89,  
H120+H127, H140+H143, PBS-PCO-PMS-PVE

For fabrics see page 367  
Per i tessuti si veda a p. 367

PACKING / Imballo



TECHNICAL DETAILS / Dettagli tecnici

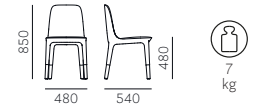

SAFETY, STRENGTH and DURABILITY TESTS  
Prove di sicurezza, resistenza e durata  
EN 1728:2012+AC2013  
EN 16139:2013 level 2

## Ester 690



SEAT Sedile	BACK Schienale	BRUSHED NICKEL Nichel satinato	BRUSHED BRONZE Bronzo satinato	ANTIQU BRASS Ottone anticato	TITANIUM Titanio
G*	G*	€ 949,00	€ 949,00	€ 949,00	€ 949,00
H*	H*	€ 847,00	€ 847,00	€ 847,00	€ 847,00
P*	P*	€ 1.038,00	€ 1.038,00	€ 1.038,00	€ 1.038,00

Upcharge for double-colour upholstery € 33,00  
Supplemento tappezzeria bicolore € 33,00

\*Excluding / Escluso G100+G102, G130+G133, G200+G206, H82+H89,  
H120+H127, H140+H143, PBS-PCO-PMS-PVE

For fabrics see page 367  
Per i tessuti si veda a p. 367

PACKING / Imballo



TECHNICAL DETAILS / Dettagli tecnici

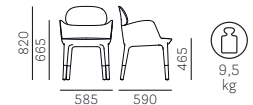

SAFETY, STRENGTH and DURABILITY TESTS  
Prove di sicurezza, resistenza e durata  
EN 1728:2012+AC2013  
EN 16139:2013 level 2

## Ester 695



SEAT Sedile	BACK Schienale	BLACK POWDER COATED Verniciato nero	POLISHED ALUMINIUM Alluminio lucidato
G*	G*	€ 920,00	€ 920,00
H*	H*	€ 842,00	€ 842,00
P*	P*	€ 1.036,00	€ 1.036,00

Chromed inner column  
Colonna interna cromata

Upcharge for double-colour upholstery € 33,00  
Supplemento tappezzeria bicolore € 33,00

\*Excluding / Escluso G100+G102, G130+G133, G200+G206, H82+H89,  
H120+H127, H140+H143, PBS-PCO-PMS-PVE

For fabrics see page 367  
Per i tessuti si veda a p. 367

PACKING / Imballo



TECHNICAL DETAILS / Dettagli tecnici





## Ester 695F



SEAT Sedile	BACK Schienale	BLACK POWDER COATED Verniciato nero	POLISHED ALUMINIUM Alluminio lucidato
G*	G*	<b>€ 942,00</b>	<b>€ 942,00</b>
H*	H*	<b>€ 864,00</b>	<b>€ 864,00</b>
P*	P*	<b>€ 1.058,00</b>	<b>€ 1.058,00</b>

Upcharge for double-colour upholstery € 33,00  
Supplemento tappezzeria bicolore € 33,00

\*Excluding / Escluso G100+G102, G130+G133, G200+G206, H82+H89,  
H120+H127, H140+H143, PBS-PCO-PMS-PVE

For fabrics see page 367  
Per i tessuti si veda a p. 367

PACKING / Imballo



TECHNICAL DETAILS / Dettagli tecnici



## Ester 696

High back  
Schienale alto



SEAT Sedile	BACK Schienale	BLACK POWDER COATED Verniciato nero	POLISHED ALUMINIUM Alluminio lucidato
G*	G*	<b>€ 1.012,00</b>	<b>€ 1.012,00</b>
H*	H*	<b>€ 926,00</b>	<b>€ 926,00</b>
P*	P*	<b>€ 1.139,00</b>	<b>€ 1.139,00</b>

Upcharge for double-colour upholstery € 33,00  
Supplemento tappezzeria bicolore € 33,00

\*Excluding / Escluso G100+G102, G130+G133, G200+G206, H82+H89,  
H120+H127, H140+H143, PBS-PCO-PMS-PVE

For fabrics see page 367  
Per i tessuti si veda a p. 367

PACKING / Imballo



TECHNICAL DETAILS / Dettagli tecnici



## Ester 696F

High back  
Schienale alto



SEAT Sedile	BACK Schienale	BLACK POWDER COATED Verniciato nero	POLISHED ALUMINIUM Alluminio lucidato
G*	G*	<b>€ 1.034,00</b>	<b>€ 1.034,00</b>
H*	H*	<b>€ 948,00</b>	<b>€ 948,00</b>
P*	P*	<b>€ 1.161,00</b>	<b>€ 1.161,00</b>

Upcharge for double-colour upholstery € 33,00  
Supplemento tappezzeria bicolore € 33,00

\*Excluding / Escluso G100+G102, G130+G133, G200+G206, H82+H89,  
H120+H127, H140+H143, PBS-PCO-PMS-PVE

For fabrics see page 367  
Per i tessuti si veda a p. 367

PACKING / Imballo



TECHNICAL DETAILS / Dettagli tecnici



## Ester 693

POUF



SEAT Sedile	BRUSHED NICKEL Nichel satinato	BRUSHED BRONZE Bronzo satinato	ANTIQUÉ BRASS Ottone anticato	TITANIUM Titanio
G*	€ 602,00	€ 602,00	€ 602,00	€ 602,00
H*	€ 552,00	€ 552,00	€ 552,00	€ 552,00
P*	€ 713,00	€ 713,00	€ 713,00	€ 713,00

\*Excluding / Escluso G100+G102, G130+G133, G200+G206, H82+H89, H120+H127, H140+H143, PBS-PCO-PMS-PVE

For fabrics see page 367  
Per i tessuti si veda a p. 367

PACKING / Imballo

TECHNICAL DETAILS / Dettagli tecnici



## Ester 698\_H650



SEAT Sedile	BACK Schienale	FRAME Telaio	BRUSHED NICKEL Nichel satinato	BRUSHED BRONZE Bronzo satinato	ANTIQUÉ BRASS Ottone anticato	TITANIUM Titanio
G*	G*		€ 972,00	€ 972,00	€ 972,00	€ 972,00
H*	H*	H650	€ 895,00	€ 895,00	€ 895,00	€ 895,00
P*	P*		€ 1.130,00	€ 1.130,00	€ 1.130,00	€ 1.130,00

Upcharge for double-colour upholstery € 33,00  
Supplemento tappezzeria bicolore € 33,00

\*Excluding / Escluso G100+G102, G130+G133, G200+G206, H82+H89, H120+H127, H140+H143, PBS-PCO-PMS-PVE

For fabrics see page 367  
Per i tessuti si veda a p. 367

PACKING / Imballo

TECHNICAL DETAILS / Dettagli tecnici

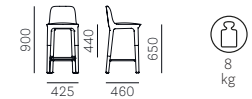

## Ester 698



SEAT Sedile	BACK Schienale	FRAME Telaio	BRUSHED NICKEL Nichel satinato	BRUSHED BRONZE Bronzo satinato	ANTIQUÉ BRASS Ottone anticato	TITANIUM Titanio
G*	G*		€ 950,00	€ 950,00	€ 950,00	€ 950,00
H*	H*	H750	€ 873,00	€ 873,00	€ 873,00	€ 873,00
P*	P*		€ 1.108,00	€ 1.108,00	€ 1.108,00	€ 1.108,00

Upcharge for double-colour upholstery € 33,00  
Supplemento tappezzeria bicolore € 33,00

\*Excluding / Escluso G100+G102, G130+G133, G200+G206, H82+H89, H120+H127, H140+H143, PBS-PCO-PMS-PVE

For fabrics see page 367  
Per i tessuti si veda a p. 367

PACKING / Imballo

TECHNICAL DETAILS / Dettagli tecnici







## Folk 2930



SEAT Sedile	BACK Schienale	FRAME Telaio	ASH Frassino		ASH STAINED ON SAMPLE Frassino tinto campione	
			POWDER COATED Verniciato	POLISHED ALUMINIUM Alluminio lucidato	POWDER COATED Verniciato	POLISHED ALUMINIUM Alluminio lucidato
FR-N1-GC-BI-AN	FR-N1-GC-BI-AN	FR-N1-GC-BI-AN	€ 281,00	€ 304,00		
TC	TC	TC			€ 303,00	€ 326,00

FINISHES / Finiture

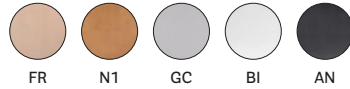

PACKING / Imballo



TECHNICAL DETAILS / Dettagli tecnici

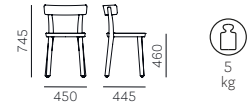

SAFETY, STRENGTH and DURABILITY TESTS  
Prove di sicurezza, resistenza e durata  
EN 1728:2012+AC2013  
EN 16139:2013 level 2

## Folk 2920



SEAT Sedile	BACK Schienale	FRAME Telaio	ASH Frassino		ASH STAINED ON SAMPLE Frassino tinto campione	
			POWDER COATED Verniciato	POLISHED ALUMINIUM Alluminio lucidato	POWDER COATED Verniciato	POLISHED ALUMINIUM Alluminio lucidato
Cane / Canna	FR-N1-GC-BI-AN	FR-N1-GC-BI-AN	€ 333,00	€ 356,00		
	TC	TC			€ 355,00	€ 378,00

FINISHES / Finiture

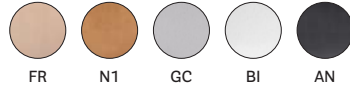

PACKING / Imballo



TECHNICAL DETAILS / Dettagli tecnici

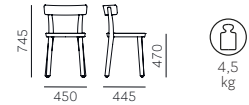

SAFETY, STRENGTH and DURABILITY TESTS  
Prove di sicurezza, resistenza e durata  
EN 1728:2012+AC2013  
EN 16139:2013 level 2

## Folk 2940



SEAT Sedile	BACK Schienale	FRAME Telaio	ASH Frassino		ASH STAINED ON SAMPLE Frassino tinto campione	
			POWDER COATED Verniciato	POLISHED ALUMINIUM Alluminio lucidato	POWDER COATED Verniciato	POLISHED ALUMINIUM Alluminio lucidato
A	FR-N1-GC-BI-AN	FR-N1-GC-BI-AN	€ 281,00	€ 304,00	€ 303,00	€ 326,00
C*			€ 289,00	€ 312,00	€ 311,00	€ 334,00
D40+D44			€ 299,00	€ 322,00	€ 321,00	€ 344,00
E			€ 314,00	€ 337,00	€ 336,00	€ 359,00
G			€ 314,00	€ 337,00	€ 336,00	€ 359,00
H*			€ 292,00	€ 315,00	€ 314,00	€ 337,00
P*			€ 372,00	€ 395,00	€ 394,00	€ 417,00
TC**			€ 281,00	€ 304,00	€ 303,00	€ 326,00
CL**			€ 286,00	€ 310,00	€ 308,00	€ 332,00

\*\*TC/CL = Minimum order 10 pcs each fabric colour  
TC/CL = Ordine minimo 10 pz per colore/tessuto

\*Excluding / Escluso C36+C39, H140+H143, PBS-PCO-PMS-PVE

FINISHES / Finiture



For fabrics see page 367  
Per i tessuti si veda a p. 367

PACKING / Imballo



TECHNICAL DETAILS / Dettagli tecnici



SAFETY, STRENGTH and DURABILITY TESTS  
Prove di sicurezza, resistenza e durata  
EN 1728:2012+AC2013  
EN 16139:2013 level 2

FABRIC REQUIRED / Fabbisogno tessuto

1pc: Lin Mtrs 0,30 (h 1,40)  
fabric and simil leather / tessuto e finta pelle  
1pc: Square Mtrs 0,60 mid-grain leather / pelle mezzo fiore

For colours and finishes see at page 362  
Per colori e finiture vedere da pagina 362



## Folk 2936



SEAT Sedile	BACK Schienale	FRAME Telaio	ASH Frassino		ASH STAINED ON SAMPLE Frassino tinto campione	
			POWDER COATED Verniciato	POLISHED ALUMINIUM Alluminio lucidato	POWDER COATED Verniciato	POLISHED ALUMINIUM Alluminio lucidato
FR-N1-GC-BI-AN	FR-N1-GC-BI-AN	H650	€ 383,00	€ 420,00	€ 405,00	€ 442,00
TC	TC					

### FINISHES / Finiture

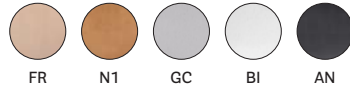

### PACKING / Imballo



### TECHNICAL DETAILS / Dettagli tecnici

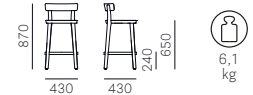

**SAFETY, STRENGTH and DURABILITY TESTS**  
 Prove di sicurezza, resistenza e durata  
 EN 1728:2012+AC2013  
 EN 16139:2013 level 2

## Folk 2926



SEAT Sedile	BACK Schienale	FRAME Telaio	ASH Frassino		ASH STAINED ON SAMPLE Frassino tinto campione	
			POWDER COATED Verniciato	POLISHED ALUMINIUM Alluminio lucidato	POWDER COATED Verniciato	POLISHED ALUMINIUM Alluminio lucidato
Cane / Canna	FR-N1-GC-BI-AN	H650	€ 435,00	€ 471,00	€ 457,00	€ 493,00
	TC					

### FINISHES / Finiture

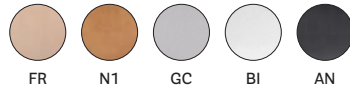

### PACKING / Imballo



### TECHNICAL DETAILS / Dettagli tecnici

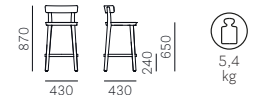

**SAFETY, STRENGTH and DURABILITY TESTS**  
 Prove di sicurezza, resistenza e durata  
 EN 1728:2012+AC2013  
 EN 16139:2013 level 2

## Folk 2946



SEAT Sedile	BACK Schienale	FRAME Telaio	ASH Frassino		ASH STAINED ON SAMPLE Frassino tinto campione	
			POWDER COATED Verniciato	POLISHED ALUMINIUM Alluminio lucidato	POWDER COATED Verniciato	POLISHED ALUMINIUM Alluminio lucidato
A	FR-N1-GC-BI-AN	H690	€ 383,00	€ 420,00	€ 405,00	€ 442,00
C*			€ 391,00	€ 427,00	€ 413,00	€ 449,00
D40+D44			€ 401,00	€ 437,00	€ 423,00	€ 459,00
E			€ 416,00	€ 453,00	€ 438,00	€ 475,00
G			€ 416,00	€ 453,00	€ 438,00	€ 475,00
H*			€ 394,00	€ 431,00	€ 416,00	€ 453,00
P*			€ 475,00	€ 511,00	€ 497,00	€ 533,00
TC**			€ 383,00	€ 420,00	€ 405,00	€ 442,00
CL**			€ 389,00	€ 425,00	€ 411,00	€ 447,00

\*\*TC/CL = Minimum order 10 pcs each fabric colour  
 TC/CL = Ordine minimo 10 pz per colore/tessuto

\*Excluding / Escluso C36+C39, H140+H143, PBS-PCO-PMS-PVE

### FINISHES / Finiture



For fabrics see page 367  
 Per i tessuti si veda a p. 367

### PACKING / Imballo



### TECHNICAL DETAILS / Dettagli tecnici



**SAFETY, STRENGTH and DURABILITY TESTS**  
 Prove di sicurezza, resistenza e durata  
 EN 1728:2012+AC2013  
 EN 16139:2013 level 2

### FABRIC REQUIRED / Fabbisogno tessuto

1 pc: Lin Mtrs 0,30 (h 1,40)  
 fabric and simil leather / tessuto e finta pelle  
 1 pc: Square Mtrs 0,60 mid-grain leather / pelle mezzo fiore

For colours and finishes see at page 362  
 Per colori e finiture vedere da pagina 362



## Folk 2937



SEAT Sedile	BACK Schienale	FRAME Telaio	ASH Frassino		ASH STAINED ON SAMPLE Frassino tinto campione	
			POWDER COATED Verniciato	POLISHED ALUMINIUM Alluminio lucidato	POWDER COATED Verniciato	POLISHED ALUMINIUM Alluminio lucidato
FR-N1-GC-BI-AN	FR-N1-GC-BI-AN	H750	€ 388,00	€ 424,00	€ 410,00	€ 446,00
TC	TC					

FINISHES / Finiture

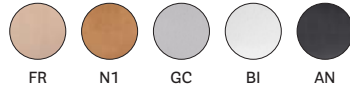

PACKING / Imballo



TECHNICAL DETAILS / Dettagli tecnici

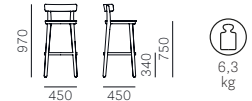

SAFETY, STRENGTH and DURABILITY TESTS  
Prove di sicurezza, resistenza e durata  
EN 1728:2012+AC2013  
EN 16139:2013 level 2

## Folk 2927



SEAT Sedile	BACK Schienale	FRAME Telaio	ASH Frassino		ASH STAINED ON SAMPLE Frassino tinto campione	
			POWDER COATED Verniciato	POLISHED ALUMINIUM Alluminio lucidato	POWDER COATED Verniciato	POLISHED ALUMINIUM Alluminio lucidato
Cane / Canna	FR-N1-GC-BI-AN	H750	€ 439,00	€ 476,00	€ 461,00	€ 498,00
	TC					

FINISHES / Finiture



PACKING / Imballo



TECHNICAL DETAILS / Dettagli tecnici

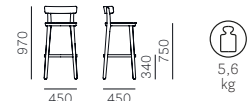

SAFETY, STRENGTH and DURABILITY TESTS  
Prove di sicurezza, resistenza e durata  
EN 1728:2012+AC2013  
EN 16139:2013 level 2

## Folk 2947



SEAT Sedile	BACK Schienale	FRAME Telaio	ASH Frassino		ASH STAINED ON SAMPLE Frassino tinto campione	
			POWDER COATED Verniciato	POLISHED ALUMINIUM Alluminio lucidato	POWDER COATED Verniciato	POLISHED ALUMINIUM Alluminio lucidato
A	FR-N1-GC-BI-AN	H790	€ 388,00	€ 424,00	€ 410,00	€ 446,00
C*			€ 395,00	€ 432,00	€ 417,00	€ 454,00
D40÷D44			€ 405,00	€ 442,00	€ 427,00	€ 464,00
E			€ 421,00	€ 457,00	€ 443,00	€ 479,00
G			€ 421,00	€ 457,00	€ 443,00	€ 479,00
H*			€ 399,00	€ 435,00	€ 421,00	€ 457,00
P*			€ 479,00	€ 515,00	€ 501,00	€ 537,00
TC**			€ 388,00	€ 424,00	€ 410,00	€ 446,00
CL**			€ 393,00	€ 429,00	€ 415,00	€ 451,00

\*\*TC/CL = Minimum order 10 pcs each fabric colour  
TC/CL = Ordine minimo 10 pz per colore/tessuto

\*Excluding / Escluso C36+C39, H140+H143, PBS-PCO-PMS-PVE

FINISHES / Finiture



For fabrics see page 367  
Per i tessuti si veda a p. 367

PACKING / Imballo



TECHNICAL DETAILS / Dettagli tecnici

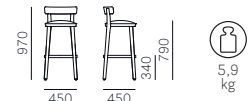

SAFETY, STRENGTH and DURABILITY TESTS  
Prove di sicurezza, resistenza e durata  
EN 1728:2012+AC2013  
EN 16139:2013 level 2

FABRIC REQUIRED / Fabbisogno tessuto

1 pc: Lin Mtrs 0,30 (h 1,40)  
fabric and simil leather / tessuto e finta pelle  
1 pc: Square Mtrs 0,60 mid-grain leather / pelle mezzo fiore

For colours and finishes see at page 362  
Per colori e finiture vedere da pagina 362



## Fox 3725



SEAT Sedile	BACK Schienale	FRAME Telaio	BLEACHED ASH Frassino sbiancato	BLACK LACQUERED ASH Frassino laccato nero
PPL	PPL + FR	FR	<b>€ 231,00</b> (BI, SA, BL)	
PPL	PPL + AN	AN		<b>€ 231,00</b> (BL, ML, NE)

PPL FINISHES / Finiture PPL



WOODEN FINISHES / Finiture legno



PACKING / Imballo



TECHNICAL DETAILS / Dettagli tecnici



**SAFETY, STRENGTH and DURABILITY TESTS**  
Prove di sicurezza, resistenza e durata  
EN 1728:2012+AC2013  
EN 16139:2013 level 2



## Fox 3727



SEAT Sedile	BACK Schienale	FRAME Telaio	BLEACHED ASH Frassino sbiancato	BLACK LACQUERED ASH Frassino laccato nero
F04	F04 + FR	FR	<b>€ 506,00</b>	
F04+F05	F04+F05 + AN	AN		<b>€ 506,00</b>

GENUINE LEATHER FINISHES / Finiture cuoio naturale



WOODEN FINISHES / Finiture legno



PACKING / Imballo



TECHNICAL DETAILS / Dettagli tecnici



**SAFETY, STRENGTH and DURABILITY TESTS**  
Prove di sicurezza, resistenza e durata  
EN 1728:2012+AC2013  
EN 16139:2013 level 2



## Fox 3723



SEAT Sedile	BACK Schienale	FRAME Telaio	ASH Frassino
C83+C89; C100+C101 C110+C122 C210+C217	C83+C89; C100+C101 C110+C122 C210+C217		<b>€ 517,00</b>
E	E		<b>€ 601,00</b>
G21+G24 G100+G102 G110+G116 G140+G146 G150+G156 G180+G185 G230+G239	G21+G24 G100+G102 G110+G116 G140+G146 G150+G156 G180+G185 G230+G239	FR-AN	<b>€ 601,00</b>
H40+H53 H120+H127	H40+H53 H120+H127		<b>€ 528,00</b>

WOODEN FINISHES / Finiture legno



PACKING / Imballo



TECHNICAL DETAILS / Dettagli tecnici



**SAFETY, STRENGTH and DURABILITY TESTS**  
Prove di sicurezza, resistenza e durata  
EN 1728:2012+AC2013  
EN 16139:2013 level 2

For fabrics see page 367  
Per i tessuti si veda a p. 367





## Fox 3726



SEAT Sedile	BACK Schienale	FRAME Telaio	BEIGE POWDER COATED Verniciato beige	SAND POWDER COATED Verniciato sabbia	BLACK POWDER COATED Verniciato nero
PPL	PPL + FR	Ø 14	€ 171,00 (BI)	€ 171,00 (SA, BL)	€ 171,00 (BI, ML, NE)
PPL	PPL + AN				

PPL FINISHES / Finiture PPL



WOODEN FINISHES  
Finiture legno



POWDER COATED FINISHES  
Finiture verniciato



PACKING / Imballo



TECHNICAL DETAILS / Dettagli tecnici



SAFETY, STRENGTH and DURABILITY TESTS  
Prove di sicurezza, resistenza e durata  
EN 1728:2012+AC2013  
EN 16139:2013 level 2



## Fox 3728



SEAT Sedile	BACK Schienale	FRAME Telaio	BLACK POWDER COATED Verniciato nero
F04	F04 + FR	Ø 14	€ 446,00
F04+F05	F04+F05 + AN		

GENUINE LEATHER FINISHES / Finiture cuoio naturale



WOODEN FINISHES  
Finiture legno



POWDER COATED FINISH  
Finitura verniciato



PACKING / Imballo



TECHNICAL DETAILS / Dettagli tecnici



SAFETY, STRENGTH and DURABILITY TESTS  
Prove di sicurezza, resistenza e durata  
EN 1728:2012+AC2013  
EN 16139:2013 level 2



## Fox 3724



SEAT Sedile	BACK Schienale	FRAME Telaio	BLACK POWDER COATED Verniciato nero
C83+C89; C100+C101 C110+C122 C210+C217	C83+C89; C100+C101 C110+C122 C210+C217	Ø 14	€ 457,00
E	E		€ 541,00
G21+G24 G100+G102 G110+G116 G140+G146 G150+G156 G180+G185 G230+G239	G21+G24 G100+G102 G110+G116 G140+G146 G150+G156 G180+G185 G230+G239		€ 541,00
H40+H53 H120+H127	H40+H53 H120+H127		€ 468,00

WOODEN FINISHES / Finiture legno



PACKING / Imballo



TECHNICAL DETAILS / Dettagli tecnici



SAFETY, STRENGTH and DURABILITY TESTS  
Prove di sicurezza, resistenza e durata  
EN 1728:2012+AC2013  
EN 16139:2013 level 2

For fabrics see page 367  
Per i tessuti si veda a p. 367



## Frida 752



SEAT Sedile	BACK Schienale	FRAME Telaio	OAK Rovere	OAK STAINED ON SAMPLE Rovere tinto campione
RS-W-N1- GC-BI	RS-W-N1- GC-BI	RS-W-N1- GC-BI	<b>€ 479,00</b>	<b>€ 501,00</b>
TC	TC	TC		

### FINISHES / Finiture



### PACKING / Imballo



### TECHNICAL DETAILS / Dettagli tecnici

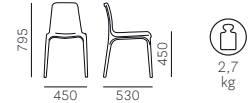

**SAFETY, STRENGTH and DURABILITY TESTS**  
Prove di sicurezza, resistenza e durata  
EN 1728:2000



## Frida 752



SEAT Sedile	BACK Schienale	FRAME Telaio	OAK Rovere
BL2 AZ1 VE2 VE1 RB RA MO MC	BL2 AZ1 VE2 VE1 RB RA MO MC	BL2 AZ1 VE2 VE1 RB RA MO MC	<b>€ 490,00</b> Lacquered with visible grains Laccato a poro aperto

### FINISHES / Finiture



### PACKING / Imballo



### TECHNICAL DETAILS / Dettagli tecnici

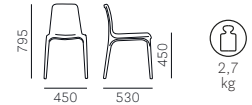

**SAFETY, STRENGTH and DURABILITY TESTS**  
Prove di sicurezza, resistenza e durata  
EN 1728:2000



## Glam 430



SEAT Sedile	BACK Schienale	FRAME Telaio	OAK Rovere	OAK STAINED ON SAMPLE Rovere tinto campione
A			€ 249,00	€ 271,00
C*			€ 263,00	€ 285,00
G	RS-W-N1- GC-BI	RS-W-N1- GC-BI	€ 307,00	€ 329,00
H*			€ 267,00	€ 289,00
P*	TC	TC	€ 315,00	€ 337,00
TC**			€ 249,00	€ 271,00
CL**			€ 255,00	€ 277,00

\*\*TC/CL = Minimum order 10 pcs each fabric colour  
TC/CL = Ordine minimo 10 pz per colore/tessuto

\*Excluding / Escluso C36+C39, H140+H143, PBS-PCO-PMS-PVE

### FINISHES / Finiture



For fabrics see page 367  
Per i tessuti si veda a p. 367

### PACKING / Imballo



FABRIC REQUIRED / Fabbisogno tessuto  
1pc: Lin Mtrs 0,50 (h 1,40)

### TECHNICAL DETAILS / Dettagli tecnici

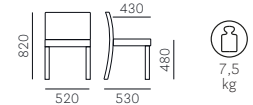

## Glam 431



SEAT Sedile	BACK Schienale	FRAME Telaio	OAK Rovere	OAK STAINED ON SAMPLE Rovere tinto campione
A			€ 249,00	€ 271,00
C*			€ 263,00	€ 285,00
G	RS-W-N1- GC-BI	RS-W-N1- GC-BI	€ 307,00	€ 329,00
H*			€ 267,00	€ 289,00
P*	TC	TC	€ 315,00	€ 337,00
TC**			€ 249,00	€ 271,00
CL**			€ 255,00	€ 277,00

\*\*TC/CL = Minimum order 10 pcs each fabric colour  
TC/CL = Ordine minimo 10 pz per colore/tessuto

\*Excluding / Escluso C36+C39, H140+H143, PBS-PCO-PMS-PVE

### FINISHES / Finiture



For fabrics see page 367  
Per i tessuti si veda a p. 367

### PACKING / Imballo



FABRIC REQUIRED / Fabbisogno tessuto  
1pc: Lin Mtrs 0,50 (h 1,40)

### TECHNICAL DETAILS / Dettagli tecnici

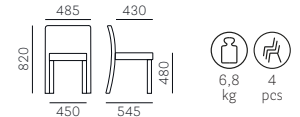

SAFETY, STRENGTH and DURABILITY TESTS  
Prove di sicurezza, resistenza e durata  
EN 1728:2000

## Glam 432



SEAT Sedile	BACK Schienale	FRAME Telaio	OAK Rovere
A			€ 264,00
C*			€ 283,00
G	Cane / Canna	RS-W	€ 326,00
H*			€ 291,00
P*			€ 346,00
TC**			€ 264,00
CL**			€ 271,00

\*\*TC/CL = Minimum order 10 pcs each fabric colour  
TC/CL = Ordine minimo 10 pz per colore/tessuto

\*Excluding / Escluso C36+C39, H140+H143, PBS-PCO-PMS-PVE

### WOODEN FINISHES / Finiture legno



### CANE FINISHES / Finiture canna



For fabrics see page 367  
Per i tessuti si veda a p. 367

### PACKING / Imballo



FABRIC REQUIRED / Fabbisogno tessuto  
1pc: Lin Mtrs 0,50 (h 1,40)

### TECHNICAL DETAILS / Dettagli tecnici

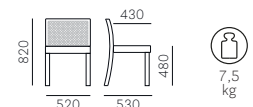

## Glam 433



SEAT Sedile	BACK Schienale	FRAME Telaio	OAK Rovere
A			€ 264,00
C*			€ 283,00
G	Cane / Canna	RS-W	€ 326,00
H*			€ 291,00
P*			€ 346,00
TC**			€ 264,00
CL**			€ 271,00

\*\*TC/CL = Minimum order 10 pcs each fabric colour  
TC/CL = Ordine minimo 10 pz per colore/tessuto

\*Excluding / Escluso C36+C39, H140+H143, PBS-PCO-PMS-PVE

### WOODEN FINISHES / Finiture legno



RS W

### CANE FINISHES / Finiture canna



RS W

For fabrics see page 367  
Per i tessuti si veda a p. 367

### PACKING / Imballo



FABRIC REQUIRED / Fabbisogno tessuto  
1pc: Lin Mtrs 0,50 (h 1,40)

### TECHNICAL DETAILS / Dettagli tecnici

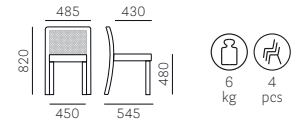

## Glam 435



SEAT Sedile	BACK Schienale	FRAME Telaio	OAK Rovere	OAK STAINED ON SAMPLE Rovere tinto campione
A	A		€ 273,00	€ 295,00
C*	C*		€ 304,00	€ 326,00
G	G	RS-W-N1- GC-BI	€ 363,00	€ 385,00
H*	H*		€ 299,00	€ 321,00
P*	P*	TC	€ 399,00	€ 421,00
TC**	TC**		€ 273,00	€ 295,00
CL**	CL**		€ 279,00	€ 301,00

\*\*TC/CL = Minimum order 10 pcs each fabric colour  
TC/CL = Ordine minimo 10 pz per colore/tessuto

\*Excluding / Escluso C36+C39, H140+H143, PBS-PCO-PMS-PVE

### FINISHES / Finiture



RS W N1 GC BI

For fabrics see page 367  
Per i tessuti si veda a p. 367

### PACKING / Imballo



FABRIC REQUIRED / Fabbisogno tessuto  
1pc: Lin Mtrs 0,90 (h 1,40)

### TECHNICAL DETAILS / Dettagli tecnici

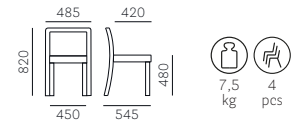

## Gliss 900.3

Cushion only  
Solo cuscino



SEAT Sedile	FABRIC Tessuto
A	€ 61,00
C	€ 75,00
E	€ 120,00
G	€ 120,00
H*	€ 80,00
TC**	€ 61,00

\*\*TC = Minimum order 10 pcs each fabric colour. Feasibility to be approved  
TC = Ordine minimo 10 pz per colore/tessuto. Fattibilità da valutare

\*Excluding / Escluso H140+H143

For fabrics see page 367  
Per i tessuti si veda a p. 367

PACKING / Imballo



FABRIC REQUIRED / Fabbisogno tessuto  
On request / A richiesta

TECHNICAL DETAILS / Dettagli tecnici

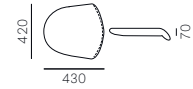

## Gliss 900.8

Fabric covering only  
Solo vestina



SEAT Sedile	BACK Schienale	FABRIC Tessuto
A	A	€ 225,00
C*	C*	€ 265,00
E	E	€ 397,00
G	G	€ 397,00
H*	H*	€ 276,00

For technopolymer shell only  
Solo per scocca tecnopolimero

\*Excluding / Escluso C36+C39, H140+H143

For fabrics see page 367  
Per i tessuti si veda a p. 367

PACKING / Imballo



FABRIC REQUIRED / Fabbisogno tessuto  
On request / A richiesta

TECHNICAL DETAILS / Dettagli tecnici



## Gliss 904

WOOD



SEAT Sedile	BACK Schienale	FRAME Telaio	ASH Frassino	ASH STAINED ON SAMPLE Frassino tinto campione
TP	TP	FR-N1-AN	<b>€ 173,00</b>	<b>€ 197,00</b>
TP	TP	TC		

White powder-coated steel rod frame, for BI shell with FR frame. Black powder-coated steel rod frame for other versions  
Telaio in tondino verniciato bianco, per scocca BI con telaio FR. Telaio in tondino verniciato nero per le altre versioni

TP FINISHES / Finiture TP



BI

SA

WOODEN FINISHES / Finiture legno



FR

AN

N1

PACKING / Imballo



TECHNICAL DETAILS / Dettagli tecnici



SAFETY, STRENGTH and DURABILITY TESTS  
Prove di sicurezza, resistenza e durata  
EN 1728:2000



## Gliss 905

WOOD



SEAT Sedile	BACK Schienale	FRAME Telaio	ASH Frassino	ASH STAINED ON SAMPLE Frassino tinto campione
PC	PC	FR-N1-AN	<b>€ 190,00</b>	<b>€ 214,00</b>
PC	PC	TC *		

\*Steel rod frame under the seat, black powder coated  
Telaio tondino verniciato nero

PC FINISHES / Finiture PC



FU

TR

VT

RT

NE

WOODEN FINISHES / Finiture legno



FR

AN

N1

PACKING / Imballo



TECHNICAL DETAILS / Dettagli tecnici



SAFETY, STRENGTH and DURABILITY TESTS  
Prove di sicurezza, resistenza e durata  
EN 1728:2000



## Gliss 920



SEAT Sedile	BACK Schienale	FRAME Telaio	POWDER COATED Verniciato	CHROMED Cromato
TP	TP	Ø 10	<b>€ 96,00</b>	<b>€ 96,00</b>

TP FINISHES / Finiture TP



BI

SA

PACKING / Imballo



TECHNICAL DETAILS / Dettagli tecnici



SAFETY, STRENGTH and DURABILITY TESTS  
Prove di sicurezza, resistenza e durata  
EN 1022:1998

For colours and finishes see at page 362  
Per colori e finiture vedere da pagina 362



## Gliss 921



SEAT Sedile	BACK Schienale	FRAME Telaio	POWDER COATED Verniciato	CHROMED Cromato
PC	PC	Ø 10	€ 115,00	€ 115,00

PC FINISHES / Finiture PC



PACKING / Imballo



TECHNICAL DETAILS / Dettagli tecnici



SAFETY, STRENGTH and DURABILITY TESTS  
Prove di sicurezza, resistenza e durata  
EN 1022:1998  
EN 1728:2000

## Gliss 921/CL1

Fire retardant version  
Versione ignifuga



SEAT Sedile	BACK Schienale	FRAME Telaio	POWDER COATED Verniciato	CHROMED Cromato
PC	PC	Ø 10	€ 133,00	€ 133,00

Minimum order 300 pcs  
Ordine minimo 300 pz

PC FINISHES / Finiture PC



PACKING / Imballo



TECHNICAL DETAILS / Dettagli tecnici



SAFETY, STRENGTH and DURABILITY TESTS  
Prove di sicurezza, resistenza e durata  
EN 1022:1998  
EN 1728:2000

## Gliss 940



SEAT Sedile	BACK Schienale	FRAME Telaio	BRUSHED S/STEEL Inox satinato	POLISHED S/STEEL Inox lucidato
TP	TP	Ø 400	€ 203,00	€ 215,00

TP FINISHES / Finiture TP



PACKING / Imballo



TECHNICAL DETAILS / Dettagli tecnici

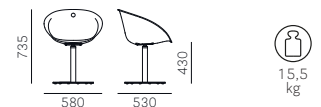

For colours and finishes see at page 362  
Per colori e finiture vedere da pagina 362



## Gliss 941



SEAT Sedile	BACK Schienale	FRAME Telaio	BRUSHED S/STEEL Inox satinato	POLISHED S/STEEL Inox lucidato
PC	PC	Ø 400	€ 220,00	€ 232,00

PC FINISHES / Finiture PC



NE

PACKING / Imballo



TECHNICAL DETAILS / Dettagli tecnici



## Gliss 950

Gas lift device  
Alzata a gas



SEAT Sedile	BACK Schienale	FRAME Telaio	CHROMED Cromato
TP	TP	Ø 400	€ 230,00

TP FINISHES / Finiture TP



BI

SA

PACKING / Imballo



TECHNICAL DETAILS / Dettagli tecnici

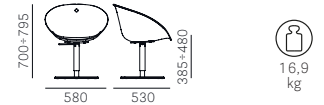

## Gliss 951

Gas lift device  
Alzata a gas



SEAT Sedile	BACK Schienale	FRAME Telaio	CHROMED Cromato
PC	PC	Ø 400	€ 247,00

PC FINISHES / Finiture PC



FU

TR

VT

RT

PACKING / Imballo



TECHNICAL DETAILS / Dettagli tecnici



PRODUCT CERTIFIED  
FOR LOW CHEMICAL  
EMISSIONS:  
UL.COM/MGG  
UL 2818



## Gliss 952

Gas lift device  
Alzata a gas



SEAT Sedile	BACK Schienale	FRAME Telaio	CHROMED Cromato
PC	PC	Ø 400	€ 247,00

PC FINISHES / Finiture PC



PACKING / Imballo



TECHNICAL DETAILS / Dettagli tecnici

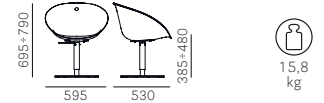

## Gliss 960/2

Gas lift device  
Alzata a gas



SEAT Sedile	BACK Schienale	FRAME Telaio	WHITE/BLACK POWDER COATED Verniciato bianco/nero	POLISHED ALUMINIUM Alluminio lucidato
TP	TP	Ø 750	€ 179,00	€ 239,00

TP FINISHES / Finiture TP



PACKING / Imballo



TECHNICAL DETAILS / Dettagli tecnici



## Gliss 961/2

Gas lift device  
Alzata a gas



SEAT Sedile	BACK Schienale	FRAME Telaio	BLACK POWDER COATED Verniciato nero	POLISHED ALUMINIUM Alluminio lucidato
PC	PC	Ø 750	€ 196,00	€ 256,00

PC FINISHES / Finiture PC



PACKING / Imballo



TECHNICAL DETAILS / Dettagli tecnici

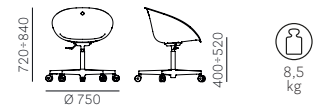

## Gliss 968



SEAT Sedile	BACK Schienale	FRAME Telaio	CHROMED Cromato
PC	PC	Ø 16	<b>€ 186,00</b>

PC FINISHES / Finiture PC



PACKING / Imballo



TECHNICAL DETAILS / Dettagli tecnici



## Gliss 904/F

WOOD



SEAT Sedile	BACK Schienale	FRAME Telaio	ASH Frassino	ASH STAINED ON SAMPLE Frassino tinto campione
F01; F04+F09	F01; F04+F09	FR-AN-N1	<b>€ 763,00</b>	
F01; F04+F09	F01; F04+F09	TC *		<b>€ 789,00</b>

\*Steel rod frame under the seat, black powder coated  
Telaio tondino verniciato nero

For fabrics see page 367  
Per i tessuti si veda a p. 367

WOODEN FINISHES / Finiture legno



PACKING / Imballo



TECHNICAL DETAILS / Dettagli tecnici



SAFETY, STRENGTH and DURABILITY TESTS  
Prove di sicurezza, resistenza e durata  
EN 1728:2000



## Gliss 930



SEAT Sedile	BACK Schienale	FRAME Telaio	CHROMED Cromato
F01; F04+F09	F01; F04+F09	Ø 10	<b>€ 678,00</b>

For fabrics see page 367  
Per i tessuti si veda a p. 367

PACKING / Imballo



TECHNICAL DETAILS / Dettagli tecnici



## Gliss 940/F



SEAT Sedile	BACK Schienale	FRAME Telaio	BRUSHED S/STEEL Inox satinato	POLISHED S/STEEL Inox lucidato
F01; F04+F09	F01; F04+F09	Ø 400	<b>€ 782,00</b>	<b>€ 795,00</b>

For fabrics see page 367  
Per i tessuti si veda a p. 367

PACKING / Imballo



TECHNICAL DETAILS / Dettagli tecnici



## Gliss 950/F

Gas lift device  
Alzata a gas



SEAT Sedile	BACK Schienale	FRAME Telaio	CHROMED Cromato
F01; F04+F09	F01; F04+F09	Ø 400	<b>€ 824,00</b>

For fabrics see page 367  
Per i tessuti si veda a p. 367

PACKING / Imballo



TECHNICAL DETAILS / Dettagli tecnici

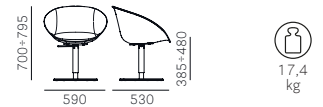

## Gliss 966/2F

Gas lift device  
Alzata a gas



SEAT Sedile	BACK Schienale	FRAME Telaio	WHITE/BLACK POWDER COATED Verniciato bianco/nero	POLISHED ALUMINIUM Alluminio lucidato
F01; F04+F09	F01; F04+F09	Ø 750	<b>€ 770,00</b>	<b>€ 833,00</b>

For fabrics see page 367  
Per i tessuti si veda a p. 367

PACKING / Imballo



TECHNICAL DETAILS / Dettagli tecnici



## Gliss 900/A



SEAT Sedile	BACK Schienale	FRAME Telaio	BLACK POWDER COATED Verniciato nero	CHROMED Cromato
A	A	Ø 16	€ 384,00	€ 384,00
C*	C*		€ 437,00	€ 437,00
E	E		€ 587,00	€ 587,00
G	G		€ 587,00	€ 587,00
H*	H*		€ 445,00	€ 445,00
TC**	TC**		€ 384,00	€ 384,00

\*\*TC = Minimum order 10 pcs each fabric colour. Feasibility to be approved  
TC = Ordine minimo 10 pz per colore/tessuto. Fattibilità da valutare

\*Excluding / Escluso C36+C39, H140+H143

For fabrics see page 367  
Per i tessuti si veda a p. 367

PACKING / Imballo



FABRIC REQUIRED / Fabbisogno tessuto  
On request / A richiesta

TECHNICAL DETAILS / Dettagli tecnici



8,6 kg

## Gliss 904/A

WOOD



SEAT Sedile	BACK Schienale	FRAME Telaio	ASH Frassino	ASH STAINED ON SAMPLE Frassino tinto campione
A	A	FR-N1-AN TC***	€ 468,00	€ 494,00
C*	C*		€ 523,00	€ 548,00
E	E		€ 672,00	€ 697,00
G	G		€ 672,00	€ 697,00
H*	H*		€ 531,00	€ 556,00
TC**	TC**		€ 468,00	€ 494,00

\*\*TC = Minimum order 10 pcs each fabric colour. Feasibility to be approved  
TC = Ordine minimo 10 pz per colore/tessuto. Fattibilità da valutare

\*Excluding / Escluso C36+C39, H140+H143

\*\*\*Steel rod frame under the seat, black powder coated  
Telaio tondino verniciato nero

WOODEN FINISHES / Finiture legno



FR

AN

N1

PACKING / Imballo



FABRIC REQUIRED / Fabbisogno tessuto  
On request / A richiesta

Minimum order q.ty: 20 pcs  
Ordine minimo: 20pz

For fabrics see page 367  
Per i tessuti si veda a p. 367

TECHNICAL DETAILS / Dettagli tecnici



8 kg

SAFETY, STRENGTH and DURABILITY TESTS  
Prove di sicurezza, resistenza e durata  
EN 1728:2000

## Gliss 920+900.8



SEAT Sedile	BACK Schienale	FRAME Telaio	POWDER COATED Verniciato	CHROMED Cromato
A	A	Ø 10	€ 320,00	€ 320,00
C*	C*		€ 361,00	€ 361,00
E	E		€ 493,00	€ 493,00
G	G		€ 493,00	€ 493,00
H*	H*		€ 371,00	€ 371,00

\*Excluding / Escluso C36+C39, H140+H143

For fabrics see page 367  
Per i tessuti si veda a p. 367

PACKING / Imballo



FABRIC REQUIRED / Fabbisogno tessuto  
On request / A richiesta

TECHNICAL DETAILS / Dettagli tecnici



7 kg

SAFETY, STRENGTH and DURABILITY TESTS  
Prove di sicurezza, resistenza e durata  
EN 1022:1998

For colours and finishes see at page 362  
Per colori e finiture vedere da pagina 362

## Gliss 1020



SEAT Sedile	BACK Schienale	FRAME Telaio	CHROMED Cromato
A	A	Ø 10	€ 384,00
C*	C*		€ 437,00
E	E		€ 587,00
G	G		€ 587,00
H*	H*		€ 445,00
TC**	TC**		€ 384,00

\*\*TC = Minimum order 10 pcs each fabric colour. Feasibility to be approved  
TC = Ordine minimo 10 pz per colore/tessuto. Fattibilità da valutare

\*Excluding / Escluso C36+C39, H140+H143

For fabrics see page 367  
Per i tessuti si veda a p. 367

PACKING / Imballo

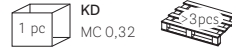

FABRIC REQUIRED / Fabbisogno tessuto

On request / A richiesta

TECHNICAL DETAILS / Dettagli tecnici



SAFETY, STRENGTH and DURABILITY TESTS  
Prove di sicurezza, resistenza e durata  
EN 1728:2000

## Gliss 1040



SEAT Sedile	BACK Schienale	FRAME Telaio	BRUSHED S/STEEL Inox satinato	POLISHED S/STEEL Inox lucidato
A	A	Ø 400	€ 500,00	€ 513,00
C*	C*		€ 545,00	€ 558,00
E	E		€ 703,00	€ 716,00
G	G		€ 703,00	€ 716,00
H*	H*		€ 563,00	€ 575,00
TC**	TC**		€ 500,00	€ 513,00

\*\*TC = Minimum order 10 pcs each fabric colour. Feasibility to be approved  
TC = Ordine minimo 10 pz per colore/tessuto. Fattibilità da valutare

\*Excluding / Escluso C36+C39, H140+H143

For fabrics see page 367  
Per i tessuti si veda a p. 367

PACKING / Imballo



FABRIC REQUIRED / Fabbisogno tessuto

On request / A richiesta

TECHNICAL DETAILS / Dettagli tecnici

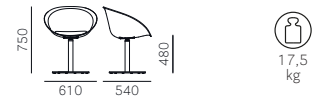

## Gliss 1050

Gas lift device  
Alzata a gas



SEAT Sedile	BACK Schienale	FRAME Telaio	CHROMED Cromato
A	A	Ø 400	€ 509,00
C*	C*		€ 554,00
E	E		€ 712,00
G	G		€ 712,00
H*	H*		€ 571,00
TC**	TC**		€ 509,00

\*\*TC = Minimum order 10 pcs each fabric colour. Feasibility to be approved  
TC = Ordine minimo 10 pz per colore/tessuto. Fattibilità da valutare

\*Excluding / Escluso C36+C39, H140+H143

For fabrics see page 367  
Per i tessuti si veda a p. 367

PACKING / Imballo



FABRIC REQUIRED / Fabbisogno tessuto

On request / A richiesta

TECHNICAL DETAILS / Dettagli tecnici



## Gliss 902



SEAT Sedile	BACK Schienale	FRAME Telaio	WHITE/BLACK POWDER COATED Verniciato bianco/nero	CHROMED Cromato
PC	PC	Ø 11 H650	<p><b>€ 124,00</b></p> <p>Powder coated in the same colour of the shell Verniciato in tinta con la scocca</p>	<p><b>€ 124,00</b></p>

PC FINISHES / Finiture PC

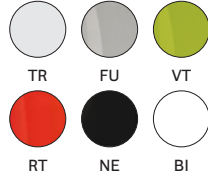

PACKING / Imballo



TECHNICAL DETAILS / Dettagli tecnici

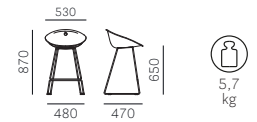

SAFETY, STRENGTH and DURABILITY TESTS  
Prove di sicurezza, resistenza e durata  
EN 1728:2000

## Gliss 906



SEAT Sedile	BACK Schienale	FRAME Telaio	WHITE/BLACK POWDER COATED Verniciato bianco/nero	CHROMED Cromato
PC	PC	Ø 11 H750	<p><b>€ 136,00</b></p> <p>Powder coated in the same colour of the shell Verniciato in tinta con la scocca</p>	<p><b>€ 136,00</b></p>

PC FINISHES / Finiture PC

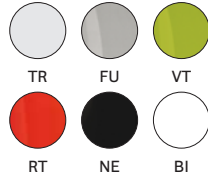

PACKING / Imballo



TECHNICAL DETAILS / Dettagli tecnici

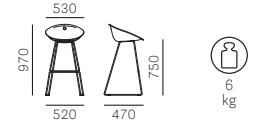

SAFETY, STRENGTH and DURABILITY TESTS  
Prove di sicurezza, resistenza e durata  
EN 1728:2000

## Gliss 970

Gas lift device  
Alzata a gas



SEAT Sedile	BACK Schienale	FRAME Telaio	CHROMED Cromato
PC	PC	Ø 400 H555+815	<p><b>€ 303,00</b></p>

PC FINISHES / Finiture PC

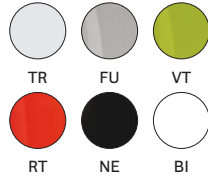

PACKING / Imballo



TECHNICAL DETAILS / Dettagli tecnici

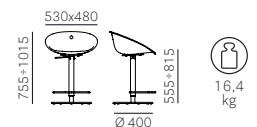

SAFETY, STRENGTH and DURABILITY TESTS  
Prove di sicurezza, resistenza e durata  
EN 1728:2000

## Gliss 975



SEAT Sedile	BACK Schienale	FRAME Telaio	CHROMED Cromato	BRUSHED S/STEEL Inox satinato
PC	PC	Ø 400 H730	€ 260,00	€ 289,00

### PC FINISHES / Finiture PC

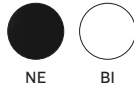

### PACKING / Imballo



### TECHNICAL DETAILS / Dettagli tecnici

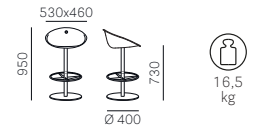

## Gliss 932



SEAT Sedile	BACK Schienale	FRAME Telaio	WHITE/BLACK POWDER COATED Verniciato bianco/nero	CHROMED Cromato
F01; F04+F09	F01; F04+F09	Ø 11 H660	€ 581,00	€ 581,00

### GENUINE LEATHER FINISHES / Finiture cuoio naturale



### PACKING / Imballo



### TECHNICAL DETAILS / Dettagli tecnici

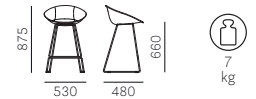

## Gliss 936



SEAT Sedile	BACK Schienale	FRAME Telaio	WHITE/BLACK POWDER COATED Verniciato bianco/nero	CHROMED Cromato
F01; F04+F09	F01; F04+F09	Ø 11 H760	€ 593,00	€ 593,00

### GENUINE LEATHER FINISHES / Finiture cuoio naturale



### PACKING / Imballo



### TECHNICAL DETAILS / Dettagli tecnici

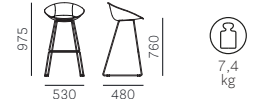

## Gliss 990

Gas lift device  
Alzata a gas



SEAT Sedile	BACK Schienale	FRAME Telaio	CHROMED Cromato
F01; F04+F09	F01; F04+F09	Ø 400 H565+825	<b>€ 781,00</b>

GENUINE LEATHER FINISHES / Finiture cuoio naturale



PACKING / Imballo



TECHNICAL DETAILS / Dettagli tecnici

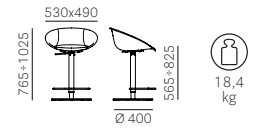

SAFETY, STRENGTH and DURABILITY TESTS  
Prove di sicurezza, resistenza e durata  
EN 1728:2000

## Gliss 912



SEAT Sedile	BACK Schienale	FRAME Telaio	WHITE/BLACK POWDER COATED Verniciato bianco/nero	CHROMED Cromato
A	A		<b>€ 334,00</b>	<b>€ 334,00</b>
C*	C*		<b>€ 378,00</b>	<b>€ 378,00</b>
E	E	Ø 11 H670	<b>€ 527,00</b>	<b>€ 527,00</b>
G	G		<b>€ 527,00</b>	<b>€ 527,00</b>
H*	H*		<b>€ 387,00</b>	<b>€ 387,00</b>
TC**	TC**		<b>€ 334,00</b>	<b>€ 334,00</b>

\*\*TC = Minimum order 10 pcs each fabric colour. Feasibility to be approved  
TC = Ordine minimo 10 pz per colore/tessuto. Fattibilità da valutare

\*Excluding / Escluso C36+C39, H140+H143

For fabrics see page 367  
Per i tessuti si veda a p. 367

PACKING / Imballo



FABRIC REQUIRED / Fabbisogno tessuto  
On request / A richiesta

TECHNICAL DETAILS / Dettagli tecnici

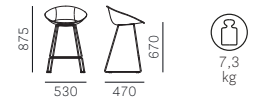

## Gliss 916



SEAT Sedile	BACK Schienale	FRAME Telaio	WHITE/BLACK POWDER COATED Verniciato bianco/nero	CHROMED Cromato
A	A		<b>€ 346,00</b>	<b>€ 346,00</b>
C*	C*		<b>€ 391,00</b>	<b>€ 391,00</b>
E	E	Ø 11 H770	<b>€ 540,00</b>	<b>€ 540,00</b>
G	G		<b>€ 540,00</b>	<b>€ 540,00</b>
H*	H*		<b>€ 400,00</b>	<b>€ 400,00</b>
TC**	TC**		<b>€ 346,00</b>	<b>€ 346,00</b>

\*\*TC = Minimum order 10 pcs each fabric colour. Feasibility to be approved  
TC = Ordine minimo 10 pz per colore/tessuto. Fattibilità da valutare

\*Excluding / Escluso C36+C39, H140+H143

For fabrics see page 367  
Per i tessuti si veda a p. 367

PACKING / Imballo



FABRIC REQUIRED / Fabbisogno tessuto  
On request / A richiesta

TECHNICAL DETAILS / Dettagli tecnici





## Gliss 980

Gas lift device  
Alzata a gas



SEAT Sedile	BACK Schienale	FRAME Telaio	CHROMED Cromato
A	A	Ø 400 H565+825	€ 496,00
C*	C*		€ 552,00
E	E		€ 690,00
G	G		€ 690,00
H*	H*		€ 549,00
TC**	TC**		€ 496,00

\*\*TC = Minimum order 10 pcs each fabric colour. Feasibility to be approved  
TC = Ordine minimo 10 pz per colore/tessuto. Fattibilità da valutare

\*Excluding / Escluso C36+C39, H140+H143

For fabrics see page 367  
Per i tessuti si veda a p. 367

PACKING / Imballo



FABRIC REQUIRED / Fabbisogno tessuto

On request / A richiesta

TECHNICAL DETAILS / Dettagli tecnici

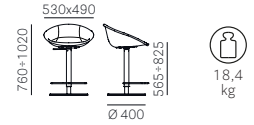

SAFETY, STRENGTH and DURABILITY TESTS  
Prove di sicurezza, resistenza e durata  
EN 1728:2000

## Gliss 985



SEAT Sedile	BACK Schienale	FRAME Telaio	CHROMED Cromato	BRUSHED S/STEEL Inox satinato
A	A	Ø 400 H740	€ 476,00	€ 507,00
C*	C*		€ 530,00	€ 560,00
E	E		€ 670,00	€ 701,00
G	G		€ 670,00	€ 701,00
H*	H*		€ 529,00	€ 559,00
TC**	TC**		€ 476,00	€ 507,00

\*\*TC = Minimum order 10 pcs each fabric colour. Feasibility to be approved  
TC = Ordine minimo 10 pz per colore/tessuto. Fattibilità da valutare

\*Excluding / Escluso C36+C39, H140+H143

For fabrics see page 367  
Per i tessuti si veda a p. 367

PACKING / Imballo



FABRIC REQUIRED / Fabbisogno tessuto

On request / A richiesta

TECHNICAL DETAILS / Dettagli tecnici

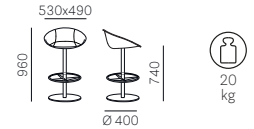

## Gliss 340

LOUNGE



SEAT Sedile	BACK Schienale	FRAME Telaio	POWDER COATED Verniciato	CHROMED Cromato
TP	TP	Ø 12	€ 157,00	€ 157,00

TP FINISHES / Finiture TP



SAFETY, STRENGTH and DURABILITY TESTS  
Prove di sicurezza, resistenza e durata  
EN 1728:2000

PACKING / Imballo



TECHNICAL DETAILS / Dettagli tecnici

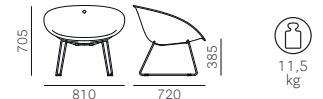

For colours and finishes see at page 362  
Per colori e finiture vedere da pagina 362



## Gliss 350

SWING



SEAT Sedile	BACK Schienale	FRAME Telaio	CHROMED Cromato
TP	TP	Ø 12	€ 257,00

TP FINISHES / Finiture TP



WOODEN FINISHES / Finiture legno



PACKING / Imballo



TECHNICAL DETAILS / Dettagli tecnici

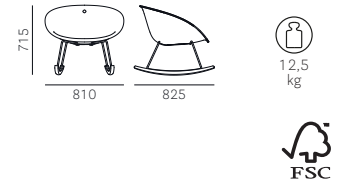

## Gliss 360

LOUNGE



SEAT Sedile	BACK Schienale	POWDER COATED Verniciato	POLISHED ALUMINIUM Alluminio lucidato
TP	TP	€ 286,00	€ 347,00

TP FINISHES / Finiture TP



PACKING / Imballo



TECHNICAL DETAILS / Dettagli tecnici

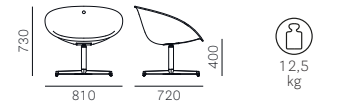

## Gliss 340/3

Fabric covering only  
Solo vestina



SEAT Sedile	BACK Schienale	FABRIC Tessuto
A	A	€ 248,00
C*	C*	€ 294,00
E	E	€ 441,00
G	G	€ 441,00
H*	H*	€ 305,00

For technopolymer shell only  
Solo per scocca tecnopolimero

\*Excluding / Escluso C36+C39, H140+H143

For fabrics see page 367  
Per i tessuti si veda a p. 367

PACKING / Imballo



TECHNICAL DETAILS / Dettagli tecnici



For colours and finishes see at page 362  
Per colori e finiture vedere da pagina 362

# Gliss 341

LOUNGE



SEAT Sedile	BACK Schienale	FRAME Telaio	POWDER COATED Verniciato	CHROMED Cromato
F01; F04+F09	F01; F04+F09	Ø 12	€ 1.055,00	€ 1.055,00

For fabrics see page 367  
Per i tessuti si veda a p. 367

PACKING / Imballo



TECHNICAL DETAILS / Dettagli tecnici

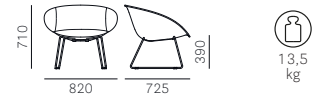

SAFETY, STRENGTH and DURABILITY TESTS  
Prove di sicurezza, resistenza e durata  
EN 1728:2000

# Gliss 351

SWING



SEAT Sedile	BACK Schienale	FRAME Telaio	CHROMED Cromato
F01; F04+F09	F01; F04+F09	Ø 12	€ 1.147,00

For fabrics see page 367  
Per i tessuti si veda a p. 367

WOODEN FINISHES / Finiture legno



FR

PACKING / Imballo



TECHNICAL DETAILS / Dettagli tecnici



# Gliss 361

LOUNGE



SEAT Sedile	BACK Schienale	FRAME Telaio	POWDER COATED Verniciato	POLISHED ALUMINIUM Alluminio lucidato
F01; F04+F09	F01; F04+F09	Ø 820	€ 1.192,00	€ 1.255,00

For fabrics see page 367  
Per i tessuti si veda a p. 367

PACKING / Imballo



TECHNICAL DETAILS / Dettagli tecnici

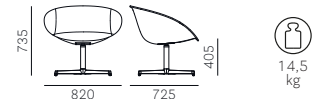

For colours and finishes see at page 362  
Per colori e finiture vedere da pagina 362

## Gliss 943



SEAT Sedile	BACK Schienale	FRAME Telaio
TP	TP	2x Ø 450

**BRUSHED S/STEEL**  
Inox satinato

**€ 619,00**

TP FINISHES / Finiture TP



PACKING / Imballo



TECHNICAL DETAILS / Dettagli tecnici



## Gliss 944



SEAT Sedile	BACK Schienale	FRAME Telaio
TP	TP	2x Ø 450

**BRUSHED S/STEEL**  
Inox satinato

**€ 797,00**

TP FINISHES / Finiture TP



PACKING / Imballo



TECHNICAL DETAILS / Dettagli tecnici

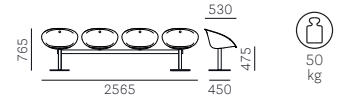

## Gliss 945



SEAT Sedile	BACK Schienale	FRAME Telaio
TP	TP	2x Ø 450

**BRUSHED S/STEEL**  
Inox satinato

**€ 789,00**

TP FINISHES / Finiture TP



TOP FINISHES / Finiture ripiano



406\_0020

PACKING / Imballo



TECHNICAL DETAILS / Dettagli tecnici



## Gossip 621RM



recycled polypropylene



SEAT Sedile	BACK Schienale	FRAME Telaio	POLYPROPYLENE Polipropilene	
PPL	PPL	PPL		€ 64,00

PPL FINISHES / Finiture PPL



RG

PACKING / Imballo



MC 0,485

TECHNICAL DETAILS / Dettagli tecnici

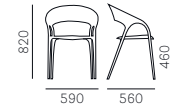

SAFETY, STRENGTH and DURABILITY TESTS  
Prove di sicurezza, resistenza e durata  
EN 1728:2012+AC2013  
EN 581-1:2017  
EN 581-2:2015+AC:2016



## Gossip 621



SEAT Sedile	BACK Schienale	FRAME Telaio	POLYPROPYLENE Polipropilene	
PPL	PPL	PPL		€ 64,00

PPL FINISHES / Finiture PPL



NE

SA

VE

PACKING / Imballo



MC 0,485

TECHNICAL DETAILS / Dettagli tecnici

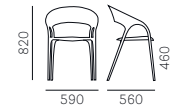

SAFETY, STRENGTH and DURABILITY TESTS  
Prove di sicurezza, resistenza e durata  
EN 1728:2012+AC2013  
EN 581-1:2017  
EN 581-2:2015+AC:2016



## Grace 410



SEAT Sedile	BACK Schienale	FRAME Telaio	POWDER COATED Verniciato	SILVER POWDER COATED Verniciato alluminio	CHROMED Cromato	BRUSHED S/STEEL Inox satinato
PPL	PPL	Ø 16	€ 90,00 FRAME/TELAIO* White/Bianco Black/Nero Orange/Arancio	€ 95,00	€ 90,00	€ 132,00 AISI 316L

FRAME/TELAIO\*  
Powder coated in the same colour of the shell / Verniciato in tinta con la scocca

PPL FINISHES / Finiture PPL



BI

NE

RO

AR

VE

PACKING / Imballo



MC 0,38

TECHNICAL DETAILS / Dettagli tecnici

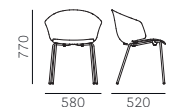

For colours and finishes see at page 362  
Per colori e finiture vedere da pagina 362



## Grace 411



SEAT Sedile	BACK Schienale	FRAME Telaio	POWDER COATED Verniciato	CHROMED Cromato
PPL	PPL	Ø 11	<b>€ 84,00</b> FRAME/TELAIO* White/Bianco Black/Nero Orange/Arancio	<b>€ 84,00</b>

FRAME/TELAIO\*  
Powder coated in the same colour of the shell / Verniciato in tinta con la scocca

PPL FINISHES / Finiture PPL



PACKING / Imballo



TECHNICAL DETAILS / Dettagli tecnici

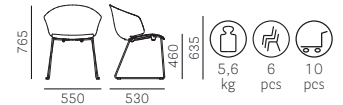

SAFETY, STRENGTH and DURABILITY TESTS  
Prove di sicurezza, resistenza e durata  
EN 1728:2000



## Happy 490



SEAT Sedile	FRAME Telaio	POLYPROPYLENE Polipropilene
PPL	PPL H750	<b>€ 72,00</b>

PPL FINISHES / Finiture PPL



PACKING / Imballo



TECHNICAL DETAILS / Dettagli tecnici



SAFETY, STRENGTH and DURABILITY TESTS  
Prove di sicurezza, resistenza e durata  
EN 1728:2000



## Happy 491



SEAT Sedile	FRAME Telaio	POLYPROPYLENE Polipropilene
PPL	PPL H450	<b>€ 49,00</b>

PPL FINISHES / Finiture PPL



PACKING / Imballo



TECHNICAL DETAILS / Dettagli tecnici



For colours and finishes see at page 362  
Per colori e finiture vedere da pagina 362



## Héra 2865



SEAT Sedile	BACK Schienale	FRAME Telaio	ASH Frassino	ASH STAINED ON SAMPLE Frassino tinto campione	WALNUT (N) Noce
C*			€ 688,00	€ 710,00	€ 758,00
D40+D44 D120+D123			€ 708,00	€ 730,00	€ 778,00
E			€ 740,00	€ 762,00	€ 810,00
G	FR-AN-N	FR-AN-N	€ 740,00	€ 762,00	€ 810,00
H			€ 694,00	€ 717,00	€ 764,00
N	TC	TC	€ 754,00	€ 777,00	€ 824,00
P*			€ 853,00	€ 875,00	€ 923,00
TC**			€ 671,00	€ 693,00	€ 741,00
CL**			€ 676,00	€ 699,00	€ 746,00

\*\*TC/CL = Minimum order 10 pcs each fabric colour  
TC/CL = Ordine minimo 10 pz per colore/tessuto

\*Excluding / Escluso C36+C39, PBS-PCO-PMS-PVE

## FINISHES / Finiture



SAFETY, STRENGTH and DURABILITY TESTS  
Prove di sicurezza, resistenza e durata  
EN 1728:2012+AC2013  
EN 16139:2013 level 2

For fabrics see page 367  
Per i tessuti si veda a p. 367

## PACKING / Imballo



## FABRIC REQUIRED / Fabbisogno tessuto

1pc: Lin Mtrs 0,60 (h 1,40)  
fabric and simil leather / tessuto e finta pelle  
1pc: Square Mtrs 1,20 mid-grain leather / pelle mezzo fiore

## TECHNICAL DETAILS / Dettagli tecnici



## Héra 2869

LOUNGE



SEAT Sedile	BACK Schienale	FRAME Telaio	ASH Frassino	ASH * Frassino	ASH STAINED ON SAMPLE Frassino tinto campione
C**			€ 1.750,00	€ 1.750,00	€ 1.772,00
D40+D44 D120+D123	N3	N3	€ 1.770,00	€ 1.770,00	€ 1.792,00
E			€ 1.820,00	€ 1.820,00	€ 1.842,00
G	BI-GC-AN- BL2-AZ1-	BI-GC-AN- BL2-AZ1-	€ 1.820,00	€ 1.820,00	€ 1.842,00
H	VE2-VE1-R-	VE2-VE1-R-	€ 1.760,00	€ 1.760,00	€ 1.782,00
N	B-RA- MO-MC	B-RA- MO-MC	€ 1.840,00	€ 1.840,00	€ 1.862,00
P**			€ 1.960,00	€ 1.960,00	€ 1.982,00
TC***	TC	TC	€ 1.720,00	€ 1.720,00	€ 1.742,00
CL***			€ 1.726,00	€ 1.726,00	€ 1.748,00

\*\*\*TC/CL = Minimum order 10 pcs each fabric colour  
TC/CL = Ordine minimo 10 pz per colore/tessuto

\*\*Excluding / Escluso C36+C39, PBS-PCO-PMS-PVE

## FINISHES / Finiture

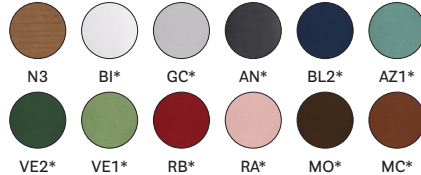

For fabrics see page 367  
Per i tessuti si veda a p. 367

## PACKING / Imballo



## FABRIC REQUIRED / Fabbisogno tessuto

1pc: Lin Mtrs 0,90 (h 1,40)  
fabric and simil leather / tessuto e finta pelle  
1pc: Square Mtrs 1,45 mid-grain leather / pelle mezzo fiore

## TECHNICAL DETAILS / Dettagli tecnici



## Host 200

Sofa unit  
Divano

SEAT Sedile	BACK Schienale	FRAME Telaio	POWDER COATED Verniciato	CHROMED Cromato
A	A		€ 736,00	€ 718,00
C*	C*		€ 805,00	€ 787,00
D40+D44	D40+D44		€ 883,00	€ 865,00
E	E	Ø 16	€ 1.031,00	€ 1.013,00
G	G		€ 1.031,00	€ 1.013,00
H*	H*		€ 822,00	€ 804,00
TC**	TC**		€ 736,00	€ 718,00

\*\*TC = Minimum order 10 pcs each fabric colour  
TC = Ordine minimo 10 pz per colore/tessuto

\*Excluding / Escluso C36+C39, C90+C95, H140+H143

Couple of linking devices included  
Inclusa una coppia di ganci di collegamento  
(Item / Art. 200/G\_NE)

For fabrics see page 367  
Per i tessuti si veda a p. 367

PACKING / Imballo



FABRIC REQUIRED / Fabbisogno tessuto  
1pc: Lin Mtrs 2,60 (h 1,40)

TECHNICAL DETAILS / Dettagli tecnici

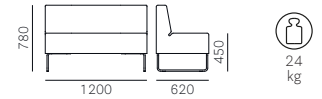

## Host 201

Single seat unit  
Seduta singola

SEAT Sedile	BACK Schienale	FRAME Telaio	POWDER COATED Verniciato	CHROMED Cromato
A	A		€ 456,00	€ 438,00
C*	C*		€ 498,00	€ 480,00
D40+D44	D40+D44		€ 554,00	€ 536,00
E	E	Ø 16	€ 638,00	€ 620,00
G	G		€ 638,00	€ 620,00
H*	H*		€ 509,00	€ 491,00
TC**	TC**		€ 456,00	€ 438,00

\*\*TC = Minimum order 10 pcs each fabric colour  
TC = Ordine minimo 10 pz per colore/tessuto

\*Excluding / Escluso C36+C39, C90+C95, H140+H143

Couple of linking devices included  
Inclusa una coppia di ganci di collegamento  
(Item / Art. 200/G\_NE)

For fabrics see page 367  
Per i tessuti si veda a p. 367

PACKING / Imballo



FABRIC REQUIRED / Fabbisogno tessuto  
1pc: Lin Mtrs 1,90 (h 1,40)

TECHNICAL DETAILS / Dettagli tecnici

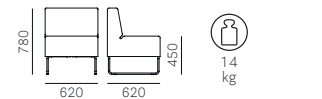

## Host 202

Corner unit  
Angolare

SEAT Sedile	BACK Schienale	FRAME Telaio	POWDER COATED Verniciato	CHROMED Cromato
A	A		€ 599,00	€ 581,00
C*	C*		€ 652,00	€ 634,00
D40+D44	D40+D44		€ 712,00	€ 694,00
E	E	Ø 16	€ 826,00	€ 808,00
G	G		€ 826,00	€ 808,00
H*	H*		€ 665,00	€ 647,00
TC**	TC**		€ 599,00	€ 581,00

\*\*TC = Minimum order 10 pcs each fabric colour  
TC = Ordine minimo 10 pz per colore/tessuto

\*Excluding / Escluso C36+C39, C90+C95, H140+H143

Couple of linking devices included  
Inclusa una coppia di ganci di collegamento  
(Item / Art. 200/G\_NE)

For fabrics see page 367  
Per i tessuti si veda a p. 367

PACKING / Imballo



FABRIC REQUIRED / Fabbisogno tessuto  
1pc: Lin Mtrs 2,00 (h 1,40)

TECHNICAL DETAILS / Dettagli tecnici

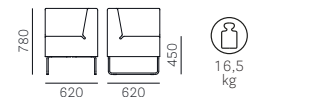

For colours and finishes see at page 362  
Per colori e finiture vedere da pagina 362



## Host 203

Pouf



SEAT Sedile	FRAME Telaio	POWDER COATED Verniciato	CHROMED Cromato
A	Ø 16	€ 376,00	€ 358,00
C*		€ 400,00	€ 382,00
D40÷D44		€ 435,00	€ 417,00
E		€ 478,00	€ 460,00
G		€ 478,00	€ 460,00
H*		€ 406,00	€ 388,00
TC**		€ 376,00	€ 358,00

\*\*TC = Minimum order 10 pcs each fabric colour  
TC = Ordine minimo 10 pz per colore/tessuto

\*Excluding / Escluso C36+C39, C90+C95, H140+H143

Couple of linking devices included  
Inclusa una coppia di ganci di collegamento  
(Item / Art. 200/G\_NE)

For fabrics see page 367  
Per i tessuti si veda a p. 367

PACKING / Imballo



FABRIC REQUIRED / Fabbisogno tessuto  
1pc: Lin Mtrs 1,20 (h 1,40)

TECHNICAL DETAILS / Dettagli tecnici



## Host 220

Sofa unit  
Divano

SEAT Sedile	BACK Schienale	FRAME Telaio	POWDER COATED Verniciato	CHROMED Cromato
A	A	25x25	€ 826,00	€ 808,00
C*	C*		€ 895,00	€ 877,00
D40÷D44	D40÷D44		€ 973,00	€ 955,00
E	E		€ 1.120,00	€ 1.102,00
G	G		€ 1.120,00	€ 1.102,00
H*	H*		€ 912,00	€ 894,00
TC**	TC**		€ 826,00	€ 808,00

\*\*TC = Minimum order 10 pcs each fabric colour  
TC = Ordine minimo 10 pz per colore/tessuto

\*Excluding / Escluso C36+C39, C90+C95, H140+H143

For fabrics see page 367  
Per i tessuti si veda a p. 367

PACKING / Imballo



FABRIC REQUIRED / Fabbisogno tessuto  
1pc: Lin Mtrs 2,60 (h 1,40)

TECHNICAL DETAILS / Dettagli tecnici

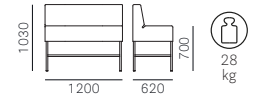

## Host 221

Single seat unit  
Seduta singola

SEAT Sedile	BACK Schienale	FRAME Telaio	POWDER COATED Verniciato	CHROMED Cromato
A	A	25x25	€ 492,00	€ 474,00
C*	C*		€ 534,00	€ 516,00
D40÷D44	D40÷D44		€ 590,00	€ 572,00
E	E		€ 674,00	€ 656,00
G	G		€ 674,00	€ 656,00
H*	H*		€ 545,00	€ 527,00
TC**	TC**		€ 492,00	€ 474,00

\*\*TC = Minimum order 10 pcs each fabric colour  
TC = Ordine minimo 10 pz per colore/tessuto

\*Excluding / Escluso C36+C39, C90+C95, H140+H143

For fabrics see page 367  
Per i tessuti si veda a p. 367

PACKING / Imballo



FABRIC REQUIRED / Fabbisogno tessuto  
1pc: Lin Mtrs 1,90 (h 1,40)

TECHNICAL DETAILS / Dettagli tecnici



For colours and finishes see at page 362  
Per colori e finiture vedere da pagina 362

## Host 222

Corner unit  
Angolare



SEAT Sedile	BACK Schienale	FRAME Telaio	POWDER COATED Verniciato	CHROMED Cromato
A	A		€ 635,00	€ 617,00
C*	C*		€ 688,00	€ 670,00
D40+D44	D40+D44		€ 748,00	€ 730,00
E	E	25x25	€ 862,00	€ 844,00
G	G		€ 862,00	€ 844,00
H*	H*		€ 701,00	€ 683,00
TC**	TC**		€ 635,00	€ 617,00

\*\*TC = Minimum order 10 pcs each fabric colour  
TC = Ordine minimo 10 pz per colore/tessuto

\*Excluding / Escluso C36+C39, C90+C95, H140+H143

For fabrics see page 367  
Per i tessuti si veda a p. 367

PACKING / Imballo



FABRIC REQUIRED / Fabbisogno tessuto  
1pc: Lin Mtrs 2,00 (h 1,40)

TECHNICAL DETAILS / Dettagli tecnici

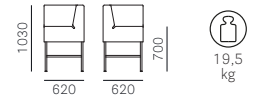

## Host 223

Pouf



SEAT Sedile	FRAME Telaio	POWDER COATED Verniciato	CHROMED Cromato
A		€ 412,00	€ 394,00
C*		€ 436,00	€ 418,00
D40+D44		€ 471,00	€ 453,00
E	25x25	€ 514,00	€ 496,00
G		€ 514,00	€ 496,00
H*		€ 442,00	€ 424,00
TC**		€ 412,00	€ 394,00

\*\*TC = Minimum order 10 pcs each fabric colour  
TC = Ordine minimo 10 pz per colore/tessuto

\*Excluding / Escluso C36+C39, C90+C95, H140+H143

For fabrics see page 367  
Per i tessuti si veda a p. 367

PACKING / Imballo



FABRIC REQUIRED / Fabbisogno tessuto  
1pc: Lin Mtrs 1,20 (h 1,40)

TECHNICAL DETAILS / Dettagli tecnici



## Host lounge 790



SEAT Sedile	BACK Schienale	FRAME Telaio	BRUSHED S/STEEL Inox satinato
PET	PET	Ø 16	€ 292,00 AISI 316

Couple of linking devices included / Inclusa una coppia di ganci di collegamento  
(Item / Art. 790/G\_NE)

PET FINISHES / Finiture PET

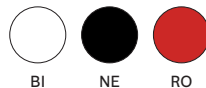

PACKING / Imballo



TECHNICAL DETAILS / Dettagli tecnici



For colours and finishes see at page 362  
Per colori e finiture vedere da pagina 362

## Host lounge 792



SEAT Sedile	FRAME Telaio	BRUSHED S/STEEL Inox satinato
PET	Ø 16	€ 259,00 AISI 316

Couple of linking devices included / Inclusa una coppia di ganci di collegamento (Item / Art. 790/G\_NE)

PET FINISHES / Finiture PET

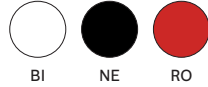

PACKING / Imballo



TECHNICAL DETAILS / Dettagli tecnici



## Host lounge 791



SEAT Sedile	BACK Schienale	FRAME Telaio	CHROMED Cromato
A	A		€ 471,00
H *	H *	Ø 16	€ 561,00
TC **	TC **		€ 471,00

\*\*TC = Minimum order 10 pcs each fabric colour  
TC = Ordine minimo 10 pz per colore/tessuto

\*Excluding / Escluso H140+H143

Couple of linking devices included  
Inclusa una coppia di ganci di collegamento (Item / Art. 790/G\_NE)

For fabrics see page 367  
Per i tessuti si veda a p. 367

PACKING / Imballo



TECHNICAL DETAILS / Dettagli tecnici

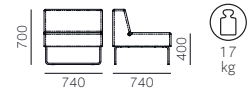

FABRIC REQUIRED / Fabbisogno tessuto  
On request / A richiesta

## Host lounge 793



SEAT Sedile	FRAME Telaio	CHROMED Cromato
A		€ 361,00
H *	Ø 16	€ 429,00
TC **		€ 361,00

\*\*TC = Minimum order 10 pcs each fabric colour  
TC = Ordine minimo 10 pz per colore/tessuto

\*Excluding / Escluso H140+H143

Couple of linking devices included  
Inclusa una coppia di ganci di collegamento (Item / Art. 790/G\_NE)

For fabrics see page 367  
Per i tessuti si veda a p. 367

PACKING / Imballo



TECHNICAL DETAILS / Dettagli tecnici

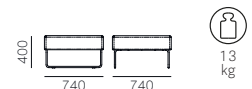

FABRIC REQUIRED / Fabbisogno tessuto  
On request / A richiesta

## HX 4445F



SEAT Sedile	FRAME Telaio	BRUSHED S/STEEL Inox satinato
Frame only / Solo telaio		€ 224,00
A		€ 271,00
C*		€ 286,00
G		€ 316,00
H*	400x400	€ 285,00
P*		€ 328,00
TC**		€ 271,00
CL**		€ 277,00
PG		€ 243,00

\*\*TC/CL = Minimum order 10 pcs each fabric colour  
TC/CL = Ordine minimo 10 pz per colore/tessuto

\*Excluding / Escluso C36+C39, H140+H143, PBS-PCO-PMS-PVE

For fabrics see page 367  
Per i tessuti si veda a p. 367

PACKING / Imballo



FABRIC REQUIRED / Fabbisogno tessuto  
1pc: Lin Mtrs 0,40 (h 1,40)

TECHNICAL DETAILS / Dettagli tecnici

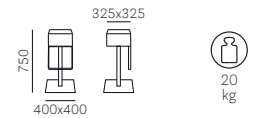

## HX 4445G



SEAT Sedile	FRAME Telaio	BRUSHED S/STEEL Inox satinato
Frame only / Solo telaio		€ 257,00
A		€ 304,00
C*		€ 319,00
G		€ 349,00
H*	400x400	€ 318,00
P*		€ 361,00
TC**		€ 304,00
CL**		€ 310,00
PG		€ 276,00

\*\*TC/CL = Minimum order 10 pcs each fabric colour  
TC/CL = Ordine minimo 10 pz per colore/tessuto

\*Excluding / Escluso C36+C39, H140+H143, PBS-PCO-PMS-PVE

For fabrics see page 367  
Per i tessuti si veda a p. 367

PACKING / Imballo



FABRIC REQUIRED / Fabbisogno tessuto  
1pc: Lin Mtrs 0,40 (h 1,40)

TECHNICAL DETAILS / Dettagli tecnici

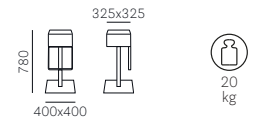

## HX 4446



SEAT Sedile	FRAME Telaio	BLACK POWDER COATED Verniciato nero	POWDER COATED Verniciato	BRUSHED S/STEEL Inox satinato
Frame only / Solo telaio		€ 135,00	€ 141,00	€ 233,00
A		€ 183,00	€ 188,00	€ 280,00
C*		€ 197,00	€ 203,00	€ 295,00
G		€ 227,00	€ 233,00	€ 325,00
H*	400x400	€ 196,00	€ 202,00	€ 294,00
P*		€ 239,00	€ 245,00	€ 337,00
TC**		€ 183,00	€ 188,00	€ 280,00
CL**		€ 188,00	€ 194,00	€ 286,00
PG		€ 154,00	€ 160,00	€ 252,00

\*\*TC/CL = Minimum order 10 pcs each fabric colour  
TC/CL = Ordine minimo 10 pz per colore/tessuto

\*Excluding / Escluso C36+C39, H140+H143, PBS-PCO-PMS-PVE

For fabrics see page 367  
Per i tessuti si veda a p. 367

PACKING / Imballo



FABRIC REQUIRED / Fabbisogno tessuto  
1pc: Lin Mtrs 0,40 (h 1,40)

TECHNICAL DETAILS / Dettagli tecnici

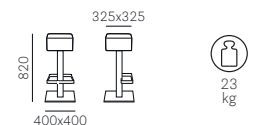

For colours and finishes see at page 362  
Per colori e finiture vedere da pagina 362

## HX 4448



SEAT Sedile	BACK Schienale	FRAME Telaio	BLACK POWDER COATED Verniciato nero	POWDER COATED Verniciato
Frame only / Solo telaio	Frame only / Solo telaio	400x400	€ 191,00	€ 197,00
A	A		€ 272,00	€ 278,00
C*	C*		€ 289,00	€ 294,00
G	G		€ 338,00	€ 343,00
H*	H*		€ 293,00	€ 299,00
P*	P*		€ 357,00	€ 363,00
TC**	TC**		€ 272,00	€ 278,00
CL**	CL**		€ 278,00	€ 283,00
PG	PG		€ 227,00	€ 233,00

\*\*TC/CL = Minimum order 10 pcs each fabric colour  
TC/CL = Ordine minimo 10 pz per colore/tessuto

\*Excluding / Escluso C36+C39, H140+H143, PBS-PCO-PMS-PVE

For fabrics see page 367  
Per i tessuti si veda a p. 367

## PACKING / Imballo



FABRIC REQUIRED / Fabbisogno tessuto  
1pc: Lin Mtrs 0,56 (h 1,40)

## TECHNICAL DETAILS / Dettagli tecnici

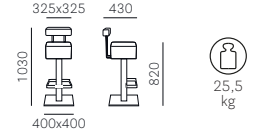

## HXL 4449



SEAT Sedile	BACK Schienale	FRAME Telaio	BLACK POWDER COATED Verniciato nero	POWDER COATED Verniciato	BRUSHED S/STEEL Inox satinato
A	A	400x400	€ 338,00	€ 344,00	€ 436,00
C*	C*		€ 364,00	€ 370,00	€ 461,00
G	G		€ 429,00	€ 435,00	€ 527,00
H*	H*		€ 369,00	€ 374,00	€ 466,00
P*	P*		€ 464,00	€ 470,00	€ 562,00
TC**	TC**		€ 338,00	€ 344,00	€ 436,00
CL**	CL**		€ 344,00	€ 350,00	€ 441,00
PG	PG		€ 259,00	€ 265,00	€ 356,00

\*\*TC/CL = Minimum order 10 pcs each fabric colour  
TC/CL = Ordine minimo 10 pz per colore/tessuto

\*Excluding / Escluso C36+C39, H140+H143, PBS-PCO-PMS-PVE

For fabrics see page 367  
Per i tessuti si veda a p. 367

## PACKING / Imballo



FABRIC REQUIRED / Fabbisogno tessuto  
1pc: Lin Mtrs 1,00 (h 1,40)

## TECHNICAL DETAILS / Dettagli tecnici

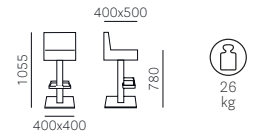

## Ice 800



SEAT Sedile	BACK Schienale	FRAME Telaio
PPL	PPL	Ø 28

**ANODIZED ALUMINIUM**  
Alluminio anodizzato

€ 57,00

PPL FINISHES / Finiture PPL

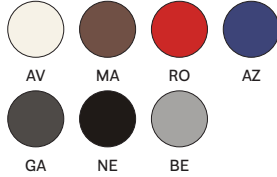

**SAFETY, STRENGTH and DURABILITY TESTS**  
Prove di sicurezza, resistenza e durata  
EN 1728:2000

PACKING / Imballo



TECHNICAL DETAILS / Dettagli tecnici

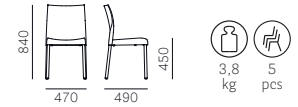

## Ice 800/CL1

Fire retardant version  
Versione ignifuga



SEAT Sedile	BACK Schienale	FRAME Telaio
PPL	PPL	Ø 28

**ANODIZED ALUMINIUM**  
Alluminio anodizzato

€ 81,00

Minimum order 100 pcs each colour  
Ordine minimo 100 pz per colore

PPL FINISHES / Finiture PPL



**SAFETY, STRENGTH and DURABILITY TESTS**  
Prove di sicurezza, resistenza e durata  
EN 1728:2000

PACKING / Imballo



TECHNICAL DETAILS / Dettagli tecnici

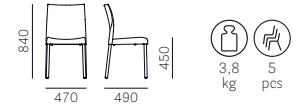

## Ice 850



SEAT Sedile	BACK Schienale	FRAME Telaio
PPL	PPL	Ø 28

**ANODIZED ALUMINIUM**  
Alluminio anodizzato

€ 83,00

PPL FINISHES / Finiture PPL

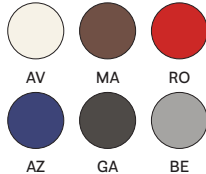

**SAFETY, STRENGTH and DURABILITY TESTS**  
Prove di sicurezza, resistenza e durata  
EN 1728:2000

PACKING / Imballo



TECHNICAL DETAILS / Dettagli tecnici

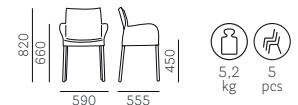

## Ice 850/CL1

Fire retardant version  
Versione ignifuga



SEAT Sedile	BACK Schienale	FRAME Telaio	ANODIZED ALUMINIUM Alluminio anodizzato
PPL	PPL	Ø 28	<b>€ 110,00</b>

Minimum order 300 pcs each colour  
Ordine minimo 300 pz per colore

PPL FINISHES / Finiture PPL



**SAFETY, STRENGTH and DURABILITY TESTS**  
Prove di sicurezza, resistenza e durata  
EN 1728:2000

PACKING / Imballo



TECHNICAL DETAILS / Dettagli tecnici

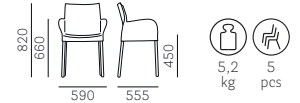

## Ice 840

Linking device  
Gancio di collegamento



FRAME Telaio	NYLON Nylon
NY	<b>€ 8,00</b> For ICE chair and armchair Per sedia e poltrona ICE

PACKING / Imballo



TECHNICAL DETAILS / Dettagli tecnici

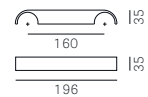

## Ikon 862

LOW STOOL



SEAT Sedile	FRAME Telaio	POLYPROPYLENE Polipropilene
C36+C39 C83+C89; C100+C101 C110+C122 C210+C217	PPL	<b>€ 226,00</b>
D40+D44		<b>€ 242,00</b>
G*		<b>€ 264,00</b>
H60		<b>€ 231,00</b>
H120+H127 TC**		<b>€ 209,00</b>

\*\*TC = Minimum order 10 pcs each fabric colour  
TC = Ordine minimo 10 pz per colore/tessuto

\*Excluding / Escluso G180+G185, G230+G239

PPL FINISHES / Finiture PPL

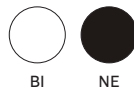

For fabrics see page 367  
Per i tessuti si veda a p. 367

PACKING / Imballo



FABRIC REQUIRED / Fabbisogno tessuto  
1 pc: Lin Mtrs 0,48 (h 1,40)

TECHNICAL DETAILS / Dettagli tecnici

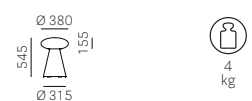

## Ikon Bench B863\_1L

Single linear unit  
Lineare singola



TOP Ripiano	FRAME Telaio	PRICE Prezzo
159x38CFP BIANCO	BI	€ 433,00
159x38COP NERO-247-263	NE-SA-GC	€ 360,00

Floor fixing kit (for each single base): surcharge € 77,00 (item B863\_FIX)  
Kit di fissaggio a terra per singola base: supplemento € 77,00 (art. B863\_FIX)

PPL FINISHES / Finiture PPL

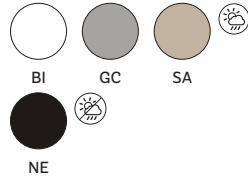

PACKING / Imballo



TECHNICAL DETAILS / Dettagli tecnici

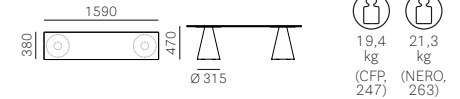

## Ikon Bench B863\_1C

Single curved unit  
Curva singola



TOP Ripiano	FRAME Telaio	PRICE Prezzo
R140x38CFP BIANCO	BI	€ 804,00
R140x38COP NERO-247-263	NE-SA-GC	€ 662,00

Floor fixing kit (for each single base): surcharge € 77,00 (item B863\_FIX)  
Kit di fissaggio a terra per singola base: supplemento € 77,00 (art. B863\_FIX)

PPL FINISHES / Finiture PPL

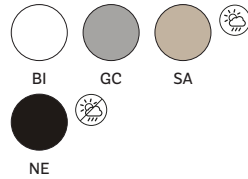

PACKING / Imballo



TECHNICAL DETAILS / Dettagli tecnici

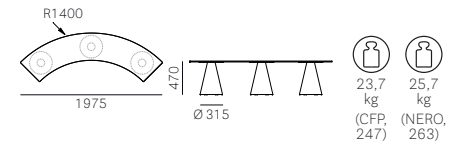

## Ikon Bench B863.4

For single linear unit  
Per moduli lineari

Cushion only  
Solo cuscino



SEAT Sedile	PRICE Prezzo
A	€ 94,00
C	€ 112,00
G	€ 167,00
H *	€ 114,00

\*Excluding / Escluso H140+H143

Price for single cushion  
Prezzo per singolo cuscino

For fabrics see page 367  
Per i tessuti si veda a p. 367

PACKING / Imballo



TECHNICAL DETAILS / Dettagli tecnici





## Examples of IKON Bench combinations

Esempi di configurazioni IKON Bench

### B863\_1L

BI € 433,00  
NE/SA/GC € 360,00

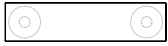

### B863\_2L

BI € 772,00  
NE/SA/GC € 626,00

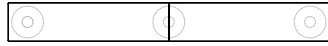

### B863\_3L

BI € 1.110,00  
NE/SA/GC € 893,00

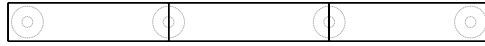

### B863\_4L

BI € 1.449,00  
NE/SA/GC € 1.159,00

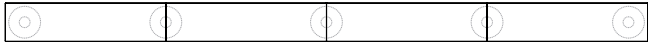

### B863\_4C

BI € 2.935,00  
NE/SA/GC € 2.364,00

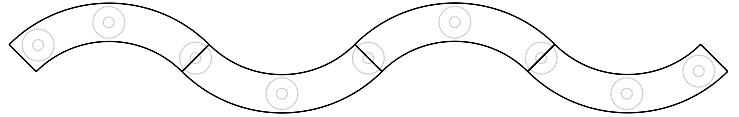

### B863\_1C

BI € 804,00  
NE/SA/GC € 662,00

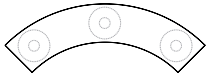

### B863\_2C

BI € 1.515,00  
NE/SA/GC € 1.229,00

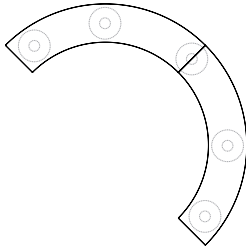

### B863\_3C

BI € 2.225,00  
NE/SA/GC € 1.796,00

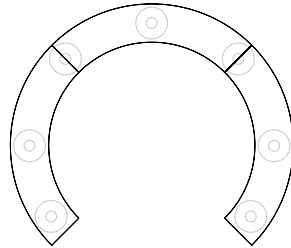

### B863\_LC

BI € 1.143,00  
NE/SA/GC € 928,00

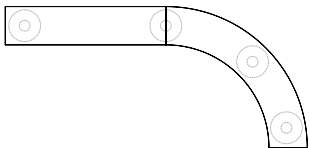

### B863\_LCC

BI € 1.853,00  
NE/SA/GC € 1.495,00

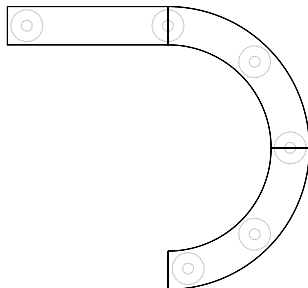

### B863\_CLC

BI € 1.853,00  
NE/SA/GC € 1.495,00

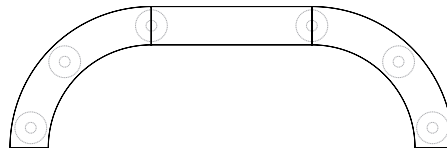

### B863\_LLC

BI € 1.482,00  
NE/SA/GC € 1.194,00

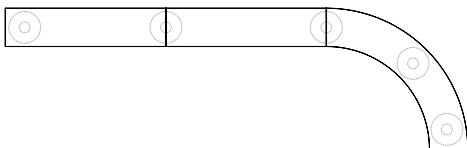

### B863\_LCL

BI € 1.482,00  
NE/SA/GC € 1.194,00

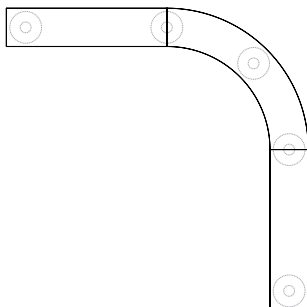

# Examples of IKON Bench combinations

Esempi di configurazioni IKON Bench

## B863\_LLLC

BI € 1.820,00  
NE/SA/GC € 1.460,00

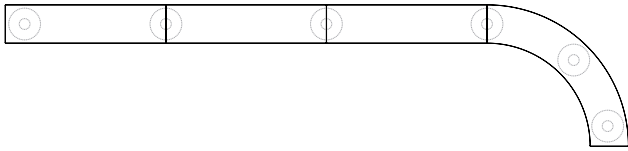

## B863\_LLCL

BI € 1.820,00  
NE/SA/GC € 1.460,00

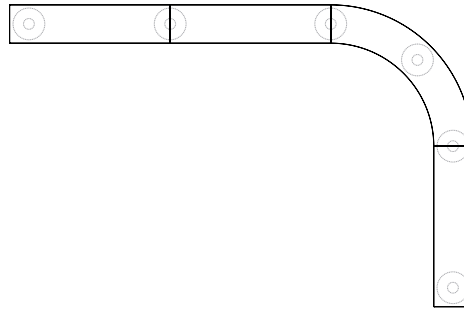

## B863\_CCCL

BI € 2.563,00  
NE/SA/GC € 2.062,00

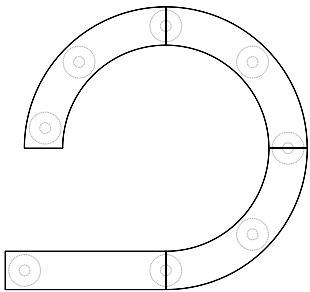

## B863\_CCLC

BI € 2.563,00  
NE/SA/GC € 2.062,00

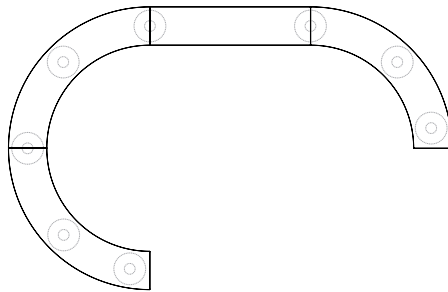

## B863\_CCLL

BI € 2.192,00  
NE/SA/GC € 1.761,00

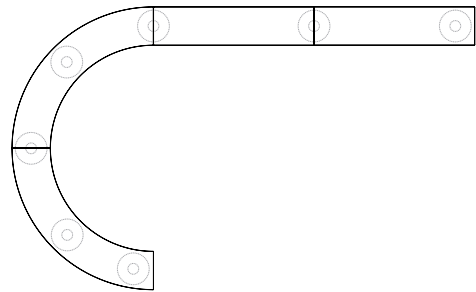

## B863\_LCCL

BI € 2.192,00  
NE/SA/GC € 1.761,00

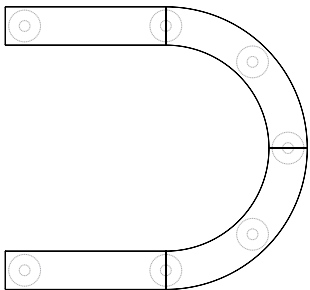

## B863\_CLLC

BI € 2.192,00  
NE/SA/GC € 1.761,00

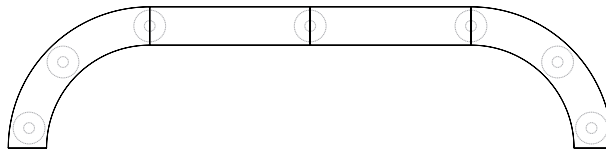

## B863\_CLCL

BI € 2.192,00  
NE/SA/GC € 1.761,00

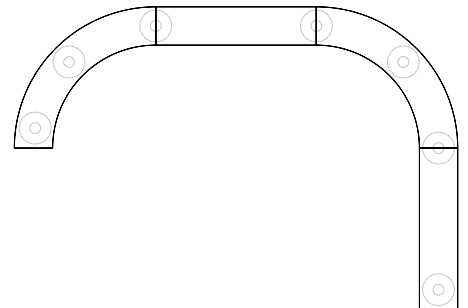

## B863C\_CLCLCLCL

BI € 4.198,00  
NE/SA/GC € 3.337,00

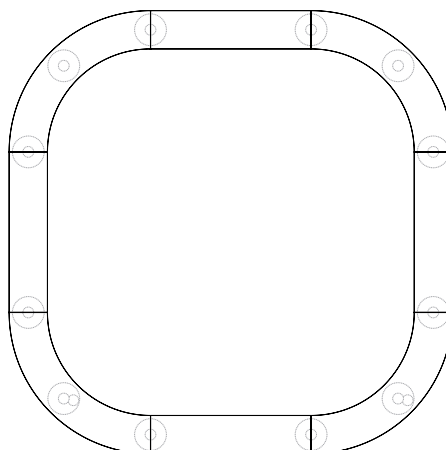

## B863C\_CLCCLC

BI € 3.520,00  
NE/SA/GC € 2.804,00

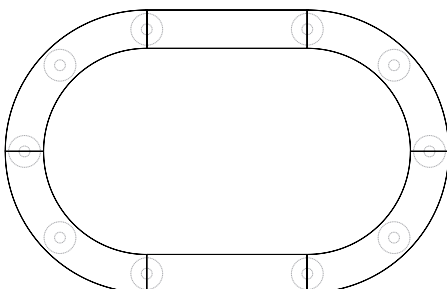

## B863C\_4C

BI € 2.843,00  
NE/SA/GC € 2.272,00

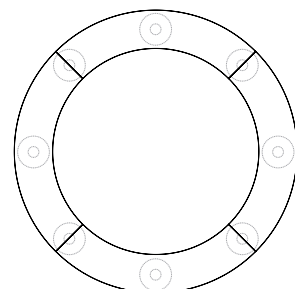

## Ila 2020

LOUNGE



SEAT Sedile	BACK Schienale	FRAME Telaio	POWDER COATED Verniciato	TITANIUM Titanio
C210+C217 D40+D44 D120+D123	C210+C217 D40+D44 D120+D123	Ø 580	€ 1.722,00	€ 1.980,00
E	E		€ 1.832,00	€ 2.090,00
G	G		€ 2.140,00	€ 2.398,00
G180+G185 G230+G239	G180+G185 G230+G239		€ 2.008,00	€ 2.266,00
H*	H*		€ 2.140,00	€ 2.398,00
H40+H53	H40+H53		€ 1.760,00	€ 2.019,00
N*	N*		€ 1.892,00	€ 2.151,00
P*	P*		€ 2.085,00	€ 2.343,00
			€ 2.382,00	€ 2.640,00

\*Excluding / Escluso H120+H127, N20+N27, PBS-PCO-PMS-PVE

For fabrics see page 367  
Per i tessuti si veda a p. 367

Upcharge for double-colour upholstery (fabric inner-leather outer) € 33,00  
Supplemento tappezzeria bicolore (fronte tessuto-retro pelle) € 33,00

PACKING / Imballo

TECHNICAL DETAILS / Dettagli tecnici

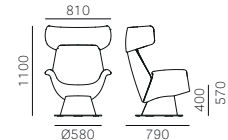

### SAFETY, STRENGTH and DURABILITY TESTS

Prove di sicurezza, resistenza e durata  
EN 1728:2012+AC2013  
EN 16139:2013 level 2

## Ila 2021

LOUNGE

Without headrest  
Senza poggiatesta



SEAT Sedile	BACK Schienale	FRAME Telaio	POWDER COATED Verniciato	TITANIUM Titanio
C210+C217 D40+D44 D120+D123	C210+C217 D40+D44 D120+D123	Ø 580	€ 1.414,00	€ 1.672,00
E	E		€ 1.502,00	€ 1.760,00
G	G		€ 1.755,00	€ 2.013,00
G180+G185 G230+G239	G180+G185 G230+G239		€ 1.639,00	€ 1.898,00
H*	H*		€ 1.755,00	€ 2.013,00
H40+H53	H40+H53		€ 1.447,00	€ 1.705,00
N*	N*		€ 1.562,00	€ 1.821,00
P*	P*		€ 1.700,00	€ 1.958,00
			€ 1.903,00	€ 2.162,00

\*Excluding / Escluso H120+H127, N20+N27, PBS-PCO-PMS-PVE

For fabrics see page 367  
Per i tessuti si veda a p. 367

Upcharge for double-colour upholstery (fabric inner-leather outer) € 33,00  
Supplemento tappezzeria bicolore (fronte tessuto-retro pelle) € 33,00

PACKING / Imballo

TECHNICAL DETAILS / Dettagli tecnici

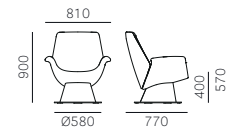

### SAFETY, STRENGTH and DURABILITY TESTS

Prove di sicurezza, resistenza e durata  
EN 1728:2012+AC2013  
EN 16139:2013 level 2

## Ila 2022

LOUNGE



SEAT Sedile	BACK Schienale	FRAME Telaio	POWDER COATED Verniciato
C210+C217 D40+D44 D120+D123	C210+C217 D40+D44 D120+D123	Ø 30	€ 1.485,00
E	E		€ 1.595,00
G	G		€ 1.903,00
G180+G185 G230+G239	G180+G185 G230+G239		€ 1.771,00
H*	H*		€ 1.903,00
H40+H53	H40+H53		€ 1.524,00
N*	N*		€ 1.656,00
P*	P*		€ 1.848,00
			€ 2.145,00

\*Excluding / Escluso H120+H127, N20+N27, PBS-PCO-PMS-PVE

For fabrics see page 367  
Per i tessuti si veda a p. 367

Upcharge for double-colour upholstery (fabric inner-leather outer) € 33,00  
Supplemento tappezzeria bicolore (fronte tessuto-retro pelle) € 33,00

PACKING / Imballo

TECHNICAL DETAILS / Dettagli tecnici

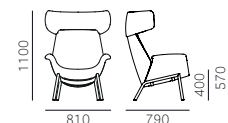

### SAFETY, STRENGTH and DURABILITY TESTS

Prove di sicurezza, resistenza e durata  
EN 1728:2012+AC2013  
EN 16139:2013 level 2

For colours and finishes see at page 362  
Per colori e finiture vedere da pagina 362

## Ila 2023

LOUNGE  
Without headrest  
Senza poggiatesta



SEAT Sedile	BACK Schienale	FRAME Telaio
C210+C217	C210+C217	Ø 30
D40+D44	D40+D44	
D120+D123	D120+D123	
E	E	
G	G	
G180+G185	G180+G185	
G230+G239	G230+G239	
H*	H*	
H40+H53	H40+H53	
N*	N*	
P*	P*	

\*Excluding / Escluso H120+H127, N20+N27, PBS-PCO-PMS-PVE

For fabrics see page 367  
Per i tessuti si veda a p. 367

POWDER COATED  
Verniciato

€ 1.177,00  
€ 1.265,00  
€ 1.518,00  
€ 1.403,00  
€ 1.518,00  
€ 1.210,00  
€ 1.326,00  
€ 1.463,00  
€ 1.667,00

Upcharge for double-colour upholstery (fabric inner-leather outer) € 33,00  
Supplemento tappezzeria bicolore (fronte tessuto-retro pelle) € 33,00

PACKING / Imballo



TECHNICAL DETAILS / Dettagli tecnici

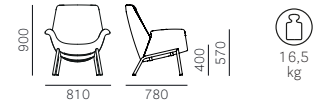

SAFETY, STRENGTH and DURABILITY TESTS  
Prove di sicurezza, resistenza e durata  
EN 1728:2012+AC2013  
EN 16139:2013 level 2

## Ila 2024

LOUNGE



SEAT Sedile	BACK Schienale	FRAME Telaio
C210+C217	C210+C217	FR-N1-AN
D40+D44	D40+D44	
D120+D123	D120+D123	
E	E	
G	G	
G180+G185	G180+G185	
G230+G239	G230+G239	
H*	H*	
H40+H53	H40+H53	
N*	N*	
P*	P*	

\*Excluding / Escluso H120+H127, N20+N27, PBS-PCO-PMS-PVE

FINISHES / Finiture



For fabrics see page 367  
Per i tessuti si veda a p. 367

ASH  
Frassino

€ 1.595,00  
€ 1.705,00  
€ 2.013,00  
€ 1.881,00  
€ 2.013,00  
€ 1.634,00  
€ 1.766,00  
€ 1.958,00  
€ 2.255,00

Upcharge for double-colour upholstery (fabric inner-leather outer) € 33,00  
Supplemento tappezzeria bicolore (fronte tessuto-retro pelle) € 33,00

PACKING / Imballo



TECHNICAL DETAILS / Dettagli tecnici

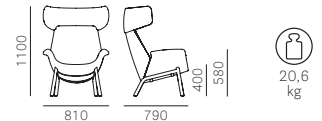

## Ila 2025

LOUNGE  
Without headrest  
Senza poggiatesta



SEAT Sedile	BACK Schienale	FRAME Telaio
C210+C217	C210+C217	FR-N1-AN
D40+D44	D40+D44	
D120+D123	D120+D123	
E	E	
G	G	
G180+G185	G180+G185	
G230+G239	G230+G239	
H*	H*	
H40+H53	H40+H53	
N*	N*	
P*	P*	

\*Excluding / Escluso H120+H127, N20+N27, PBS-PCO-PMS-PVE

FINISHES / Finiture



For fabrics see page 367  
Per i tessuti si veda a p. 367

ASH  
Frassino

€ 1.287,00  
€ 1.375,00  
€ 1.628,00  
€ 1.513,00  
€ 1.628,00  
€ 1.320,00  
€ 1.436,00  
€ 1.573,00  
€ 1.777,00

Upcharge for double-colour upholstery (fabric inner-leather outer) € 33,00  
Supplemento tappezzeria bicolore (fronte tessuto-retro pelle) € 33,00

PACKING / Imballo



TECHNICAL DETAILS / Dettagli tecnici



For colours and finishes see at page 362  
Per colori e finiture vedere da pagina 362

## Inga 5613



SEAT Sedile	BACK Schienale	FRAME Telaio	POWDER COATED Verniciato	CHROMED Cromato	ANTIQU BRASS Ottone antico
RS-W-AN	RS-W-AN		€ 150,00	€ 150,00	€ 226,00
V101- V102-V103	V101- V102-V103	Ø 16	€ 175,00	€ 175,00	€ 251,00
TC *	TC *		€ 161,00	€ 161,00	€ 237,00

\*Stained on sample: minimum order 20 pcs  
Tinta campione: ordine minimo 20 pz

### FINISHES / Finiture



### PACKING / Imballo



### TECHNICAL DETAILS / Dettagli tecnici

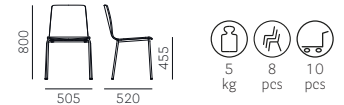

## Inga 5619



SEAT Sedile	BACK Schienale	FRAME Telaio	POWDER COATED Verniciato	CHROMED Cromato	ANTIQU BRASS Ottone antico
RS-W-AN	RS-W-AN		€ 156,00	€ 150,00	€ 226,00
V101- V102-V103	V101- V102-V103	Ø 10	€ 182,00	€ 175,00	€ 251,00
TC *	TC *		€ 167,00	€ 161,00	€ 237,00

\*Stained on sample: minimum order 20 pcs  
Tinta campione: ordine minimo 20 pz

### FINISHES / Finiture



### PACKING / Imballo



### TECHNICAL DETAILS / Dettagli tecnici

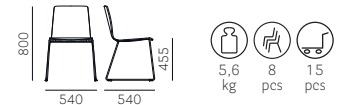

**SAFETY, STRENGTH and DURABILITY TESTS**  
Prove di sicurezza, resistenza e durata  
EN 1728:2012+AC2013  
EN 16139:2013 level 2

## Inga 5663



SEAT Sedile	BACK Schienale	FRAME Telaio	POWDER COATED Verniciato	CHROMED Cromato	ANTIQU BRASS Ottone antico
F01+F09	F01+F09		€ 287,00	€ 287,00	€ 363,00
F11+F19	F11+F19	Ø 16	€ 185,00	€ 185,00	€ 261,00

Matching stitches  
Cuciture in tinta  
For fabrics see page 367  
Per i tessuti si veda a p. 367

### PACKING / Imballo



### TECHNICAL DETAILS / Dettagli tecnici



For colours and finishes see at page 362  
Per colori e finiture vedere da pagina 362

## Inga 5669



SEAT Sedile	BACK Schienale	FRAME Telaio	POWDER COATED Verniciato	CHROMED Cromato	ANTIQU BRASS Ottone antico
F01+F09	F01+F09	Ø 10	€ 293,00	€ 287,00	€ 363,00
F11+F19	F11+F19		€ 191,00	€ 185,00	€ 261,00

Matching stitches  
Cuciture in tinta

For fabrics see page 367  
Per i tessuti si veda a p. 367

\*Panel for stacking: surcharge € 25,00 (item IMPO2\_NE)  
Pannello per impilaggio: supplemento € 25,00 (art.IMPO2\_NE)

### PACKING / Imballo



### TECHNICAL DETAILS / Dettagli tecnici

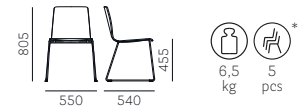

**SAFETY, STRENGTH and DURABILITY TESTS**  
Prove di sicurezza, resistenza e durata  
EN 1728:2012+AC2013  
EN 16139:2013 level 2

## Inga 5683



SEAT Sedile	BACK Schienale	FRAME Telaio	POWDER COATED Verniciato	CHROMED Cromato	ANTIQU BRASS Ottone antico
A	A	Ø 16	€ 193,00	€ 193,00	€ 269,00
C **	C **		€ 216,00	€ 216,00	€ 292,00
D40+D44	D40+D44		€ 247,00	€ 247,00	€ 323,00
G	G		€ 285,00	€ 285,00	€ 361,00
H **	H **		€ 220,00	€ 220,00	€ 297,00
P	P		€ 315,00	€ 315,00	€ 391,00
TC ***	TC ***		€ 193,00	€ 193,00	€ 269,00

\*\*\*TC = Minimum order 10 pcs each fabric colour  
TC = Ordine minimo 10 pz per colore/tessuto

\*\*Excluding / Escluso C36+C39, H140+H143

\*Panel for stacking: surcharge € 25,00 (item IMPO2\_NE)  
Pannello per impilaggio: supplemento € 25,00 (art.IMPO2\_NE)

For fabrics see page 367  
Per i tessuti si veda a p. 367

### PACKING / Imballo



**FABRIC REQUIRED / Fabbisogno tessuto**  
1pc: Lin Mtrs 0,85 (h 1,40)

### TECHNICAL DETAILS / Dettagli tecnici



## Inga 5689



SEAT Sedile	BACK Schienale	FRAME Telaio	POWDER COATED Verniciato	CHROMED Cromato	ANTIQU BRASS Ottone antico
A	A	Ø 10	€ 199,00	€ 193,00	€ 269,00
C **	C **		€ 222,00	€ 216,00	€ 292,00
D40+D44	D40+D44		€ 253,00	€ 247,00	€ 323,00
G	G		€ 291,00	€ 285,00	€ 361,00
H **	H **		€ 227,00	€ 220,00	€ 297,00
P	P		€ 321,00	€ 315,00	€ 391,00
TC ***	TC ***		€ 199,00	€ 193,00	€ 269,00

\*\*\*TC = Minimum order 10 pcs each fabric colour  
TC = Ordine minimo 10 pz per colore/tessuto

\*\*Excluding / Escluso C36+C39, H140+H143

\*Panel for stacking: surcharge € 25,00 (item IMPO2\_NE)  
Pannello per impilaggio: supplemento € 25,00 (art.IMPO2\_NE)

For fabrics see page 367  
Per i tessuti si veda a p. 367

### PACKING / Imballo



**FABRIC REQUIRED / Fabbisogno tessuto**  
1pc: Lin Mtrs 0,85 (h 1,40)

### TECHNICAL DETAILS / Dettagli tecnici



**SAFETY, STRENGTH and DURABILITY TESTS**  
Prove di sicurezza, resistenza e durata  
EN 1728:2012+AC2013  
EN 16139:2013 level 2

For colours and finishes see at page 362  
Per colori e finiture vedere da pagina 362

## Inga 5614



SEAT Sedile	BACK Schienale	FRAME Telaio	POWDER COATED Verniciato	CHROMED Cromato	ANTIQU BRASS Ottone antico
RS-W-AN	RS-W-AN		€ 165,00	€ 165,00	€ 234,00
V101- V102-V103	V101- V102-V103	Ø 16	€ 188,00	€ 188,00	€ 257,00
TC *	TC *		€ 175,00	€ 175,00	€ 245,00

\*Stained on sample: minimum order 20 pcs  
Tinta campione: ordine minimo 20 pz

### FINISHES / Finiture



### PACKING / Imballo



### TECHNICAL DETAILS / Dettagli tecnici



## Inga 5664



SEAT Sedile	BACK Schienale	FRAME Telaio	POWDER COATED Verniciato	CHROMED Cromato	ANTIQU BRASS Ottone antico
F01+F09	F01+F09		€ 289,00	€ 289,00	€ 359,00
F11+F19	F11+F19	Ø 16	€ 197,00	€ 197,00	€ 266,00

Matching stitches  
Cuciture in tinta

For fabrics see page 367  
Per i tessuti si veda a p. 367

### PACKING / Imballo



### TECHNICAL DETAILS / Dettagli tecnici



## Inga 5684



SEAT Sedile	BACK Schienale	FRAME Telaio	POWDER COATED Verniciato	CHROMED Cromato	ANTIQU BRASS Ottone antico
A	A		€ 204,00	€ 204,00	€ 273,00
C **	C **		€ 225,00	€ 225,00	€ 294,00
D40+D44	D40+D44		€ 253,00	€ 253,00	€ 322,00
G	G	Ø 16	€ 287,00	€ 287,00	€ 356,00
H **	H **		€ 229,00	€ 229,00	€ 298,00
P	P		€ 340,00	€ 340,00	€ 425,00
TC ***	TC ***		€ 204,00	€ 204,00	€ 273,00

\*\*\*TC = Minimum order 10 pcs each fabric colour  
TC = Ordine minimo 10 pz per colore/tessuto

\*\*Excluding / Escluso C36+C39, H140+H143

\*Panel for stacking: surcharge € 25,00 (item IMP02\_NE)  
Pannello per impilaggio: supplemento € 25,00 (art.IMP02\_NE)

For fabrics see page 367  
Per i tessuti si veda a p. 367

### PACKING / Imballo



FABRIC REQUIRED / Fabbisogno tessuto  
1 pc: Lin Mtrs 0,85 (h 1,40)

### TECHNICAL DETAILS / Dettagli tecnici



For colours and finishes see at page 362  
Per colori e finiture vedere da pagina 362

## Inga 5685

Upholstered armrests  
Braccioli imbottiti



SEAT Sedile	BACK Schienale	FRAME Telaio	POWDER COATED Verniciato	CHROMED Cromato	ANTIQU BRASS Ottone anticato
A	A		€ 308,00	€ 308,00	€ 377,00
C**	C**		€ 329,00	€ 329,00	€ 398,00
D40+D44	D40+D44		€ 357,00	€ 357,00	€ 426,00
G	G	Ø 16	€ 391,00	€ 391,00	€ 460,00
H**	H**		€ 333,00	€ 333,00	€ 402,00
P	P		€ 444,00	€ 444,00	€ 529,00
TC***	TC***		€ 308,00	€ 308,00	€ 377,00

\*\*\*TC = Minimum order 10 pcs each fabric colour  
TC = Ordine minimo 10 pz per colore/tessuto

\*\*Excluding / Escluso C36+C39, H140+H143

\*Panel for stacking: surcharge € 25,00 (item IMP02\_NE)  
Pannello per impilaggio: supplemento € 25,00 (art.IMP02\_NE)

For fabrics see page 367  
Per i tessuti si veda a p. 367

PACKING / Imballo



FABRIC REQUIRED / Fabbisogno tessuto  
1pc: Lin Mtrs 1,35 (h 1,40)

TECHNICAL DETAILS / Dettagli tecnici

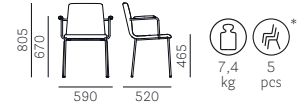

## Inga 5616



SEAT Sedile	BACK Schienale	FRAME Telaio	POWDER COATED Verniciato	CHROMED Cromato	ANTIQU BRASS Ottone anticato
RS-W-AN	RS-W-AN		€ 171,00	€ 171,00	€ 246,00
V101- V102-V103	V101- V102-V103	Ø 16 H670	€ 194,00	€ 194,00	€ 269,00
TC*	TC*		€ 181,00	€ 181,00	€ 256,00

\*Stained on sample: minimum order 20 pcs  
Tinta campione: ordine minimo 20 pz

FINISHES / Finiture



PACKING / Imballo



TECHNICAL DETAILS / Dettagli tecnici



## Inga 5617



SEAT Sedile	BACK Schienale	FRAME Telaio	POWDER COATED Verniciato	CHROMED Cromato	ANTIQU BRASS Ottone anticato
RS-W-AN	RS-W-AN		€ 173,00	€ 173,00	€ 248,00
V101- V102-V103	V101- V102-V103	Ø 16 H770	€ 196,00	€ 196,00	€ 271,00
TC*	TC*		€ 183,00	€ 183,00	€ 258,00

\*Stained on sample: minimum order 20 pcs  
Tinta campione: ordine minimo 20 pz

FINISHES / Finiture



PACKING / Imballo



TECHNICAL DETAILS / Dettagli tecnici



For colours and finishes see at page 362  
Per colori e finiture vedere da pagina 362





## Inga 5686



SEAT Sedile	BACK Schienale	FRAME Telaio	POWDER COATED Verniciato	CHROMED Cromato	ANTIQU BRASS Ottone anticato
A	A	Ø 16 H680	€ 210,00	€ 210,00	€ 285,00
C*	C*		€ 230,00	€ 230,00	€ 306,00
D40÷D44	D40÷D44		€ 259,00	€ 259,00	€ 328,00
G	G		€ 293,00	€ 293,00	€ 368,00
H*	H*		€ 235,00	€ 235,00	€ 310,00
P	P		€ 346,00	€ 346,00	€ 421,00
TC**	TC**		€ 210,00	€ 210,00	€ 285,00

\*\*TC = Minimum order 10 pcs each fabric colour  
TC = Ordine minimo 10 pz per colore/tessuto

\*Excluding / Escluso C36÷C39, H140+H143

For fabrics see page 367  
Per i tessuti si veda a p. 367

PACKING / Imballo



FABRIC REQUIRED / Fabbisogno tessuto  
1pc: Lin Mtrs 0,66 (h 1,40)

TECHNICAL DETAILS / Dettagli tecnici



## Inga 5687



SEAT Sedile	BACK Schienale	FRAME Telaio	POWDER COATED Verniciato	CHROMED Cromato	ANTIQU BRASS Ottone anticato
A	A	Ø 16 H780	€ 212,00	€ 212,00	€ 287,00
C*	C*		€ 233,00	€ 233,00	€ 308,00
D40÷D44	D40÷D44		€ 261,00	€ 261,00	€ 331,00
G	G		€ 295,00	€ 295,00	€ 370,00
H*	H*		€ 237,00	€ 237,00	€ 312,00
P	P		€ 348,00	€ 348,00	€ 423,00
TC**	TC**		€ 212,00	€ 212,00	€ 287,00

\*\*TC = Minimum order 10 pcs each fabric colour  
TC = Ordine minimo 10 pz per colore/tessuto

\*Excluding / Escluso C36÷C39, H140+H143

For fabrics see page 367  
Per i tessuti si veda a p. 367

PACKING / Imballo



FABRIC REQUIRED / Fabbisogno tessuto  
1pc: Lin Mtrs 0,66 (h 1,40)

TECHNICAL DETAILS / Dettagli tecnici



## Inga 5681

LOUNGE



SEAT Sedile	BACK Schienale	FRAME Telaio	POWDER COATED Verniciato	CHROMED Cromato
A	A	Ø 16	€ 307,00	€ 307,00
C*	C*		€ 332,00	€ 332,00
D40÷D44	D40÷D44		€ 363,00	€ 363,00
G	G		€ 413,00	€ 413,00
H*	H*		€ 345,00	€ 345,00
P	P		€ 452,00	€ 452,00
TC**	TC**		€ 307,00	€ 307,00

\*\*TC = Minimum order 10 pcs each fabric colour  
TC = Ordine minimo 10 pz per colore/tessuto

\*Excluding / Escluso C36÷C39, H140+H143

For fabrics see page 367  
Per i tessuti si veda a p. 367

PACKING / Imballo



FABRIC REQUIRED / Fabbisogno tessuto  
1pc: Lin Mtrs 0,90 (h 1,40)

TECHNICAL DETAILS / Dettagli tecnici



For colours and finishes see at page 362  
Per colori e finiture vedere da pagina 362

## Inga 5688

LOUNGE



SEAT Sedile	BACK Schienale	FRAME Telaio	POWDER COATED Verniciato	CHROMED Cromato
A	A		€ 318,00	€ 318,00
C*	C*		€ 344,00	€ 344,00
D40÷D44	D40÷D44		€ 375,00	€ 375,00
G	G	Ø 11	€ 425,00	€ 425,00
H*	H*		€ 356,00	€ 356,00
P	P		€ 464,00	€ 464,00
TC**	TC**		€ 318,00	€ 318,00

\*\*TC = Minimum order 10 pcs each fabric colour  
TC = Ordine minimo 10 pz per colore/tessuto

\*Excluding / Escluso C36÷C39, H140+H143

For fabrics see page 367  
Per i tessuti si veda a p. 367

PACKING / Imballo



FABRIC REQUIRED / Fabbisogno tessuto  
1pc: Lin Mtrs 0,90 (h 1,40)

TECHNICAL DETAILS / Dettagli tecnici

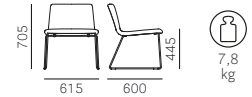

## Intrigo 3715



SEAT Sedile	BACK Schienale	FRAME Telaio	POWDER COATED Verniciato
METAL	METAL	METAL	€ 281,00

FINISHES / Finiture



PACKING / Imballo



TECHNICAL DETAILS / Dettagli tecnici

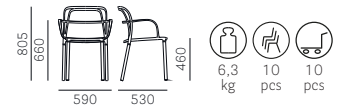

SAFETY, STRENGTH and DURABILITY TESTS  
Prove di sicurezza, resistenza e durata  
EN 1728:2012+AC2013  
EN 16139:2013 level 2

## Intrigo 3715.5

Seat cushion  
Cuscino per sedile



SEAT Sedile	FABRIC Tessuto
D22÷D26 D80÷D89 D100÷D105 D110÷D115 D130÷D133	€ 89,00

For fabrics see page 367  
Per i tessuti si veda a p. 367

PACKING / Imballo



TECHNICAL DETAILS / Dettagli tecnici



For colours and finishes see at page 362  
Per colori e finiture vedere da pagina 362

## Intrigo 3715.20

Seat + back cushion  
Cuscino per sedile e schienale



SEAT Sedile	BACK Schienale	FABRIC Tessuto
D22+D26 D80+D89 D100+D105 D110+D115 D130+D133	D22+D26 D80+D89 D100+D105 D110+D115 D130+D133	<b>€ 145,00</b>

For fabrics see page 367  
Per i tessuti si veda a p. 367

**PACKING / Imballo**



**TECHNICAL DETAILS / Dettagli tecnici**

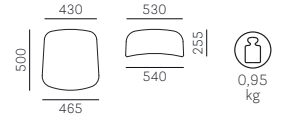

## Island 795-795E



SEAT Sedile	BACK Schienale	FRAME Telaio	FABRIC Tessuto
B01+B02 C90+C95	B01+B02 C90+C95	Ø 900	<b>€ 571,00</b> 795
D22+D26 D80+D89 D100+D105 D110+D115 D130+D133	D22+D26 D80+D89 D100+D105 D110+D115 D130+D133		<b>€ 714,00</b> 795E

For fabrics see page 367  
Per i tessuti si veda a p. 367

**PACKING / Imballo**



**TECHNICAL DETAILS / Dettagli tecnici**

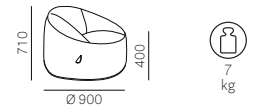

## Island 796-796E



SEAT Sedile	FRAME Telaio	FABRIC Tessuto
B01+B02 C90+C95	Ø 650	<b>€ 310,00</b> 796
D22+D26 D80+D89 D100+D105 D110+D115 D130+D133		<b>€ 357,00</b> 796E

For fabrics see page 367  
Per i tessuti si veda a p. 367

**PACKING / Imballo**



**TECHNICAL DETAILS / Dettagli tecnici**



## Island 797-797E



SEAT Sedile	FRAME Telaio	FABRIC Tessuto
B01+B02 C90+C95	Ø 900	€ 413,00 797
D22+D26 D80+D89 D100+D105 D110+D115 D130+D133		€ 515,00 797E

For fabrics see page 367  
Per i tessuti si veda a p. 367

PACKING / Imballo



TECHNICAL DETAILS / Dettagli tecnici



## Jamaica 2910



SEAT Sedile	BACK Schienale	FRAME Telaio	POWDER COATED Verniciato	GOLD LACQUERED Laccato oro	BLACK NICKEL Nichel nero	ANTIQU BRASS Ottone antico
FR-AN	FR-AN	FR-AN	€ 302,00	€ 340,00	€ 357,00	€ 357,00

FINISHES / Finiture



PACKING / Imballo



TECHNICAL DETAILS / Dettagli tecnici



SAFETY, STRENGTH and DURABILITY TESTS  
Prove di sicurezza, resistenza e durata  
EN 1728:2012+AC2013  
EN 16139:2013 level 2

## Jamaica 2911



SEAT Sedile	BACK Schienale	FRAME Telaio	POWDER COATED Verniciato	GOLD LACQUERED Laccato oro	BLACK NICKEL Nichel nero	ANTIQU BRASS Ottone antico
A	A	FR-AN	€ 391,00	€ 429,00	€ 446,00	€ 446,00
C*	C*		€ 413,00	€ 451,00	€ 468,00	€ 468,00
D40+D44	D40+D44		€ 439,00	€ 478,00	€ 494,00	€ 494,00
E	E		€ 480,00	€ 519,00	€ 535,00	€ 535,00
G	G		€ 480,00	€ 519,00	€ 535,00	€ 535,00
H*	H*		€ 423,00	€ 461,00	€ 478,00	€ 478,00
P*	P*		€ 621,00	€ 659,00	€ 676,00	€ 676,00
TC**	TC**		€ 391,00	€ 429,00	€ 446,00	€ 446,00
CL**	CL**		€ 396,00	€ 435,00	€ 451,00	€ 451,00

\*\*TC/CL = Minimum order 10 pcs each fabric colour  
TC/CL = Ordine minimo 10 pz per colore/tessuto

\*Excluding / Escluso C36+C39, H140+H143, PBS-PCO-PMS-PVE

FINISHES / Finiture



For fabrics see page 367  
Per i tessuti si veda a p. 367

PACKING / Imballo



TECHNICAL DETAILS / Dettagli tecnici



FABRIC REQUIRED / Fabbisogno tessuto

1pc: Lin Mtrs 0,80 (h 1,40)  
fabric and simil leather / tessuto e finta pelle  
1pc: Square Mtrs 1,60 mid-grain leather / pelle mezzo fiore

SAFETY, STRENGTH and DURABILITY TESTS  
Prove di sicurezza, resistenza e durata  
EN 1728:2012+AC2013  
EN 16139:2013 level 2

For colours and finishes see at page 362  
Per colori e finiture vedere da pagina 362

## Jamaica 2915



SEAT Sedile	BACK Schienale	FRAME Telaio	POWDER COATED Verniciato	GOLD LACQUERED Laccato oro	BLACK NICKEL Nichel nero	ANTIQU BRASS Ottone antico
FR-AN	FR-AN	FR-AN	€ 311,00	€ 349,00	€ 366,00	€ 366,00

## FINISHES / Finiture



SAFETY, STRENGTH and DURABILITY TESTS  
Prove di sicurezza, resistenza e durata  
EN 1728:2012+AC2013  
EN 16139:2013 level 2

## PACKING / Imballo



## TECHNICAL DETAILS / Dettagli tecnici



## Jamaica 2916



SEAT Sedile	BACK Schienale	FRAME Telaio	POWDER COATED Verniciato	GOLD LACQUERED Laccato oro	BLACK NICKEL Nichel nero	ANTIQU BRASS Ottone antico
A	A	FR-AN	€ 400,00	€ 438,00	€ 455,00	€ 455,00
C*	C*		€ 422,00	€ 460,00	€ 477,00	€ 477,00
D40+D44	D40+D44		€ 448,00	€ 487,00	€ 503,00	€ 503,00
E	E		€ 489,00	€ 527,00	€ 544,00	€ 544,00
G	G		€ 489,00	€ 527,00	€ 544,00	€ 544,00
H*	H*		€ 432,00	€ 470,00	€ 487,00	€ 487,00
P*	P*		€ 630,00	€ 668,00	€ 685,00	€ 685,00
TC**	TC**		€ 400,00	€ 438,00	€ 455,00	€ 455,00
CL**	CL**		€ 405,00	€ 444,00	€ 460,00	€ 460,00

\*\*TC/CL = Minimum order 10 pcs each fabric colour  
TC/CL = Ordine minimo 10 pz per colore/tessuto

\*Excluding / Escluso C36+C39, H140+H143, PBS-PCO-PMS-PVE

## FINISHES / Finiture



SAFETY, STRENGTH and DURABILITY TESTS  
Prove di sicurezza, resistenza e durata  
EN 1728:2012+AC2013  
EN 16139:2013 level 2

For fabrics see page 367  
Per i tessuti si veda a p. 367

## PACKING / Imballo



## TECHNICAL DETAILS / Dettagli tecnici



## FABRIC REQUIRED / Fabbisogno tessuto

1 pc: Lin Mtrs 0,80 (h 1,40)  
fabric and simil leather / tessuto e finta pelle  
1 pc: Square Mtrs 1,60 mid-grain leather / pelle mezzo fiore

## Jazz 3719

Stackable\*  
Impilabile\*



SEAT Sedile	BACK Schienale	FRAME Telaio	POWDER COATED Verniciato	GOLD LACQUERED Laccato oro	BRUSHED BRONZE Bronzo satinato	ANTIQU BRASS Ottone antico	ANTIQU COPPER Rame antico	TITANIUM Titanio
C83+C89; C100+C101 C110+C122 C130+C141 C210+C217	C83+C89; C100+C101 C110+C122 C130+C141 C210+C217	Ø 16	€ 253,00	€ 303,00	€ 319,00	€ 319,00	€ 319,00	€ 319,00
D120+D123	D120+D123		€ 275,00	€ 325,00	€ 341,00	€ 341,00	€ 341,00	€ 341,00
E	E		€ 308,00	€ 358,00	€ 374,00	€ 374,00	€ 374,00	€ 374,00
G	G		€ 308,00	€ 358,00	€ 374,00	€ 374,00	€ 374,00	€ 374,00
H	H		€ 262,00	€ 312,00	€ 328,00	€ 328,00	€ 328,00	€ 328,00
TC**	TC**		€ 236,00	€ 285,00	€ 302,00	€ 302,00	€ 302,00	€ 302,00

\*\*TC = Minimum order 10 pcs each fabric colour. Feasibility to be approved  
TC = Ordine minimo 10 pz per colore/tessuto. Fattibilità da valutare

For fabrics see page 367  
Per i tessuti si veda a p. 367

\*Panel for stacking: surcharge € 22,00 (item IMP04\_NE)  
Pannello per impilaggio: supplemento € 22,00 (art.IMP04\_NE)

Stacking for velvet upholstery is not recommended  
Si sconsiglia l'impilaggio con il velluto  
(cat. E, G180+G185, G230+G239, H40+H53)

SAFETY, STRENGTH and DURABILITY TESTS  
Prove di sicurezza, resistenza e durata  
EN 1728:2012+AC2013  
EN 16139:2013 level 2

## PACKING / Imballo



## TECHNICAL DETAILS / Dettagli tecnici

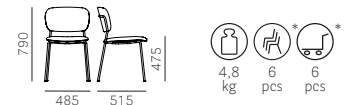

## FABRIC REQUIRED / Fabbisogno tessuto

1 pc: Lin Mtrs 0,65 (h 1,40)

For colours and finishes see at page 362  
Per colori e finiture vedere da pagina 362

## Jazz 3716



SEAT Sedile	BACK Schienale	FRAME Telaio	POWDER COATED Verniciato	GOLD LACQUERED Laccato oro	BRUSHED BRONZE Bronzo satinato	ANTIQU BRASS Ottone anticato	ANTIQU COPPER Rame anticato	TITANIUM Titanio
C83+C89; C100+C101 C110+C122 C130+C141 C210+C217 D120+D123	C83+C89; C100+C101 C110+C122 C130+C141 C210+C217 D120+D123	Ø 16	€ 427,00	€ 497,00	€ 513,00	€ 513,00	€ 513,00	€ 513,00
E	E		€ 470,00	€ 520,00	€ 536,00	€ 536,00	€ 536,00	€ 536,00
G	G		€ 544,00	€ 613,00	€ 630,00	€ 630,00	€ 630,00	€ 630,00
H	H		€ 544,00	€ 613,00	€ 630,00	€ 630,00	€ 630,00	€ 630,00
TC *	TC *		€ 443,00	€ 512,00	€ 528,00	€ 528,00	€ 528,00	€ 528,00
			€ 388,00	€ 457,00	€ 473,00	€ 473,00	€ 473,00	€ 473,00

\*TC = Minimum order 10 pcs each fabric colour. Feasibility to be approved  
TC = Ordine minimo 10 pz per colore/tessuto. Fattibilità da valutare

For fabrics see page 367  
Per i tessuti si veda a p. 367

PACKING / Imballo



FABRIC REQUIRED / Fabbisogno tessuto  
1pc: Lin Mtrs 1,60 (h 1,40)

TECHNICAL DETAILS / Dettagli tecnici

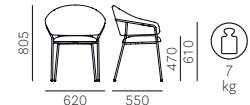

SAFETY, STRENGTH and DURABILITY TESTS  
Prove di sicurezza, resistenza e durata  
EN 1728:2012+AC2013  
EN 16139:2013 level 2

## Jazz 3717



SEAT Sedile	BACK Schienale	FRAME Telaio	POWDER COATED Verniciato	GOLD LACQUERED Laccato oro	BRUSHED BRONZE Bronzo satinato	ANTIQU BRASS Ottone anticato	ANTIQU COPPER Rame anticato	TITANIUM Titanio
C83+C89; C100+C101 C110+C122 C130+C141 C210+C217 D120+D123	C83+C89; C100+C101 C110+C122 C130+C141 C210+C217 D120+D123	Ø 16 H660	€ 436,00	€ 521,00	€ 554,00	€ 554,00	€ 554,00	€ 554,00
E	E		€ 476,00	€ 525,00	€ 542,00	€ 542,00	€ 542,00	€ 542,00
G	G		€ 536,00	€ 621,00	€ 654,00	€ 654,00	€ 654,00	€ 654,00
H	H		€ 536,00	€ 621,00	€ 654,00	€ 654,00	€ 654,00	€ 654,00
TC *	TC *		€ 449,00	€ 534,00	€ 567,00	€ 567,00	€ 567,00	€ 567,00
			€ 399,00	€ 483,00	€ 516,00	€ 516,00	€ 516,00	€ 516,00

\*TC = Minimum order 10 pcs each fabric colour. Feasibility to be approved  
TC = Ordine minimo 10 pz per colore/tessuto. Fattibilità da valutare

For fabrics see page 367  
Per i tessuti si veda a p. 367

PACKING / Imballo



FABRIC REQUIRED / Fabbisogno tessuto  
1pc: Lin Mtrs 1,40 (h 1,40)

TECHNICAL DETAILS / Dettagli tecnici

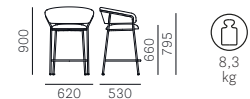

## Jazz 3718



SEAT Sedile	BACK Schienale	FRAME Telaio	POWDER COATED Verniciato	GOLD LACQUERED Laccato oro	BRUSHED BRONZE Bronzo satinato	ANTIQU BRASS Ottone anticato	ANTIQU COPPER Rame anticato	TITANIUM Titanio
C83+C89; C100+C101 C110+C122 C130+C141 C210+C217 D120+D123	C83+C89; C100+C101 C110+C122 C130+C141 C210+C217 D120+D123	Ø 16 H760	€ 438,00	€ 523,00	€ 556,00	€ 556,00	€ 556,00	€ 556,00
E	E		€ 478,00	€ 528,00	€ 544,00	€ 544,00	€ 544,00	€ 544,00
G	G		€ 538,00	€ 623,00	€ 656,00	€ 656,00	€ 656,00	€ 656,00
H	H		€ 538,00	€ 623,00	€ 656,00	€ 656,00	€ 656,00	€ 656,00
TC *	TC *		€ 451,00	€ 536,00	€ 569,00	€ 569,00	€ 569,00	€ 569,00
			€ 401,00	€ 486,00	€ 519,00	€ 519,00	€ 519,00	€ 519,00

\*TC = Minimum order 10 pcs each fabric colour. Feasibility to be approved  
TC = Ordine minimo 10 pz per colore/tessuto. Fattibilità da valutare

For fabrics see page 367  
Per i tessuti si veda a p. 367

PACKING / Imballo



FABRIC REQUIRED / Fabbisogno tessuto  
1pc: Lin Mtrs 1,40 (h 1,40)

TECHNICAL DETAILS / Dettagli tecnici



For colours and finishes see at page 362  
Per colori e finiture vedere da pagina 362



Removable lining  
Rivestimento sfoderabile

CODE Codice	SEAT Sedile	BACK Schienale	FABRIC Tessuto
<b>JEFF001</b> Linear without armrests Lineare senza braccioli	D120÷D123	D120÷D123	€ 3.120,00
	G *	G *	€ 3.450,00
	H140÷H143	H140÷H143	€ 3.010,00
	N01÷N08 N30÷N38	N01÷N08 N30÷N38	€ 3.610,00
<b>JEFF002</b> Linear with right armrest Lineare con bracciolo DX	D120÷D123	D120÷D123	€ 4.100,00
	G *	G *	€ 4.550,00
<b>JEFF003</b> Linear with left armrest Lineare con bracciolo SX	H140÷H143	H140÷H143	€ 3.950,00
	N01÷N08 N30÷N38	N01÷N08 N30÷N38	€ 4.770,00
<b>JEFF004</b> End piece with right armrest Terminale con bracciolo DX	D120÷D123	D120÷D123	€ 3.540,00
	G *	G *	€ 3.900,00
<b>JEFF005</b> End piece with left armrest Terminale con bracciolo SX	H140÷H143	H140÷H143	€ 3.400,00
	N01÷N08 N30÷N38	N01÷N08 N30÷N38	€ 4.080,00
<b>JEFF006</b> Right end piece without armrest Terminale DX senza bracciolo	D120÷D123	D120÷D123	€ 2.850,00
	G *	G *	€ 3.120,00
<b>JEFF007</b> Left end piece without armrest Terminale SX senza bracciolo	H140÷H143	H140÷H143	€ 2.750,00
	N01÷N08 N30÷N38	N01÷N08 N30÷N38	€ 3.250,00
<b>JEFF008</b> Chaise longue with right armrest Chaise longue con bracciolo DX	D120÷D123	D120÷D123	€ 3.790,00
	G *	G *	€ 4.180,00
<b>JEFF009</b> Chaise longue with left armrest Chaise longue con bracciolo SX	H140÷H143	H140÷H143	€ 3.650,00
	N01÷N08 N30÷N38	N01÷N08 N30÷N38	€ 4.370,00
<b>JEFF010</b> Corner 120° Angolare 120°	D120÷D123	D120÷D123	€ 5.290,00
	G *	G *	€ 5.810,00
	H140÷H143	H140÷H143	€ 5.090,00
	N01÷N08 N30÷N38	N01÷N08 N30÷N38	€ 6.080,00

\*Excluding / Escluso G07, G100+G102, G130+G133, G150+G156, G180+G185, G200+G206, G230+G239

Optional cushions available on request see page 345  
Disponibili a richiesta i cuscini accessori si veda a p. 345

For fabrics see page 367  
Per i tessuti si veda a p. 367

## TECHNICAL DETAILS / Dettagli tecnici

### JEFF001

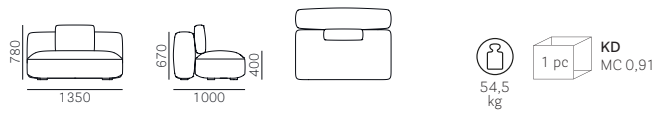

### JEFF002

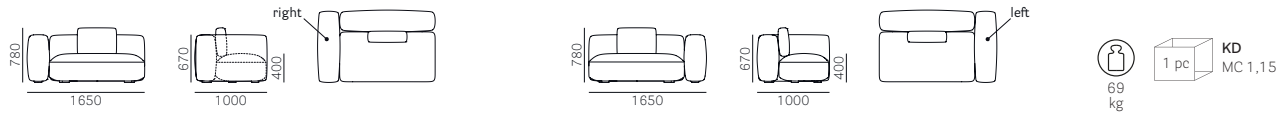

### JEFF003

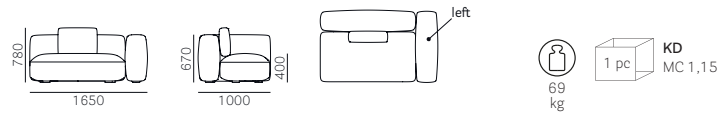

### JEFF004

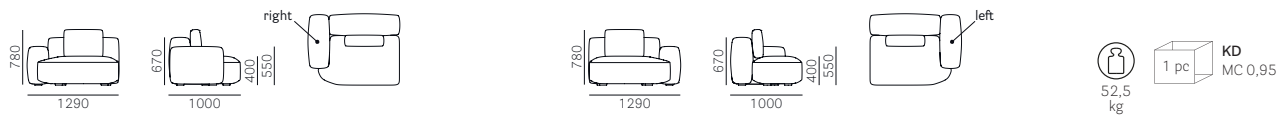

### JEFF005

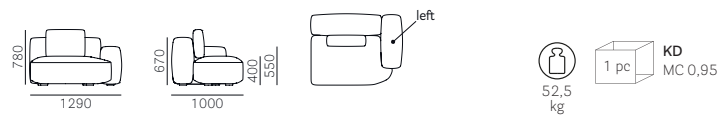

### JEFF006

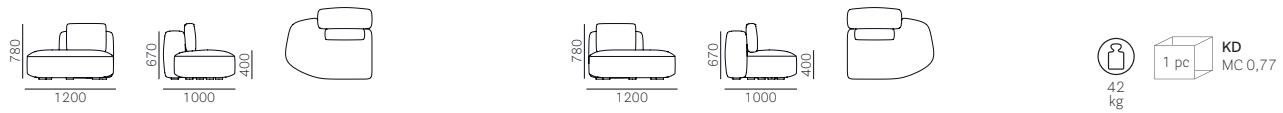

### JEFF007

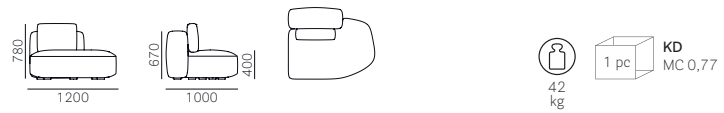

### JEFF008

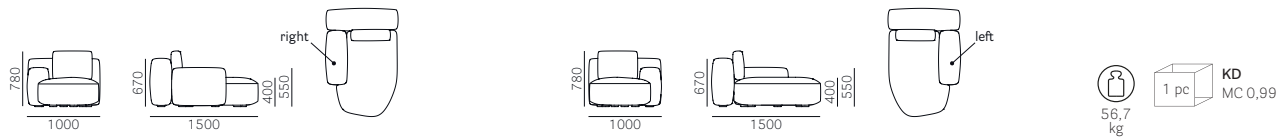

### JEFF009

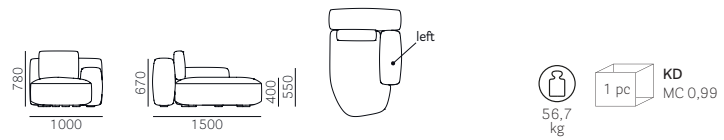

### JEFF010

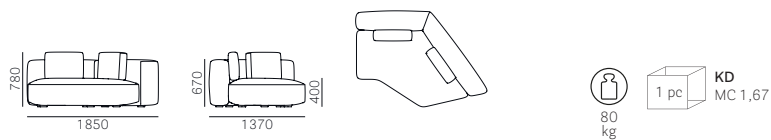



Examples of JEFF combinations

Esempi di configurazioni JEFF

JEFF004 + 005

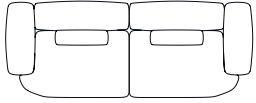

JEFF004 + 001 + 005

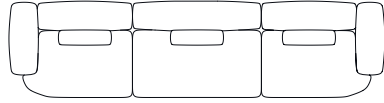

JEFF004 + 001 + 009

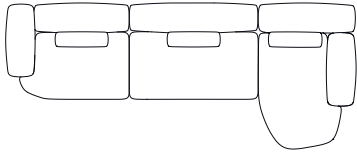

JEFF008 + 001 + 005

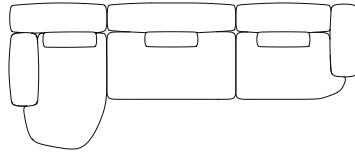

JEFF006 + 001 + 009

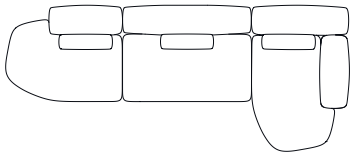

JEFF008 + 001 + 007

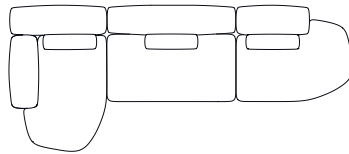

JEFF004 + 003 + 001 + 001 + 005

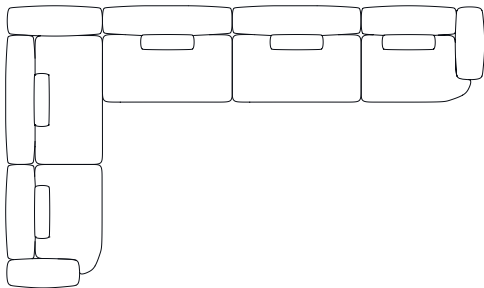

JEFF004 + 001 + 001 + 002 + 007

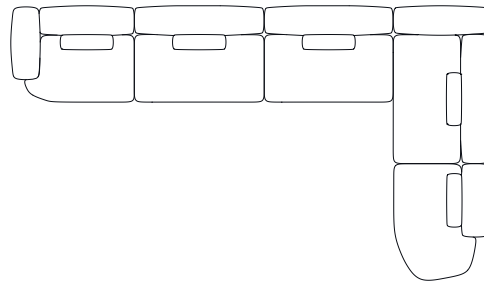

JEFF004 + 003 + 001 + 007

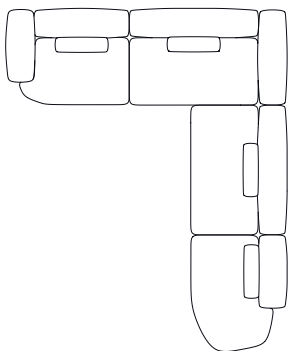

JEFF004 + 010 + 001 + 007

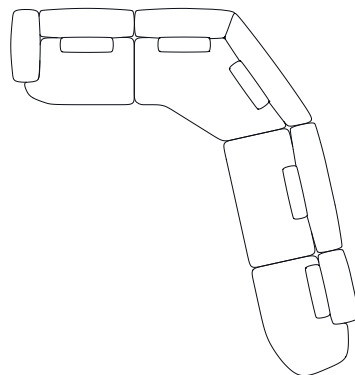

JEFF004 + 001 + 010 + 005

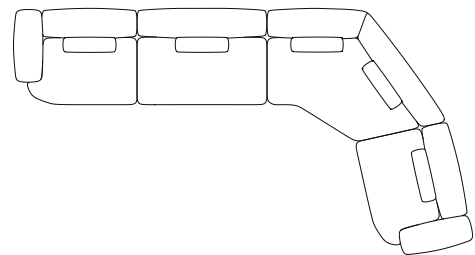

## Jil 520



SEAT Sedile	BACK Schienale	FRAME Telaio	OAK Rovere	OAK STAINED ON SAMPLE Rovere tinto campione
A	A		€ 362,00	€ 384,00
C*	C*		€ 393,00	€ 415,00
G	G	RS-W-N1- GC-BI	€ 484,00	€ 506,00
H*	H*		€ 398,00	€ 420,00
P*	P*	TC	€ 516,00	€ 538,00
TC**	TC**		€ 362,00	€ 384,00
CL**	CL**		€ 373,00	€ 395,00

\*\*TC/CL = Minimum order 10 pcs each fabric colour  
TC/CL = Ordine minimo 10 pz per colore/tessuto

\*Excluding / Escluso C36+C39, H140+H143, PBS-PCO-PMS-PVE

## FINISHES / Finiture



RS N1 GC BI

W Tobacco shade /  
Tinto tabacco

W

SAFETY, STRENGTH and DURABILITY TESTS  
Prove di sicurezza, resistenza e durata  
EN 1728:2000

For fabrics see page 367  
Per i tessuti si veda a p. 367

## PACKING / Imballo



FABRIC REQUIRED / Fabbisogno tessuto  
1pc: Lin Mtrs 1,10 (h 1,40)

Minimum order q.ty: 20 pcs  
Ordine minimo: 20pz

## TECHNICAL DETAILS / Dettagli tecnici

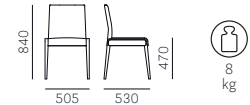

## Jil 525



SEAT Sedile	BACK Schienale	FRAME Telaio	OAK Rovere	OAK STAINED ON SAMPLE Rovere tinto campione
A	A		€ 500,00	€ 522,00
C*	C*		€ 552,00	€ 574,00
G	G	RS-W-N1- GC-BI	€ 710,00	€ 732,00
H*	H*		€ 561,00	€ 583,00
P*	P*	TC	€ 765,00	€ 787,00
TC**	TC**		€ 500,00	€ 522,00
CL**	CL**		€ 511,00	€ 533,00

\*\*TC/CL = Minimum order 10 pcs each fabric colour  
TC/CL = Ordine minimo 10 pz per colore/tessuto

\*Excluding / Escluso C36+C39, H140+H143, PBS-PCO-PMS-PVE

## FINISHES / Finiture



RS N1 GC BI

W Tobacco shade /  
Tinto tabacco

W

SAFETY, STRENGTH and DURABILITY TESTS  
Prove di sicurezza, resistenza e durata  
EN 1728:2000

For fabrics see page 367  
Per i tessuti si veda a p. 367

## PACKING / Imballo



FABRIC REQUIRED / Fabbisogno tessuto  
1pc: Lin Mtrs 1,90 (h 1,40)

Minimum order q.ty: 20 pcs  
Ordine minimo: 20pz

## TECHNICAL DETAILS / Dettagli tecnici



## Jil 526



SEAT Sedile	BACK Schienale	FRAME Telaio	OAK Rovere	OAK STAINED ON SAMPLE Rovere tinto campione
A	A		€ 522,00	€ 544,00
C*	C*		€ 552,00	€ 574,00
G	G		€ 643,00	€ 665,00
H*	H*	H780	€ 558,00	€ 580,00
P*	P*		€ 675,00	€ 697,00
TC**	TC**		€ 522,00	€ 544,00
CL**	CL**		€ 533,00	€ 555,00

\*\*TC/CL = Minimum order 10 pcs each fabric colour  
TC/CL = Ordine minimo 10 pz per colore/tessuto

\*Excluding / Escluso C36+C39, H140+H143, PBS-PCO-PMS-PVE

## FINISHES / Finiture



RS N1 GC BI

W Tobacco shade /  
Tinto tabacco

W

For fabrics see page 367  
Per i tessuti si veda a p. 367

## PACKING / Imballo



FABRIC REQUIRED / Fabbisogno tessuto  
1pc: Lin Mtrs 0,82 (h 1,40)

Minimum order q.ty: 20 pcs  
Ordine minimo: 20pz

## TECHNICAL DETAILS / Dettagli tecnici

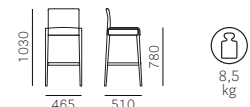

## Jil 521

LOUNGE



SEAT Sedile	BACK Schienale	FRAME Telaio	OAK Rovere	OAK STAINED ON SAMPLE Rovere tinto campione
A	A		€ 700,00	€ 722,00
C*	C*		€ 773,00	€ 795,00
G	G	RS-W-N1- GC-BI	€ 994,00	€ 1.016,00
H*	H*		€ 786,00	€ 808,00
P*	P*	TC	€ 1.071,00	€ 1.093,00
TC**	TC**		€ 700,00	€ 722,00
CL**	CL**		€ 715,00	€ 737,00

\*\*TC/CL = Minimum order 10 pcs each fabric colour  
TC/CL = Ordine minimo 10 pz per colore/tessuto

\*Excluding / Escluso C36+C39, H140+H143, PBS-PCO-PMS-PVE

### FINISHES / Finiture

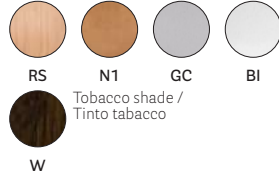

For fabrics see page 367  
Per i tessuti si veda a p. 367

### PACKING / Imballo



FABRIC REQUIRED / Fabbisogno tessuto  
1pc: Lin Mtrs 1,80 (h 1,40)

### TECHNICAL DETAILS / Dettagli tecnici

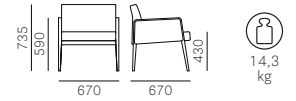

## Joi 870



SEAT Sedile	BACK Schienale	FRAME Telaio	ANODIZED ALUMINIUM Alluminio anodizzato
PPL	PPL	27x27	€ 58,00

### PPL FINISHES / Finiture PPL



### PACKING / Imballo



### TECHNICAL DETAILS / Dettagli tecnici

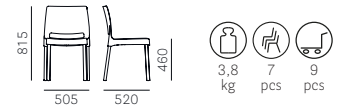

SAFETY, STRENGTH and DURABILITY TESTS  
Prove di sicurezza, resistenza e durata  
EN 1728:2000

## Joi 870/CL1

Fire retardant version  
Versione ignifuga



SEAT Sedile	BACK Schienale	FRAME Telaio	ANODIZED ALUMINIUM Alluminio anodizzato
PPL	PPL	27x27	€ 82,00

Minimum order 200 pcs each colour  
Ordine minimo 200 pz per colore

### PPL FINISHES / Finiture PPL



### PACKING / Imballo



### TECHNICAL DETAILS / Dettagli tecnici

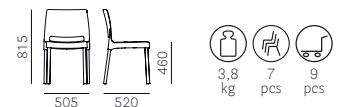

SAFETY, STRENGTH and DURABILITY TESTS  
Prove di sicurezza, resistenza e durata  
EN 1728:2000



## Joi 870/G

Linking device  
Gancio di collegamento



FRAME Telaio	NYLON Nylon
NY	€ 7,00
<p>PACKING / Imballo</p> <p>10 pcs MC 0,003</p>	
<p>TECHNICAL DETAILS / Dettagli tecnici</p>	

## Koi-Booki 370



SEAT Sedile	BACK Schienale	FRAME Telaio	POWDER COATED Verniciato
PPL	PPL	22x22	€ 105,00*
<p>FRAME/TELAIO* Powder coated in the same colour of the shell / Verniciato in tinta con la scocca</p> <p>PPL FINISHES / Finiture PPL</p>			
<p>PACKING / Imballo</p> <p>4 pcs MC 0,31</p>		<p>TECHNICAL DETAILS / Dettagli tecnici</p>	

SAFETY, STRENGTH and DURABILITY TESTS  
Prove di sicurezza, resistenza e durata  
EN 1728:2000

## Koi-Booki 370/CL1

Fire retardant version  
Versione ignifuga



SEAT Sedile	BACK Schienale	FRAME Telaio	WHITE POWDER COATED Verniciato bianco
PPL	PPL	22x22	€ 129,00
<p>Minimum order 100 pcs Ordine minimo 100 pz</p> <p>PPL FINISHES / Finiture PPL</p>			
<p>PACKING / Imballo</p> <p>4 pcs MC 0,31</p>		<p>TECHNICAL DETAILS / Dettagli tecnici</p>	

SAFETY, STRENGTH and DURABILITY TESTS  
Prove di sicurezza, resistenza e durata  
EN 1728:2000



For colours and finishes see at page 362  
Per colori e finiture vedere da pagina 362

## Koi-Booki 370.3

Cushion only  
Solo cuscino



SEAT Sedile	BACK Schienale	FABRIC Tessuto
GA	GA	<b>€ 80,00</b>

FINISHES / Finiture



GA

PACKING / Imballo



TECHNICAL DETAILS / Dettagli tecnici



## Koi-Booki 370/G

Linking device  
Gancio di collegamento



FRAME Telaio	ANODIZED ALUMINIUM Alluminio anodizzato
AA	<b>€ 33,00</b>

PACKING / Imballo



TECHNICAL DETAILS / Dettagli tecnici

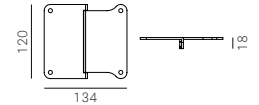

## Kuadra 1101



SEAT Sedile	BACK Schienale	FRAME Telaio	POWDER COATED Verniciato	CHROMED Cromato	SATINIZED Satinato
TP	TP	20x20	€ 112,00	€ 129,00	€ 157,00

TP FINISHES / Finiture TP



PACKING / Imballo



TECHNICAL DETAILS / Dettagli tecnici

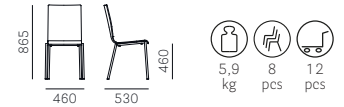

SAFETY, STRENGTH and DURABILITY TESTS  
Prove di sicurezza, resistenza e durata  
EN 1728:2000



## Kuadra 1329/TP



SEAT Sedile	BACK Schienale	FRAME Telaio	POWDER COATED Verniciato	CHROMED Cromato	SATINIZED Satinato
TP	TP	20x20	€ 207,00	€ 224,00	€ 252,00

With linking device (item CG), upcharge € 28,00  
Con gancio di collegamento (art.CG), supplemento € 28,00

Chromed armrest for chromed or powder coated frame; satinized armrest for satinized frame  
Bracciolo cromato per telaio cromato e verniciato; bracciolo satinato per telaio satinato

TP FINISHES / Finiture TP



TABLET FINISHES / Finiture tavoletta

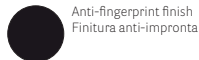

Anti-fingerprint finish  
Finitura anti-impronta  
FNP\_NE

PACKING / Imballo



TECHNICAL DETAILS / Dettagli tecnici

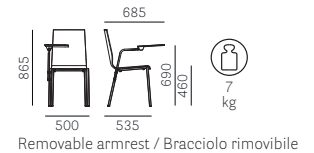

Removable armrest / Bracciolo rimovibile

## Kuadra 1151



SEAT Sedile	BACK Schienale	FRAME Telaio	POWDER COATED Verniciato	CHROMED Cromato	MATT CHROMED Cromato opaco	BRUSHED S/STEEL Inox satinato
TP	TP	Ø 16	€ 79,00	€ 79,00	€ 93,00	€ 151,00

TP FINISHES / Finiture TP



PACKING / Imballo



TECHNICAL DETAILS / Dettagli tecnici

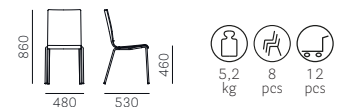

SAFETY, STRENGTH and DURABILITY TESTS  
Prove di sicurezza, resistenza e durata  
EN 1728:2000



For colours and finishes see at page 362  
Per colori e finiture vedere da pagina 362

## Kuadra 1158



SEAT Sedile	BACK Schienale	FRAME Telaio	POWDER COATED Verniciato	CHROMED Cromato
TP	TP	Ø 10	€ 91,00	€ 85,00

TP FINISHES / Finiture TP



PACKING / Imballo



TECHNICAL DETAILS / Dettagli tecnici

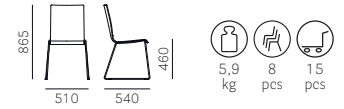

## Kuadra 1271



SEAT Sedile	BACK Schienale	FRAME Telaio	POWDER COATED Verniciato	CHROMED Cromato	SATINIZED Satinato
PC	PC	20x20	€ 154,00	€ 172,00	€ 196,00

PC FINISHES / Finiture PC



PACKING / Imballo



TECHNICAL DETAILS / Dettagli tecnici

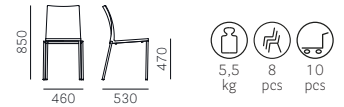

SAFETY, STRENGTH and DURABILITY TESTS  
Prove di sicurezza, resistenza e durata  
EN 1728:2000

## Kuadra 1301



SEAT Sedile	BACK Schienale	FRAME Telaio	POWDER COATED Verniciato	CHROMED Cromato	SATINIZED Satinato
RS-W	RS-W	20x20	€ 154,00	€ 172,00	€ 202,00
TC *	TC *		€ 166,00	€ 184,00	€ 214,00

\*Stained on sample: minimum order 20 pcs  
Tinta campione: ordine minimo 20 pz

### FINISHES / Finiture



### PACKING / Imballo



### TECHNICAL DETAILS / Dettagli tecnici

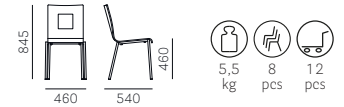

SAFETY, STRENGTH and DURABILITY TESTS  
Prove di sicurezza, resistenza e durata  
EN 1728:2000



## Kuadra 1311



SEAT Sedile	BACK Schienale	FRAME Telaio	POWDER COATED Verniciato	CHROMED Cromato	MATT CHROMED Cromato opaco
RS-W	RS-W	Ø 16	€ 131,00	€ 131,00	€ 147,00
TC *	TC *		€ 143,00	€ 143,00	€ 159,00

\*Stained on sample: minimum order 20 pcs  
Tinta campione: ordine minimo 20 pz

### FINISHES / Finiture



### PACKING / Imballo



### TECHNICAL DETAILS / Dettagli tecnici

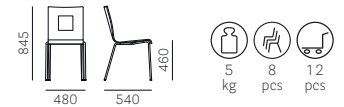

## Kuadra 1308



SEAT Sedile	BACK Schienale	FRAME Telaio	POWDER COATED Verniciato	CHROMED Cromato
RS-W	RS-W	Ø 10	€ 138,00	€ 131,00
TC *	TC *		€ 150,00	€ 143,00

\*Stained on sample: minimum order 20 pcs  
Tinta campione: ordine minimo 20 pz

### FINISHES / Finiture



### PACKING / Imballo



### TECHNICAL DETAILS / Dettagli tecnici

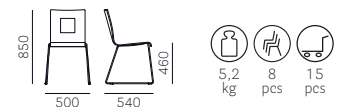

For colours and finishes see at page 362  
Per colori e finiture vedere da pagina 362



## Kuada 1321



SEAT Sedile	BACK Schienale	FRAME Telaio	POWDER COATED Verniciato	CHROMED Cromato	SATINIZED Satinato
RS-W	RS-W		€ 154,00	€ 172,00	€ 202,00
AN	AN	20x20	€ 154,00	€ 172,00	€ 202,00
TC *	TC *		€ 166,00	€ 184,00	€ 214,00

\*Stained on sample: minimum order 20 pcs  
Tinta campione: ordine minimo 20 pz

## FINISHES / Finiture



SAFETY, STRENGTH and DURABILITY TESTS  
Prove di sicurezza, resistenza e durata  
EN 1728:2000

## PACKING / Imballo



## TECHNICAL DETAILS / Dettagli tecnici

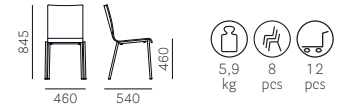

## Kuada 1321/A



SEAT Sedile	BACK Schienale	FRAME Telaio	POWDER COATED Verniciato	CHROMED Cromato	SATINIZED Satinato
A			€ 195,00	€ 212,00	€ 242,00
C **			€ 197,00	€ 215,00	€ 245,00
G			€ 213,00	€ 230,00	€ 262,00
H **	RS-W	20x20	€ 198,00	€ 216,00	€ 246,00
P **			€ 218,00	€ 235,00	€ 266,00
TC ***			€ 195,00	€ 212,00	€ 242,00
CL ***			€ 202,00	€ 218,00	€ 250,00

\*\*\*TC/CL = Minimum order 10 pcs each fabric colour  
TC/CL = Ordine minimo 10 pz per colore/tessuto

\*\*Excluding / Escluso C36+C39, H140+H143, PBS-PCO-PMS-PVE

## FINISHES / Finiture



SAFETY, STRENGTH and DURABILITY TESTS  
Prove di sicurezza, resistenza e durata  
EN 1728:2000

\*Panel for stacking: surcharge € 22,00 (item IMP03)  
Pannello per impilaggio: supplemento € 22,00 (art. IMP03)

For fabrics see page 367  
Per i tessuti si veda a p. 367

## PACKING / Imballo



FABRIC REQUIRED / Fabbisogno tessuto  
1pc: Lin Mtrs 0,60 (h 1,40)

## TECHNICAL DETAILS / Dettagli tecnici



## Kuada 1329



SEAT Sedile	BACK Schienale	FRAME Telaio	POWDER COATED Verniciato	CHROMED Cromato	SATINIZED Satinato
RS-W	RS-W		€ 250,00	€ 267,00	€ 298,00
AN	AN	20x20	€ 250,00	€ 267,00	€ 298,00
TC *	TC *		€ 262,00	€ 279,00	€ 310,00

\*Stained on sample: minimum order 20 pcs  
Tinta campione: ordine minimo 20 pz

With linking device (item CG), upcharge € 28,00  
Con gancio di collegamento (art.CG), supplemento € 28,00

Chromed armrest for chromed or powder coated frame; satinized armrest for satinized frame  
Bracciolo cromato per telaio cromato e verniciato; bracciolo satinato per telaio satinato

## FINISHES / Finiture



## TABLET FINISHES / Finiture tavoletta

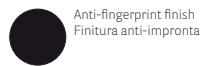

Anti-fingerprint finish  
Finitura anti-impronta  
FNP\_NE  
For colours and finishes see at page 362  
Per colori e finiture vedere da pagina 362

## PACKING / Imballo



## TECHNICAL DETAILS / Dettagli tecnici

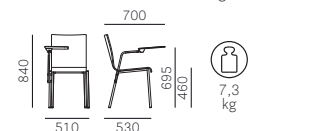

Removable armrest / Bracciolo rimovibile



## CG

Linking device  
Gancio di collegamento



FRAME Telaio	CHROMED Cromato
Ø 6	<b>€ 28,00</b> For chairs / Per sedie KUADRA 1301, 1311, 1321/A, 1321, 1329/TP, 1331, 1329
	For armchairs / Per poltrone KUADRA 1335, 1115, 1285, 1055
	<b>€ 44,00</b> For chairs / Per sedie KUADRA 1308, 1328

### TECHNICAL DETAILS / Dettagli tecnici

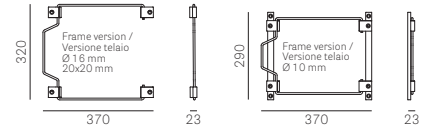

PATENTED / BREVETTATO

## Kuadra 1331



SEAT Sedile	BACK Schienale	FRAME Telaio	POWDER COATED Verniciato	CHROMED Cromato	MATT CHROMED Cromato opaco
RS-W	RS-W	Ø 16	<b>€ 131,00</b>	<b>€ 131,00</b>	<b>€ 147,00</b>
AN	AN		<b>€ 131,00</b>	<b>€ 131,00</b>	<b>€ 147,00</b>
TC *	TC *		<b>€ 143,00</b>	<b>€ 143,00</b>	<b>€ 159,00</b>

\*Stained on sample: minimum order 20 pcs  
Tinta campione: ordine minimo 20 pz

### FINISHES / Finiture



### PACKING / Imballo



### TECHNICAL DETAILS / Dettagli tecnici

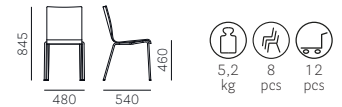

SAFETY, STRENGTH and DURABILITY TESTS  
Prove di sicurezza, resistenza e durata  
EN 1728:2000

## Kuadra 1328



SEAT Sedile	BACK Schienale	FRAME Telaio	POWDER COATED Verniciato	CHROMED Cromato
RS-W	RS-W	Ø 10	<b>€ 138,00</b>	<b>€ 131,00</b>
AN	AN		<b>€ 138,00</b>	<b>€ 131,00</b>
TC *	TC *		<b>€ 150,00</b>	<b>€ 143,00</b>

\*Stained on sample: minimum order 20 pcs  
Tinta campione: ordine minimo 20 pz

### FINISHES / Finiture



### PACKING / Imballo



### TECHNICAL DETAILS / Dettagli tecnici

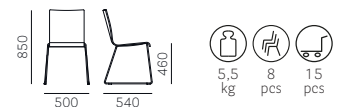

For colours and finishes see at page 362  
Per colori e finiture vedere da pagina 362



## Kuadra 1395



SEAT Sedile	BACK Schienale	FRAME Telaio	POWDER COATED Verniciato	CHROMED Cromato	SATINIZED Satinato
RS-W	RS-W		€ 159,00	€ 167,00	€ 194,00
AN	AN	Ø 25	€ 159,00	€ 167,00	€ 194,00
TC *	TC *		€ 172,00	€ 179,00	€ 206,00

\*Stained on sample: minimum order 20 pcs  
Tinta campione: ordine minimo 20 pz

### FINISHES / Finiture



### PACKING / Imballo



### TECHNICAL DETAILS / Dettagli tecnici

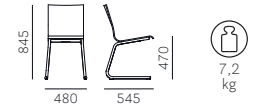

SAFETY, STRENGTH and DURABILITY TESTS  
Prove di sicurezza, resistenza e durata  
EN 1728:2012+AC2013  
EN 16139:2013 level 2



## Kuadra 1281



SEAT Sedile	BACK Schienale	FRAME Telaio	POWDER COATED Verniciato	CHROMED Cromato	MATT CHROMED Cromato opaco
F01+F09	F01+F09	Ø 16	€ 274,00	€ 274,00	€ 290,00
F11+F19	F11+F19		€ 167,00	€ 167,00	€ 184,00

\*Panel for stacking: surcharge € 22,00 (item IMP03)  
Pannello per impilaggio: supplemento € 22,00 (art.IMP03)

For fabrics see page 367  
Per i tessuti si veda a p. 367

### PACKING / Imballo



### TECHNICAL DETAILS / Dettagli tecnici



SAFETY, STRENGTH and DURABILITY TESTS  
Prove di sicurezza, resistenza e durata  
EN 1728:2000

## Kuadra 1291



SEAT Sedile	BACK Schienale	FRAME Telaio	POWDER COATED Verniciato	CHROMED Cromato	SATINIZED Satinato
F01+F09	F01+F09	20x20	€ 300,00	€ 318,00	€ 349,00
F11+F19	F11+F19		€ 200,00	€ 218,00	€ 242,00

\*Panel for stacking: surcharge € 22,00 (item IMP03)  
Pannello per impilaggio: supplemento € 22,00 (art.IMP03)

For fabrics see page 367  
Per i tessuti si veda a p. 367

### PACKING / Imballo



### TECHNICAL DETAILS / Dettagli tecnici



For colours and finishes see at page 362  
Per colori e finiture vedere da pagina 362

## Kuadra 1298



SEAT Sedile	BACK Schienale	FRAME Telaio	POWDER COATED Verniciato	CHROMED Cromato
F01+F09	F01+F09	Ø 10	€ 280,00	€ 274,00
F11+F19	F11+F19		€ 174,00	€ 167,00

\*Panel for stacking: surcharge € 22,00 (item IMP03)  
Pannello per impilaggio: supplemento € 22,00 (art.IMP03)

For fabrics see page 367  
Per i tessuti si veda a p. 367

PACKING / Imballo



TECHNICAL DETAILS / Dettagli tecnici



## Kuadra 1010



SEAT Sedile	BACK Schienale	FRAME Telaio	POWDER COATED Verniciato	CHROMED Cromato	SATINIZED Satinato
A	A	20x20	€ 209,00	€ 227,00	€ 249,00
C**	C**		€ 229,00	€ 246,00	€ 268,00
G	G		€ 288,00	€ 305,00	€ 327,00
H**	H**		€ 232,00	€ 250,00	€ 271,00
TC***	TC***		€ 209,00	€ 227,00	€ 249,00

\*\*\*TC = Minimum order 10 pcs each fabric colour  
TC = Ordine minimo 10 pz per colore/tessuto

\*\*Excluding / Escluso C36+C39, H140+H143

\*Panel for stacking: surcharge € 22,00 (item IMP03)  
Pannello per impilaggio: supplemento € 22,00 (art. IMP03)

For fabrics see page 367  
Per i tessuti si veda a p. 367

PACKING / Imballo



TECHNICAL DETAILS / Dettagli tecnici



SAFETY, STRENGTH and DURABILITY TESTS  
Prove di sicurezza, resistenza e durata  
EN 1728:2000

FABRIC REQUIRED / Fabbisogno tessuto  
1pc: Lin Mtrs 1,00 (h 1,40)

## Kuadra 1051



SEAT Sedile	BACK Schienale	FRAME Telaio	POWDER COATED Verniciato	CHROMED Cromato	MATT CHROMED Cromato opaco
A	A	Ø 16	€ 179,00	€ 179,00	€ 197,00
C**	C**		€ 198,00	€ 198,00	€ 216,00
G	G		€ 258,00	€ 258,00	€ 275,00
H**	H**		€ 202,00	€ 202,00	€ 219,00
TC***	TC***		€ 179,00	€ 179,00	€ 197,00

\*\*\*TC = Minimum order 10 pcs each fabric colour  
TC = Ordine minimo 10 pz per colore/tessuto

\*\*Excluding / Escluso C36+C39, H140+H143

\*Panel for stacking: surcharge € 22,00 (item IMP03)  
Pannello per impilaggio: supplemento € 22,00 (art. IMP03)

For fabrics see page 367  
Per i tessuti si veda a p. 367

PACKING / Imballo



TECHNICAL DETAILS / Dettagli tecnici



SAFETY, STRENGTH and DURABILITY TESTS  
Prove di sicurezza, resistenza e durata  
EN 1728:2000

FABRIC REQUIRED / Fabbisogno tessuto  
1pc: Lin Mtrs 1,00 (h 1,40)

For colours and finishes see at page 362  
Per colori e finiture vedere da pagina 362

## Kuadra 1058



SEAT Sedile	BACK Schienale	FRAME Telaio	POWDER COATED Verniciato	CHROMED Cromato
A	A		€ 187,00	€ 180,00
C **	C **		€ 207,00	€ 200,00
G	G	Ø 10	€ 266,00	€ 259,00
H **	H **		€ 210,00	€ 203,00
TC ***	TC ***		€ 187,00	€ 180,00

\*\*\*TC = Minimum order 10 pcs each fabric colour  
TC = Ordine minimo 10 pz per colore/tessuto

\*\*Excluding / Escluso C36+C39, H140+H143

\*Panel for stacking: surcharge € 22,00 (item IMP03)  
Pannello per impilaggio: supplemento € 22,00 (art. IMP03)

For fabrics see page 367  
Per i tessuti si veda a p. 367

PACKING / Imballo



FABRIC REQUIRED / Fabbisogno tessuto  
1pc: Lin Mtrs 1,00 (h 1,40)

TECHNICAL DETAILS / Dettagli tecnici



## Kuadra 1115



SEAT Sedile	BACK Schienale	FRAME Telaio	POWDER COATED Verniciato	CHROMED Cromato	MATT CHROMED Cromato opaco	BRUSHED S/STEEL Inox satinato
TP	TP	Ø 16	€ 112,00	€ 112,00	€ 124,00	€ 206,00

TP FINISHES / Finiture TP



PACKING / Imballo



TECHNICAL DETAILS / Dettagli tecnici



## Kuadra 1335



SEAT Sedile	BACK Schienale	FRAME Telaio	POWDER COATED Verniciato	CHROMED Cromato	MATT CHROMED Cromato opaco
RS-W	RS-W		€ 161,00	€ 161,00	€ 182,00
AN	AN	Ø 16	€ 161,00	€ 161,00	€ 182,00
TC *	TC *		€ 173,00	€ 173,00	€ 194,00

\*Stained on sample: minimum order 20 pcs  
Tinta campione: ordine minimo 20 pz

FINISHES / Finiture



PACKING / Imballo



TECHNICAL DETAILS / Dettagli tecnici



For colours and finishes see at page 362  
Per colori e finiture vedere da pagina 362



## Kuadra 1285



SEAT Sedile	BACK Schienale	FRAME Telaio	POWDER COATED Verniciato	CHROMED Cromato	MATT CHROMED Cromato opaco
F01+F09	F01+F09	Ø 16	€ 307,00	€ 307,00	€ 329,00
F11+F19	F11+F19		€ 200,00	€ 200,00	€ 222,00

\*Panel for stacking: surcharge € 22,00 (item IMP03)  
Pannello per impilaggio: supplemento € 22,00 (art.IMP03)

For fabrics see page 367  
Per i tessuti si veda a p. 367

PACKING / Imballo



TECHNICAL DETAILS / Dettagli tecnici



## Kuadra 1055



SEAT Sedile	BACK Schienale	FRAME Telaio	POWDER COATED Verniciato	CHROMED Cromato	MATT CHROMED Cromato opaco
A	A	Ø 16	€ 206,00	€ 206,00	€ 216,00
C**	C**		€ 224,00	€ 224,00	€ 233,00
G	G		€ 284,00	€ 284,00	€ 294,00
H**	H**		€ 229,00	€ 229,00	€ 238,00
TC***	TC***		€ 206,00	€ 206,00	€ 216,00

\*\*\*TC = Minimum order 10 pcs each fabric colour  
TC = Ordine minimo 10 pz per colore/tessuto

\*\*Excluding / Escluso C36+C39, H140+H143

\*Panel for stacking: surcharge € 22,00 (item IMP03)  
Pannello per impilaggio: supplemento € 22,00 (art. IMP03)

For fabrics see page 367  
Per i tessuti si veda a p. 367

PACKING / Imballo



TECHNICAL DETAILS / Dettagli tecnici



FABRIC REQUIRED / Fabbisogno tessuto  
1pc: Lin Mtrs 1,00 (h 1,40)

## Kuadra 1102



SEAT Sedile	BACK Schienale	FRAME Telaio	POWDER COATED Verniciato	CHROMED Cromato	SATINIZED Satinato
TP	TP	20x20 H650	€ 139,00	€ 155,00	€ 182,00

TP FINISHES / Finiture TP



PACKING / Imballo



TECHNICAL DETAILS / Dettagli tecnici



For colours and finishes see at page 362  
Per colori e finiture vedere da pagina 362



## Kuadra 1106



SEAT Sedile	BACK Schienale	FRAME Telaio	POWDER COATED Verniciato	CHROMED Cromato	SATINIZED Satinato
TP	TP	20x20 H800	€ 163,00	€ 179,00	€ 203,00

TP FINISHES / Finiture TP



PACKING / Imballo



TECHNICAL DETAILS / Dettagli tecnici



## Kuadra 1112



SEAT Sedile	BACK Schienale	FRAME Telaio	POWDER COATED Verniciato	CHROMED Cromato	MATT CHROMED Cromato opaco
TP	TP	Ø 16 H670	€ 105,00	€ 105,00	€ 119,00

TP FINISHES / Finiture TP



PACKING / Imballo



TECHNICAL DETAILS / Dettagli tecnici



SAFETY, STRENGTH and DURABILITY TESTS  
Prove di sicurezza, resistenza e durata  
EN 1728:2012+AC2013  
EN 16139:2013 level 2

## Kuadra 1116



SEAT Sedile	BACK Schienale	FRAME Telaio	POWDER COATED Verniciato	CHROMED Cromato	MATT CHROMED Cromato opaco
TP	TP	Ø 16 H770	€ 107,00	€ 107,00	€ 121,00

TP FINISHES / Finiture TP



PACKING / Imballo



TECHNICAL DETAILS / Dettagli tecnici



For colours and finishes see at page 362  
Per colori e finiture vedere da pagina 362

## Kuadra 1322



SEAT Sedile	BACK Schienale	FRAME Telaio	POWDER COATED Verniciato	CHROMED Cromato	SATINIZED Satinato
RS-W-AN	RS-W-AN	20x20 H650	€ 187,00	€ 203,00	€ 226,00
TC *	TC *		€ 198,00	€ 214,00	€ 236,00

\*Stained on sample: minimum order 20 pcs  
Tinta campione: ordine minimo 20pz

### FINISHES / Finiture



### PACKING / Imballo



### TECHNICAL DETAILS / Dettagli tecnici



## Kuadra 1326



SEAT Sedile	BACK Schienale	FRAME Telaio	POWDER COATED Verniciato	CHROMED Cromato	SATINIZED Satinato
RS-W-AN	RS-W-AN	20x20 H800	€ 211,00	€ 227,00	€ 251,00
TC *	TC *		€ 222,00	€ 238,00	€ 262,00

\*Stained on sample: minimum order 20 pcs  
Tinta campione: ordine minimo 20pz

### FINISHES / Finiture



### PACKING / Imballo



### TECHNICAL DETAILS / Dettagli tecnici



## Kuadra 1332



SEAT Sedile	BACK Schienale	FRAME Telaio	POWDER COATED Verniciato	CHROMED Cromato	MATT CHROMED Cromato opaco
RS-W-AN	RS-W-AN	Ø 16 H670	€ 164,00	€ 164,00	€ 179,00
TC *	TC *		€ 175,00	€ 175,00	€ 190,00

\*Stained on sample: minimum order 20 pcs  
Tinta campione: ordine minimo 20pz

### FINISHES / Finiture



### PACKING / Imballo



### TECHNICAL DETAILS / Dettagli tecnici



For colours and finishes see at page 362  
Per colori e finiture vedere da pagina 362



## Kuadra 1336



SEAT Sedile	BACK Schienale	FRAME Telaio	POWDER COATED Verniciato	CHROMED Cromato	MATT CHROMED Cromato opaco
RS-W-AN	RS-W-AN	Ø 16 H770	€ 167,00	€ 167,00	€ 181,00
TC *	TC *		€ 178,00	€ 178,00	€ 192,00

\*Stained on sample: minimum order 20 pcs  
Tinta campione: ordine minimo 20pz

### FINISHES / Finiture



### PACKING / Imballo



### TECHNICAL DETAILS / Dettagli tecnici



## Kuadra 1322/F



SEAT Sedile	BACK Schienale	FRAME Telaio	POWDER COATED Verniciato	CHROMED Cromato	SATINIZED Satinato
F01+F09	F01+F09	20x20 H650	€ 303,00	€ 319,00	€ 359,00
F11+F19	F11+F19		€ 218,00	€ 234,00	€ 262,00

For fabrics see page 367  
Per i tessuti si veda a p. 367

### PACKING / Imballo



### TECHNICAL DETAILS / Dettagli tecnici



## Kuadra 1326/F



SEAT Sedile	BACK Schienale	FRAME Telaio	POWDER COATED Verniciato	CHROMED Cromato	SATINIZED Satinato
F01+F09	F01+F09	20x20 H800	€ 318,00	€ 333,00	€ 373,00
F11+F19	F11+F19		€ 242,00	€ 258,00	€ 282,00

For fabrics see page 367  
Per i tessuti si veda a p. 367

### PACKING / Imballo



### TECHNICAL DETAILS / Dettagli tecnici



For colours and finishes see at page 362  
Per colori e finiture vedere da pagina 362

## Kuadra 1332/F



SEAT Sedile	BACK Schienale	FRAME Telaio	POWDER COATED Verniciato	CHROMED Cromato	MATT CHROMED Cromato opaco
F01+F09	F01+F09	Ø 16 H670	€ 271,00	€ 271,00	€ 285,00
F11+F19	F11+F19		€ 195,00	€ 195,00	€ 209,00

For fabrics see page 367  
Per i tessuti si veda a p. 367

PACKING / Imballo



TECHNICAL DETAILS / Dettagli tecnici



## Kuadra 1336/F



SEAT Sedile	BACK Schienale	FRAME Telaio	POWDER COATED Verniciato	CHROMED Cromato	MATT CHROMED Cromato opaco
F01+F09	F01+F09	Ø 16 H770	€ 273,00	€ 273,00	€ 288,00
F11+F19	F11+F19		€ 197,00	€ 197,00	€ 212,00

For fabrics see page 367  
Per i tessuti si veda a p. 367

PACKING / Imballo



TECHNICAL DETAILS / Dettagli tecnici



## Kuadra 1122



SEAT Sedile	BACK Schienale	FRAME Telaio	POWDER COATED Verniciato	CHROMED Cromato	SATINIZED Satinato
A	A	20x20 H670	€ 233,00	€ 248,00	€ 272,00
C*	C*		€ 250,00	€ 266,00	€ 290,00
G	G		€ 304,00	€ 319,00	€ 344,00
H*	H*		€ 253,00	€ 269,00	€ 293,00
TC**	TC**		€ 233,00	€ 248,00	€ 272,00

\*\*TC = Minimum order 10 pcs each fabric colour  
TC = Ordine minimo 10 pz per colore/tessuto

\*Excluding / Escluso C36+C39, H140+H143

For fabrics see page 367  
Per i tessuti si veda a p. 367

PACKING / Imballo



TECHNICAL DETAILS / Dettagli tecnici



FABRIC REQUIRED / Fabbisogno tessuto  
1pc: Lin Mtrs 0,90 (h 1,40)

For colours and finishes see at page 362  
Per colori e finiture vedere da pagina 362

## Kuadra 1126



SEAT Sedile	BACK Schienale	FRAME Telaio	POWDER COATED Verniciato	CHROMED Cromato	SATINIZED Satinato
A	A	20x20 H820	€ 256,00	€ 272,00	€ 296,00
C*	C*		€ 274,00	€ 289,00	€ 313,00
G	G		€ 327,00	€ 343,00	€ 368,00
H*	H*		€ 277,00	€ 293,00	€ 317,00
TC**	TC**		€ 256,00	€ 272,00	€ 296,00

\*\*TC = Minimum order 10 pcs each fabric colour  
TC = Ordine minimo 10 pz per colore/tessuto

\*Excluding / Escluso C36+C39, H140+H143

For fabrics see page 367  
Per i tessuti si veda a p. 367

PACKING / Imballo



FABRIC REQUIRED / Fabbisogno tessuto  
1pc: Lin Mtrs 0,90 (h 1,40)

TECHNICAL DETAILS / Dettagli tecnici

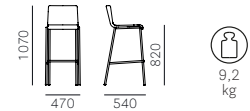

## Kuadra 1132



SEAT Sedile	BACK Schienale	FRAME Telaio	POWDER COATED Verniciato	CHROMED Cromato	MATT CHROMED Cromato opaco
A	A	Ø 16 H670	€ 198,00	€ 198,00	€ 212,00
C*	C*		€ 216,00	€ 216,00	€ 230,00
G	G		€ 269,00	€ 269,00	€ 284,00
H*	H*		€ 218,00	€ 218,00	€ 233,00
TC**	TC**		€ 198,00	€ 198,00	€ 212,00

\*\*TC = Minimum order 10 pcs each fabric colour  
TC = Ordine minimo 10 pz per colore/tessuto

\*Excluding / Escluso C36+C39, H140+H143

For fabrics see page 367  
Per i tessuti si veda a p. 367

PACKING / Imballo



FABRIC REQUIRED / Fabbisogno tessuto  
1pc: Lin Mtrs 0,90 (h 1,40)

TECHNICAL DETAILS / Dettagli tecnici

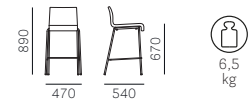

SAFETY, STRENGTH and DURABILITY TESTS  
Prove di sicurezza, resistenza e durata  
EN 1728:2012+AC2013  
EN 16139:2013 level 2

## Kuadra 1136



SEAT Sedile	BACK Schienale	FRAME Telaio	POWDER COATED Verniciato	CHROMED Cromato	MATT CHROMED Cromato opaco
A	A	Ø 16 H790	€ 200,00	€ 200,00	€ 215,00
C*	C*		€ 218,00	€ 218,00	€ 233,00
G	G		€ 272,00	€ 272,00	€ 286,00
H*	H*		€ 221,00	€ 221,00	€ 235,00
TC**	TC**		€ 200,00	€ 200,00	€ 215,00

\*\*TC = Minimum order 10 pcs each fabric colour  
TC = Ordine minimo 10 pz per colore/tessuto

\*Excluding / Escluso C36+C39, H140+H143

For fabrics see page 367  
Per i tessuti si veda a p. 367

PACKING / Imballo



FABRIC REQUIRED / Fabbisogno tessuto  
1pc: Lin Mtrs 0,90 (h 1,40)

TECHNICAL DETAILS / Dettagli tecnici

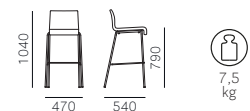

For colours and finishes see at page 362  
Per colori e finiture vedere da pagina 362

## Kuadra 4415/KUTP



SEAT Sedile	BACK Schienale	FRAME Telaio	POWDER COATED Verniciato	CHROMED Cromato	BRUSHED S/STEEL Inox satinato
TP	TP	Ø 400	€ 229,00	€ 264,00	€ 286,00

TP FINISHES / Finiture TP



PACKING / Imballo



TECHNICAL DETAILS / Dettagli tecnici

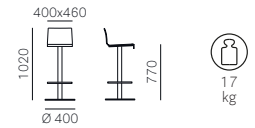

## Kuadra 4417/KU



SEAT Sedile	BACK Schienale	FRAME Telaio	POWDER COATED Verniciato	CHROMED Cromato	BRUSHED S/STEEL Inox satinato
RS-W-AN	RS-W-AN	Ø 450	€ 299,00	€ 333,00	€ 369,00
TC *	TC *		€ 310,00	€ 344,00	€ 381,00

\*Stained on sample: minimum order 20 pcs  
Tinta campione: ordine minimo 20pz

FINISHES / Finiture



PACKING / Imballo



TECHNICAL DETAILS / Dettagli tecnici

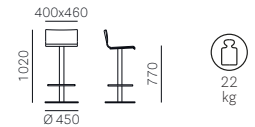

## Kuadra 4408



SEAT Sedile	BACK Schienale	FRAME Telaio	CHROMED Cromato	SATINIZED Satinato
RS-W-AN	RS-W-AN	400x400	€ 336,00	€ 336,00
TC *	TC *		€ 348,00	€ 348,00

\*Stained on sample: minimum order 20 pcs  
Tinta campione: ordine minimo 20pz

FINISHES / Finiture



PACKING / Imballo



TECHNICAL DETAILS / Dettagli tecnici

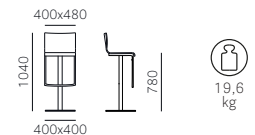

SAFETY, STRENGTH and DURABILITY TESTS  
Prove di sicurezza, resistenza e durata  
EN 1728:2000

For colours and finishes see at page 362  
Per colori e finiture vedere da pagina 362



## Kuadra 4429



SEAT Sedile	BACK Schienale	FRAME Telaio	SATINIZED Satinato
RS-W-AN	RS-W-AN	400x400	<b>€ 345,00</b>
TC *	TC *		<b>€ 356,00</b>

\*Stained on sample: minimum order 20 pcs  
Tinta campione: ordine minimo 20pz

### FINISHES / Finiture



### PACKING / Imballo



### TECHNICAL DETAILS / Dettagli tecnici

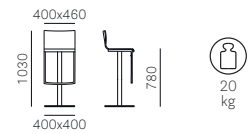

SAFETY, STRENGTH and DURABILITY TESTS  
Prove di sicurezza, resistenza e durata  
EN 1728:2000



## Kuadra 4408/F



SEAT Sedile	BACK Schienale	FRAME Telaio	CHROMED Cromato	SATINIZED Satinato
F01+F09	F01+F09	400x400	<b>€ 460,00</b>	<b>€ 460,00</b>
F11+F19	F11+F19		<b>€ 374,00</b>	<b>€ 374,00</b>

For fabrics see page 367  
Per i tessuti si veda a p. 367

### PACKING / Imballo



### TECHNICAL DETAILS / Dettagli tecnici

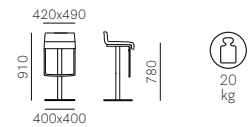

SAFETY, STRENGTH and DURABILITY TESTS  
Prove di sicurezza, resistenza e durata  
EN 1728:2000

## Kuadra 4427/F



SEAT Sedile	BACK Schienale	FRAME Telaio	SATINIZED Satinato
F01+F09	F01+F09	400x400	<b>€ 472,00</b>
F11+F19	F11+F19		<b>€ 381,00</b>

For fabrics see page 367  
Per i tessuti si veda a p. 367

### PACKING / Imballo



### TECHNICAL DETAILS / Dettagli tecnici

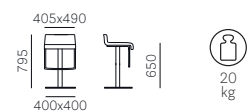

SAFETY, STRENGTH and DURABILITY TESTS  
Prove di sicurezza, resistenza e durata  
EN 1728:2000

## Kuadra 4429/F



SEAT Sedile	BACK Schienale	FRAME Telaio	SATINIZED Satinato
F01+F09	F01+F09	400x400	€ 475,00
F11+F19	F11+F19		€ 384,00

For fabrics see page 367  
Per i tessuti si veda a p. 367

PACKING / Imballo



TECHNICAL DETAILS / Dettagli tecnici

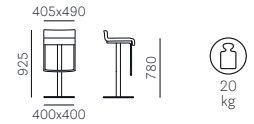

SAFETY, STRENGTH and DURABILITY TESTS  
Prove di sicurezza, resistenza e durata  
EN 1728:2000

## Kuadra XL 2401



SEAT Sedile	BACK Schienale	FRAME Telaio	POWDER COATED Verniciato	CHROMED Cromato	SATINIZED Satinato
BI	BI	20x20	€ 114,00	€ 134,00	€ 167,00
SA-NE	SA-NE		€ 132,00	€ 152,00	€ 185,00

TP FINISHES / Finiture TP



PACKING / Imballo



TECHNICAL DETAILS / Dettagli tecnici

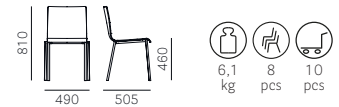

SAFETY, STRENGTH and DURABILITY TESTS  
Prove di sicurezza, resistenza e durata  
EN 1728:2000

## Kuadra XL 2403



SEAT Sedile	BACK Schienale	FRAME Telaio	POWDER COATED Verniciato	CHROMED Cromato
BI	BI	Ø 16	€ 85,00	€ 85,00
SA-NE	SA-NE		€ 104,00	€ 104,00

TP FINISHES / Finiture TP



PACKING / Imballo



TECHNICAL DETAILS / Dettagli tecnici



For colours and finishes see at page 362  
Per colori e finiture vedere da pagina 362



## Kuadra XL 2409



SEAT Sedile	BACK Schienale	FRAME Telaio	POWDER COATED Verniciato	CHROMED Cromato
BI	BI	Ø 10	€ 97,00	€ 90,00
SA-NE	SA-NE		€ 116,00	€ 109,00

TP FINISHES / Finiture TP



PACKING / Imballo



TECHNICAL DETAILS / Dettagli tecnici

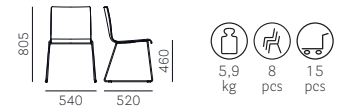

## Kuadra XL 2411



SEAT Sedile	BACK Schienale	FRAME Telaio	POWDER COATED Verniciato	CHROMED Cromato	SATINATED Satinato
RS-W-AN	RS-W-AN	20x20	€ 154,00	€ 172,00	€ 202,00
TC *	TC *		€ 165,00	€ 182,00	€ 213,00

\*Stained on sample: minimum order 20 pcs  
Tinta campione: ordine minimo 20 pz

FINISHES / Finiture



PACKING / Imballo



TECHNICAL DETAILS / Dettagli tecnici

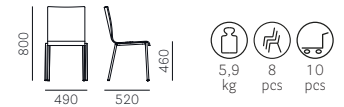

SAFETY, STRENGTH and DURABILITY TESTS  
Prove di sicurezza, resistenza e durata  
EN 1728:2000

## Kuadra XL 2413



SEAT Sedile	BACK Schienale	FRAME Telaio	POWDER COATED Verniciato	CHROMED Cromato
RS-W-AN	RS-W-AN	Ø 16	€ 131,00	€ 131,00
TC *	TC *		€ 142,00	€ 142,00

\*Stained on sample: minimum order 20 pcs  
Tinta campione: ordine minimo 20 pz

FINISHES / Finiture



PACKING / Imballo



TECHNICAL DETAILS / Dettagli tecnici



For colours and finishes see at page 362  
Per colori e finiture vedere da pagina 362

## Kuada XL 2411/A



SEAT Sedile	BACK Schienale	FRAME Telaio	POWDER COATED Verniciato	CHROMED Cromato	SATINIZED Satinato
A	RS-W-AN	20x20	€ 192,00	€ 210,00	€ 241,00
C **			€ 195,00	€ 213,00	€ 244,00
G			€ 211,00	€ 228,00	€ 259,00
H **			€ 196,00	€ 213,00	€ 244,00
P **			€ 215,00	€ 233,00	€ 263,00
TC ***			€ 192,00	€ 210,00	€ 241,00
CL ***			€ 199,00	€ 217,00	€ 247,00

\*\*\*TC/CL = Minimum order 10 pcs each fabric colour  
TC/CL = Ordine minimo 10 pz per colore/tessuto

\*\*Excluding / Escluso C36+C39, H140+H143, PBS-PCO-PMS-PVE

## FINISHES / Finiture



SAFETY, STRENGTH and DURABILITY TESTS  
Prove di sicurezza, resistenza e durata  
EN 1728:2000

\*Panel for stacking: surcharge € 25,00 (item IMPO2\_NE)  
Pannello per impilaggio: supplemento € 25,00 (art.IMPO2\_NE)

For fabrics see page 367  
Per i tessuti si veda a p. 367

## PACKING / Imballo



FABRIC REQUIRED / Fabbisogno tessuto  
1pc: Lin Mtrs 0,55 (h 1,40)

## TECHNICAL DETAILS / Dettagli tecnici



## Kuada XL 2413/A



SEAT Sedile	BACK Schienale	FRAME Telaio	POWDER COATED Verniciato	CHROMED Cromato
A	RS-W-AN	Ø 16	€ 170,00	€ 170,00
C **			€ 173,00	€ 173,00
G			€ 188,00	€ 188,00
H **			€ 173,00	€ 173,00
P **			€ 192,00	€ 192,00
TC ***			€ 170,00	€ 170,00
CL ***			€ 176,00	€ 176,00

\*\*\*TC/CL = Minimum order 10 pcs each fabric colour  
TC/CL = Ordine minimo 10 pz per colore/tessuto

\*\*Excluding / Escluso C36+C39, H140+H143, PBS-PCO-PMS-PVE

## FINISHES / Finiture



\*Panel for stacking: surcharge € 25,00 (item IMPO2\_NE)  
Pannello per impilaggio: supplemento € 25,00 (art.IMPO2\_NE)

For fabrics see page 367  
Per i tessuti si veda a p. 367

## PACKING / Imballo



FABRIC REQUIRED / Fabbisogno tessuto  
1pc: Lin Mtrs 0,55 (h 1,40)

## TECHNICAL DETAILS / Dettagli tecnici



## Kuada XL 2415

LAMINATO



SEAT Sedile	BACK Schienale	FRAME Telaio	POWDER COATED Verniciato	CHROMED Cromato	SATINIZED Satinato
NCS *	NCS *	20x20	€ 166,00	€ 184,00	€ 214,00

\*Minimum order 100 pcs  
Ordine minimo 100 pz

NCS COLOURS / COLORI NCS  
To be selected in ABET NCS colour card  
Da selezionare nella cartella colori ABET NCS

## PACKING / Imballo



## TECHNICAL DETAILS / Dettagli tecnici



For colours and finishes see at page 362  
Per colori e finiture vedere da pagina 362





## Kuadra XL 2417

LAMINATO



SEAT Sedile	BACK Schienale	FRAME Telaio	POWDER COATED Verniciato	CHROMED Cromato
NCS *	NCS *	Ø 16	€ 143,00	€ 143,00

\*Minimum order 100 pcs  
Ordine minimo 100 pz

NCS COLOURS / COLORI NCS  
To be selected in ABET NCS colour card  
Da selezionare nella cartella colori ABET NCS

PACKING / Imballo



TECHNICAL DETAILS / Dettagli tecnici

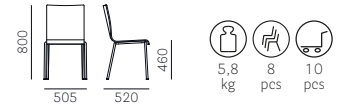

## Kuadra XL 2419



SEAT Sedile	BACK Schienale	FRAME Telaio	POWDER COATED Verniciato	CHROMED Cromato
RS-W-AN	RS-W-AN	Ø 10	€ 137,00	€ 131,00
TC *	TC *		€ 148,00	€ 142,00

\*Stained on sample: minimum order 20 pcs  
Tinta campione: ordine minimo 20 pz

FINISHES / Finiture



PACKING / Imballo



TECHNICAL DETAILS / Dettagli tecnici

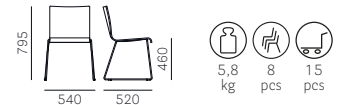

## Kuadra XL 2421



SEAT Sedile	BACK Schienale	FRAME Telaio	POWDER COATED Verniciato	CHROMED Cromato	SATINIZED Satinato
RS-W-AN	RS-W-AN	20x20	€ 154,00	€ 172,00	€ 202,00
TC *	TC *		€ 165,00	€ 182,00	€ 213,00

\*Stained on sample: minimum order 20 pcs  
Tinta campione: ordine minimo 20 pz

FINISHES / Finiture



PACKING / Imballo



TECHNICAL DETAILS / Dettagli tecnici



For colours and finishes see at page 362  
Per colori e finiture vedere da pagina 362

## Kuadra XL 2423



SEAT Sedile	BACK Schienale	FRAME Telaio	POWDER COATED Verniciato	CHROMED Cromato
RS-W-AN	RS-W-AN	Ø 16	€ 131,00	€ 131,00
TC *	TC *		€ 142,00	€ 142,00

\*Stained on sample: minimum order 20 pcs  
Tinta campione: ordine minimo 20 pz

FINISHES / Finiture



PACKING / Imballo



TECHNICAL DETAILS / Dettagli tecnici

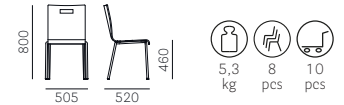

## Kuadra XL 2431



SEAT Sedile	BACK Schienale	FRAME Telaio	POWDER COATED Verniciato	CHROMED Cromato	SATINATED Satinato
RS-W-AN	RS-W-AN	20x20	€ 154,00	€ 172,00	€ 202,00
TC *	TC *		€ 165,00	€ 182,00	€ 213,00

\*Stained on sample: minimum order 20 pcs  
Tinta campione: ordine minimo 20 pz

FINISHES / Finiture



PACKING / Imballo



TECHNICAL DETAILS / Dettagli tecnici

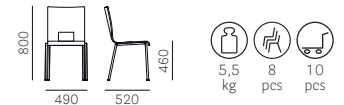

## Kuadra XL 2433



SEAT Sedile	BACK Schienale	FRAME Telaio	POWDER COATED Verniciato	CHROMED Cromato
RS-W-AN	RS-W-AN	Ø 16	€ 131,00	€ 131,00
TC *	TC *		€ 142,00	€ 142,00

\*Stained on sample: minimum order 20 pcs  
Tinta campione: ordine minimo 20 pz

FINISHES / Finiture



PACKING / Imballo



TECHNICAL DETAILS / Dettagli tecnici



For colours and finishes see at page 362  
Per colori e finiture vedere da pagina 362

## Kuadra XL 2441



SEAT Sedile	BACK Schienale	FRAME Telaio	POWDER COATED Verniciato	CHROMED Cromato	SATINIZED Satinato
A	A		€ 275,00	€ 293,00	€ 323,00
C **	C **		€ 294,00	€ 312,00	€ 343,00
G	G		€ 348,00	€ 365,00	€ 396,00
H **	H **	20x20	€ 299,00	€ 317,00	€ 348,00
P **	P **		€ 366,00	€ 384,00	€ 415,00
TC ***	TC ***		€ 275,00	€ 293,00	€ 323,00
CL ***	CL ***		€ 281,00	€ 299,00	€ 329,00

\*\*\*TC/CL = Minimum order 10 pcs each fabric colour  
TC/CL = Ordine minimo 10 pz per colore/tessuto

\*\*Excluding / Escluso C36+C39, H140+H143, PBS-PCO-PMS-PVE

## FINISHES / Finiture



SAFETY, STRENGTH and DURABILITY TESTS  
Prove di sicurezza, resistenza e durata  
EN 1728:2000

\*Panel for stacking: surcharge € 25,00 (item IMP02\_NE)  
Pannello per impilaggio: supplemento € 25,00 (art.IMP02\_NE)

For fabrics see page 367  
Per i tessuti si veda a p. 367

## PACKING / Imballo



FABRIC REQUIRED / Fabbisogno tessuto  
1pc: Lin Mtrs 0,55 (h 1,40)

## TECHNICAL DETAILS / Dettagli tecnici



## Kuadra XL 2443



SEAT Sedile	BACK Schienale	FRAME Telaio	POWDER COATED Verniciato	CHROMED Cromato
A	A		€ 252,00	€ 252,00
C **	C **		€ 272,00	€ 272,00
G	G		€ 325,00	€ 325,00
H **	H **	Ø 16	€ 277,00	€ 277,00
P **	P **		€ 344,00	€ 344,00
TC ***	TC ***		€ 252,00	€ 252,00
CL ***	CL ***		€ 258,00	€ 258,00

\*\*\*TC/CL = Minimum order 10 pcs each fabric colour  
TC/CL = Ordine minimo 10 pz per colore/tessuto

\*\*Excluding / Escluso C36+C39, H140+H143, PBS-PCO-PMS-PVE

## FINISHES / Finiture



\*Panel for stacking: surcharge € 25,00 (item IMP02\_NE)  
Pannello per impilaggio: supplemento € 25,00 (art.IMP02\_NE)

For fabrics see page 367  
Per i tessuti si veda a p. 367

## PACKING / Imballo



FABRIC REQUIRED / Fabbisogno tessuto  
1pc: Lin Mtrs 0,55 (h 1,40)

## TECHNICAL DETAILS / Dettagli tecnici



## Kuadra XL 2461



SEAT Sedile	BACK Schienale	FRAME Telaio	POWDER COATED Verniciato	CHROMED Cromato	SATINIZED Satinato
F01+F09	F01+F09		€ 300,00	€ 318,00	€ 349,00
F11+F19	F11+F19	20x20	€ 194,00	€ 211,00	€ 242,00

\*Panel for stacking: surcharge € 25,00 (item IMP02\_NE)  
Pannello per impilaggio: supplemento € 25,00 (art.IMP02\_NE)

For fabrics see page 367  
Per i tessuti si veda a p. 367

## PACKING / Imballo



## TECHNICAL DETAILS / Dettagli tecnici



For colours and finishes see at page 362  
Per colori e finiture vedere da pagina 362

## Kuadra XL 2463



SEAT Sedile	BACK Schienale	FRAME Telaio	POWDER COATED Verniciato	CHROMED Cromato
F01+F09	F01+F09	Ø 16	€ 274,00	€ 274,00
F11+F19	F11+F19		€ 167,00	€ 167,00

\*Panel for stacking: surcharge € 25,00 (item IMPO2\_NE)  
Pannello per impilaggio: supplemento € 25,00 (art.IMPO2\_NE)

For fabrics see page 367  
Per i tessuti si veda a p. 367

PACKING / Imballo



TECHNICAL DETAILS / Dettagli tecnici



## Kuadra XL 2481



SEAT Sedile	BACK Schienale	FRAME Telaio	POWDER COATED Verniciato	CHROMED Cromato	SATINIZED Satinato
A	A	20x20	€ 236,00	€ 253,00	€ 284,00
C**	C**		€ 257,00	€ 275,00	€ 306,00
G	G		€ 323,00	€ 340,00	€ 371,00
H**	H**		€ 262,00	€ 279,00	€ 310,00
TC***	TC***		€ 236,00	€ 253,00	€ 284,00

\*\*\*TC = Minimum order 10 pcs each fabric colour  
TC = Ordine minimo 10 pz per colore/tessuto

\*\*Excluding / Escluso C36+C39, H140+H143

\*Panel for stacking: surcharge € 25,00 (item IMPO2\_NE)  
Pannello per impilaggio: supplemento € 25,00 (art.IMPO2\_NE)

For fabrics see page 367  
Per i tessuti si veda a p. 367

PACKING / Imballo



TECHNICAL DETAILS / Dettagli tecnici



FABRIC REQUIRED / Fabbisogno tessuto  
1pc: Lin Mtrs 1,00 (h 1,40)

## Kuadra XL 2483



SEAT Sedile	BACK Schienale	FRAME Telaio	POWDER COATED Verniciato	CHROMED Cromato
A	A	Ø 16	€ 208,00	€ 208,00
C**	C**		€ 229,00	€ 229,00
G	G		€ 295,00	€ 295,00
H**	H**		€ 234,00	€ 234,00
TC***	TC***		€ 208,00	€ 208,00

\*\*\*TC = Minimum order 10 pcs each fabric colour  
TC = Ordine minimo 10 pz per colore/tessuto

\*\*Excluding / Escluso C36+C39, H140+H143

\*Panel for stacking: surcharge € 25,00 (item IMPO2\_NE)  
Pannello per impilaggio: supplemento € 25,00 (art.IMPO2\_NE)

For fabrics see page 367  
Per i tessuti si veda a p. 367

PACKING / Imballo



TECHNICAL DETAILS / Dettagli tecnici



FABRIC REQUIRED / Fabbisogno tessuto  
1pc: Lin Mtrs 1,00 (h 1,40)

For colours and finishes see at page 362  
Per colori e finiture vedere da pagina 362

## Kuadra XL 2491



SEAT Sedile	BACK Schienale	FRAME Telaio	POWDER COATED Verniciato	CHROMED Cromato	SATINIZED Satinato
A	A	20x20	€ 272,00	€ 290,00	€ 321,00
C **	C **		€ 294,00	€ 311,00	€ 342,00
G	G		€ 359,00	€ 377,00	€ 407,00
H **	H **		€ 298,00	€ 315,00	€ 346,00
TC ***	TC ***		€ 272,00	€ 290,00	€ 321,00

\*\*\*TC = Minimum order 10 pcs each fabric colour  
TC = Ordine minimo 10 pz per colore/tessuto

\*\*Excluding / Escluso C36+C39, H140+H143

\*Panel for stacking: surcharge € 25,00 (item IMP02\_NE)  
Pannello per impilaggio: supplemento € 25,00 (art.IMP02\_NE)

For fabrics see page 367  
Per i tessuti si veda a p. 367

PACKING / Imballo



FABRIC REQUIRED / Fabbisogno tessuto  
1pc: Lin Mtrs 1,00 (h 1,40)

TECHNICAL DETAILS / Dettagli tecnici



## Kuadra XL 2493



SEAT Sedile	BACK Schienale	FRAME Telaio	POWDER COATED Verniciato	CHROMED Cromato
A	A	Ø 16	€ 244,00	€ 244,00
C **	C **		€ 266,00	€ 266,00
G	G		€ 331,00	€ 331,00
H **	H **		€ 270,00	€ 270,00
TC ***	TC ***		€ 244,00	€ 244,00

\*\*\*TC = Minimum order 10 pcs each fabric colour  
TC = Ordine minimo 10 pz per colore/tessuto

\*\*Excluding / Escluso C36+C39, H140+H143

\*Panel for stacking: surcharge € 25,00 (item IMP02\_NE)  
Pannello per impilaggio: supplemento € 25,00 (art.IMP02\_NE)

For fabrics see page 367  
Per i tessuti si veda a p. 367

PACKING / Imballo



FABRIC REQUIRED / Fabbisogno tessuto  
1pc: Lin Mtrs 1,00 (h 1,40)

TECHNICAL DETAILS / Dettagli tecnici



## Kuadra XL 2402



SEAT Sedile	BACK Schienale	FRAME Telaio	POWDER COATED Verniciato	CHROMED Cromato	SATINIZED Satinato
BI	BI	20x20	€ 147,00	€ 167,00	€ 212,00
SA-NE	SA-NE		€ 165,00	€ 185,00	€ 230,00

TP FINISHES / Finiture TP



PACKING / Imballo



TECHNICAL DETAILS / Dettagli tecnici



For colours and finishes see at page 362  
Per colori e finiture vedere da pagina 362



## Kuadra XL 2404



SEAT Sedile	BACK Schienale	FRAME Telaio	POWDER COATED Verniciato	CHROMED Cromato
BI	BI	Ø 16	€ 125,00	€ 125,00
SA-NE	SA-NE		€ 132,00	€ 132,00

TP FINISHES / Finiture TP



PACKING / Imballo



TECHNICAL DETAILS / Dettagli tecnici



## Kuadra XL 2412



SEAT Sedile	BACK Schienale	FRAME Telaio	POWDER COATED Verniciato	CHROMED Cromato	SATINATED Satinato
RS-W-AN	RS-W-AN	20x20	€ 187,00	€ 206,00	€ 247,00
TC *	TC *		€ 198,00	€ 217,00	€ 258,00

\*Stained on sample: minimum order 20 pcs  
Tinta campione: ordine minimo 20 pz

FINISHES / Finiture



PACKING / Imballo



TECHNICAL DETAILS / Dettagli tecnici

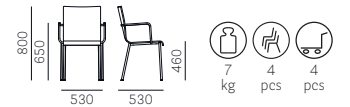

## Kuadra XL 2414



SEAT Sedile	BACK Schienale	FRAME Telaio	POWDER COATED Verniciato	CHROMED Cromato
RS-W-AN	RS-W-AN	Ø 16	€ 161,00	€ 161,00
TC *	TC *		€ 172,00	€ 172,00

\*Stained on sample: minimum order 20 pcs  
Tinta campione: ordine minimo 20 pz

FINISHES / Finiture



PACKING / Imballo



TECHNICAL DETAILS / Dettagli tecnici

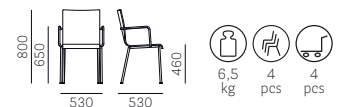

For colours and finishes see at page 362  
Per colori e finiture vedere da pagina 362

## Kuadra XL 2412/A



SEAT Sedile	BACK Schienale	FRAME Telaio	POWDER COATED Verniciato	CHROMED Cromato	SATINIZED Satinato
A			€ 227,00	€ 245,00	€ 286,00
C **			€ 229,00	€ 248,00	€ 289,00
G			€ 244,00	€ 263,00	€ 304,00
H **	RS-W-AN	20x20	€ 230,00	€ 249,00	€ 290,00
P **			€ 249,00	€ 267,00	€ 308,00
TC ***			€ 227,00	€ 245,00	€ 286,00
CL ***			€ 233,00	€ 252,00	€ 293,00

\*\*\*TC/CL = Minimum order 10 pcs each fabric colour  
TC/CL = Ordine minimo 10 pz per colore/tessuto

\*\*Excluding / Escluso C36+C39, H140+H143, PBS-PCO-PMS-PVE

## FINISHES / Finiture



RS

W

AN

\*Panel for stacking: surcharge € 25,00 (item IMP02\_NE)  
Pannello per impilaggio: supplemento € 25,00 (art.IMP02\_NE)

For fabrics see page 367  
Per i tessuti si veda a p. 367

## PACKING / Imballo



FABRIC REQUIRED / Fabbisogno tessuto  
1pc: Lin Mtrs 0,55 (h 1,40)

## TECHNICAL DETAILS / Dettagli tecnici

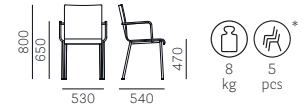

## Kuadra XL 2414/A



SEAT Sedile	BACK Schienale	FRAME Telaio	POWDER COATED Verniciato	CHROMED Cromato
A			€ 199,00	€ 199,00
C **			€ 202,00	€ 202,00
G			€ 217,00	€ 217,00
H **	RS-W-AN	Ø 16	€ 202,00	€ 202,00
P **			€ 222,00	€ 222,00
TC ***			€ 199,00	€ 199,00
CL ***			€ 206,00	€ 206,00

\*\*\*TC/CL = Minimum order 10 pcs each fabric colour  
TC/CL = Ordine minimo 10 pz per colore/tessuto

\*\*Excluding / Escluso C36+C39, H140+H143, PBS-PCO-PMS-PVE

## FINISHES / Finiture



RS

W

AN

\*Panel for stacking: surcharge € 25,00 (item IMP02\_NE)  
Pannello per impilaggio: supplemento € 25,00 (art.IMP02\_NE)

For fabrics see page 367  
Per i tessuti si veda a p. 367

## PACKING / Imballo



FABRIC REQUIRED / Fabbisogno tessuto  
1pc: Lin Mtrs 0,55 (h 1,40)

## TECHNICAL DETAILS / Dettagli tecnici



## Kuadra XL 2416

LAMINATO



SEAT Sedile	BACK Schienale	FRAME Telaio	POWDER COATED Verniciato	CHROMED Cromato	SATINIZED Satinato
NCS *	NCS *	20x20	€ 200,00	€ 218,00	€ 260,00

\*Minimum order 100 pcs  
Ordine minimo 100 pz

NCS COLOURS / COLORI NCS  
To be selected in ABET NCS colour card  
Da selezionare nella cartella colori ABET NCS

## PACKING / Imballo



## TECHNICAL DETAILS / Dettagli tecnici



For colours and finishes see at page 362  
Per colori e finiture vedere da pagina 362



## Kuadra XL 2418

LAMINATO



SEAT Sedile	BACK Schienale	FRAME Telaio	POWDER COATED Verniciato	CHROMED Cromato
NCS *	NCS *	Ø 16	€ 173,00	€ 173,00

\*Minimum order 100 pcs  
Ordine minimo 100 pz

NCS COLOURS / COLORI NCS  
To be selected in ABET NCS colour card  
Da selezionare nella cartella colori ABET NCS

PACKING / Imballo



TECHNICAL DETAILS / Dettagli tecnici

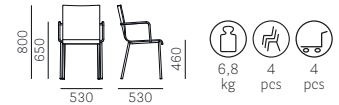

## Kuadra XL 2442



SEAT Sedile	BACK Schienale	FRAME Telaio	POWDER COATED Verniciato	CHROMED Cromato	SATINIZED Satinato
A	A	20x20	€ 308,00	€ 327,00	€ 368,00
C **	C **		€ 328,00	€ 347,00	€ 388,00
G	G		€ 381,00	€ 400,00	€ 441,00
H **	H **		€ 333,00	€ 351,00	€ 393,00
P **	P **		€ 400,00	€ 419,00	€ 460,00
TC ***	TC ***		€ 308,00	€ 327,00	€ 368,00
CL ***	CL ***		€ 315,00	€ 333,00	€ 374,00

\*\*\*TC/CL = Minimum order 10 pcs each fabric colour  
TC/CL = Ordine minimo 10 pz per colore/tessuto

\*\*Excluding / Escluso C36+C39, H140+H143, PBS-PCO-PMS-PVE

\*Panel for stacking: surcharge € 25,00 (item IMPO2\_NE)  
Pannello per impilaggio: supplemento € 25,00 (art.IMPO2\_NE)

For fabrics see page 367  
Per i tessuti si veda a p. 367

PACKING / Imballo



TECHNICAL DETAILS / Dettagli tecnici

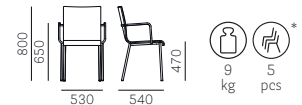

FINISHES / Finiture



## Kuadra XL 2444



SEAT Sedile	BACK Schienale	FRAME Telaio	POWDER COATED Verniciato	CHROMED Cromato
A	A	Ø 16	€ 282,00	€ 282,00
C **	C **		€ 301,00	€ 301,00
G	G		€ 354,00	€ 354,00
H **	H **		€ 306,00	€ 306,00
P **	P **		€ 373,00	€ 373,00
TC ***	TC ***		€ 282,00	€ 282,00
CL ***	CL ***		€ 288,00	€ 288,00

\*\*\*TC/CL = Minimum order 10 pcs each fabric colour  
TC/CL = Ordine minimo 10 pz per colore/tessuto

\*\*Excluding / Escluso C36+C39, H140+H143, PBS-PCO-PMS-PVE

\*Panel for stacking: surcharge € 25,00 (item IMPO2\_NE)  
Pannello per impilaggio: supplemento € 25,00 (art.IMPO2\_NE)

For fabrics see page 367  
Per i tessuti si veda a p. 367

PACKING / Imballo



TECHNICAL DETAILS / Dettagli tecnici

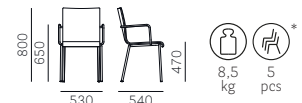

FINISHES / Finiture



For colours and finishes see at page 362  
Per colori e finiture vedere da pagina 362



## Kuadra XL 2462



SEAT Sedile	BACK Schienale	FRAME Telaio	POWDER COATED Verniciato	CHROMED Cromato	SATINIZED Satinato
F01+F09	F01+F09	20x20	€ 307,00	€ 326,00	€ 367,00
F11+F19	F11+F19		€ 220,00	€ 239,00	€ 280,00

\*Panel for stacking: surcharge € 25,00 (item IMPO2\_NE)  
Pannello per impilaggio: supplemento € 25,00 (art.IMPO2\_NE)

For fabrics see page 367  
Per i tessuti si veda a p. 367

PACKING / Imballo



TECHNICAL DETAILS / Dettagli tecnici



## Kuadra XL 2464



SEAT Sedile	BACK Schienale	FRAME Telaio	POWDER COATED Verniciato	CHROMED Cromato
F01+F09	F01+F09	Ø 16	€ 307,00	€ 307,00
F11+F19	F11+F19		€ 200,00	€ 200,00

\*Panel for stacking: surcharge € 25,00 (item IMPO2\_NE)  
Pannello per impilaggio: supplemento € 25,00 (art.IMPO2\_NE)

For fabrics see page 367  
Per i tessuti si veda a p. 367

PACKING / Imballo



TECHNICAL DETAILS / Dettagli tecnici



## Kuadra XL 2482



SEAT Sedile	BACK Schienale	FRAME Telaio	POWDER COATED Verniciato	CHROMED Cromato	SATINIZED Satinato
A	A	20x20	€ 263,00	€ 282,00	€ 323,00
C**	C**		€ 283,00	€ 301,00	€ 343,00
G	G		€ 348,00	€ 367,00	€ 408,00
H**	H**		€ 287,00	€ 306,00	€ 347,00
TC***	TC***		€ 263,00	€ 282,00	€ 323,00

\*\*\*TC = Minimum order 10 pcs each fabric colour  
TC = Ordine minimo 10 pz per colore/tessuto

\*\*Excluding / Escluso C36+C39, H140+H143

\*Panel for stacking: surcharge € 25,00 (item IMPO2\_NE)  
Pannello per impilaggio: supplemento € 25,00 (art.IMPO2\_NE)

For fabrics see page 367  
Per i tessuti si veda a p. 367

PACKING / Imballo



TECHNICAL DETAILS / Dettagli tecnici



FABRIC REQUIRED / Fabbisogno tessuto  
1 pc: Lin Mtrs 1,00 (h 1,40)

For colours and finishes see at page 362  
Per colori e finiture vedere da pagina 362

## Kuadra XL 2484



SEAT Sedile	BACK Schienale	FRAME Telaio	POWDER COATED Verniciato	CHROMED Cromato
A	A		€ 232,00	€ 232,00
C **	C **		€ 253,00	€ 253,00
G	G	Ø 16	€ 318,00	€ 318,00
H **	H **		€ 257,00	€ 257,00
TC ***	TC ***		€ 232,00	€ 232,00

\*\*\*TC = Minimum order 10 pcs each fabric colour  
TC = Ordine minimo 10 pz per colore/tessuto

\*\*Excluding / Escluso C36+C39, H140+H143

\*Panel for stacking: surcharge € 25,00 (item IMP02\_NE)  
Pannello per impilaggio: supplemento € 25,00 (art.IMP02\_NE)

For fabrics see page 367  
Per i tessuti si veda a p. 367

PACKING / Imballo



FABRIC REQUIRED / Fabbisogno tessuto  
1pc: Lin Mtrs 1,00 (h 1,40)

TECHNICAL DETAILS / Dettagli tecnici



## Kuadra XL 2492



SEAT Sedile	BACK Schienale	FRAME Telaio	POWDER COATED Verniciato	CHROMED Cromato	SATINIZED Satinato
A	A		€ 299,00	€ 318,00	€ 359,00
C **	C **		€ 319,00	€ 338,00	€ 379,00
G	G	20x20	€ 384,00	€ 403,00	€ 444,00
H **	H **		€ 323,00	€ 342,00	€ 383,00
TC ***	TC ***		€ 299,00	€ 318,00	€ 359,00

\*\*\*TC = Minimum order 10 pcs each fabric colour  
TC = Ordine minimo 10 pz per colore/tessuto

\*\*Excluding / Escluso C36+C39, H140+H143

\*Panel for stacking: surcharge € 25,00 (item IMP02\_NE)  
Pannello per impilaggio: supplemento € 25,00 (art.IMP02\_NE)

For fabrics see page 367  
Per i tessuti si veda a p. 367

PACKING / Imballo



FABRIC REQUIRED / Fabbisogno tessuto  
1pc: Lin Mtrs 1,00 (h 1,40)

TECHNICAL DETAILS / Dettagli tecnici



## Kuadra XL 2494



SEAT Sedile	BACK Schienale	FRAME Telaio	POWDER COATED Verniciato	CHROMED Cromato
A	A		€ 268,00	€ 268,00
C **	C **		€ 290,00	€ 290,00
G	G	Ø 16	€ 355,00	€ 355,00
H **	H **		€ 294,00	€ 294,00
TC ***	TC ***		€ 268,00	€ 268,00

\*\*\*TC = Minimum order 10 pcs each fabric colour  
TC = Ordine minimo 10 pz per colore/tessuto

\*\*Excluding / Escluso C36+C39, H140+H143

\*Panel for stacking: surcharge € 25,00 (item IMP02\_NE)  
Pannello per impilaggio: supplemento € 25,00 (art.IMP02\_NE)

For fabrics see page 367  
Per i tessuti si veda a p. 367

PACKING / Imballo



FABRIC REQUIRED / Fabbisogno tessuto  
1pc: Lin Mtrs 1,00 (h 1,40)

TECHNICAL DETAILS / Dettagli tecnici



For colours and finishes see at page 362  
Per colori e finiture vedere da pagina 362

## Kuadra XL 4429



SEAT Sedile	BACK Schienale	FRAME Telaio
A	A	400x400
C*	C*	
G	G	
H*	H*	
TC**	TC**	

**SATINIZED**  
Satinato

**€ 432,00**  
**€ 455,00**  
**€ 523,00**  
**€ 458,00**  
**€ 432,00**

\*\*TC = Minimum order 10 pcs each fabric colour  
TC = Ordine minimo 10 pz per colore/tessuto

\*Excluding / Escluso C36+C39, H140+H143

For fabrics see page 367  
Per i tessuti si veda a p. 367

**PACKING / Imballo**



**FABRIC REQUIRED / Fabbisogno tessuto**  
1pc: Lin Mtrs 0,80 (h 1,40)

**TECHNICAL DETAILS / Dettagli tecnici**

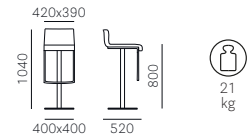

## Kuadra XL 2603



SEAT Sedile	BACK Schienale	FRAME Telaio
BI	BI	2x 400x400
SA-NE	SA-NE	

**BRUSHED S/STEEL**  
Inox satinato

**€ 740,00**  
**€ 795,00**

**TP FINISHES / Finiture TP**



**PACKING / Imballo**



**TECHNICAL DETAILS / Dettagli tecnici**

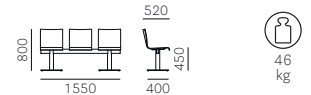

## Kuadra XL 2604



SEAT Sedile	BACK Schienale	FRAME Telaio
BI	BI	2x 400x400
SA-NE	SA-NE	

**BRUSHED S/STEEL**  
Inox satinato

**€ 872,00**  
**€ 946,00**

**TP FINISHES / Finiture TP**



**PACKING / Imballo**



**TECHNICAL DETAILS / Dettagli tecnici**



PRODUCT CERTIFIED  
FOR LOW CHEMICAL  
EMISSIONS:  
UL.COM/GG  
UL 2818



PRODUCT CERTIFIED  
FOR LOW CHEMICAL  
EMISSIONS:  
UL.COM/GG  
UL 2818

## Kuadra XL 2605

SEAT Sedile	BACK Schienale	FRAME Telaio	BRUSHED S/STEEL Inox satinato
BI	BI	2x 400x400	€ 1.004,00
SA-NE	SA-NE		€ 1.096,00



TP FINISHES / Finiture TP



PACKING / Imballo



TECHNICAL DETAILS / Dettagli tecnici

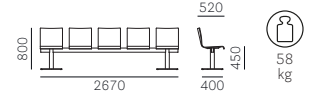

## Kuadra XL 2606

SEAT Sedile	BACK Schienale	FRAME Telaio	BRUSHED S/STEEL Inox satinato
BI	BI	2x 400x400	€ 911,00
SA-NE	SA-NE		€ 967,00



TP FINISHES / Finiture TP



TOP FINISHES / Finiture ripiano



COP\_BI COP\_NERO

PACKING / Imballo



TECHNICAL DETAILS / Dettagli tecnici



## Kuadra XL 2607

SEAT Sedile	BACK Schienale	FRAME Telaio	BRUSHED S/STEEL Inox satinato
BI	BI	2x 400x400	€ 1.043,00
SA-NE	SA-NE		€ 1.118,00



TP FINISHES / Finiture TP



TOP FINISHES / Finiture ripiano



COP\_BI COP\_NERO

PACKING / Imballo



TECHNICAL DETAILS / Dettagli tecnici

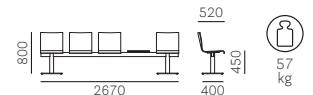

## Kuadra XL 2613



SEAT Sedile	BACK Schienale	FRAME Telaio
RS-W-AN	RS-W-AN	2x 400x400

BRUSHED S/STEEL  
Inox satinato

€ 787,00

FINISHES / Finiture



PACKING / Imballo



TECHNICAL DETAILS / Dettagli tecnici



## Kuadra XL 2614



SEAT Sedile	BACK Schienale	FRAME Telaio
RS-W-AN	RS-W-AN	2x 400x400

BRUSHED S/STEEL  
Inox satinato

€ 944,00

FINISHES / Finiture



PACKING / Imballo



TECHNICAL DETAILS / Dettagli tecnici

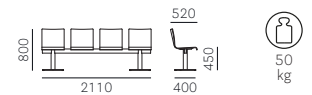

## Kuadra XL 2615



SEAT Sedile	BACK Schienale	FRAME Telaio
RS-W-AN	RS-W-AN	2x 400x400

BRUSHED S/STEEL  
Inox satinato

€ 1.102,00

FINISHES / Finiture



PACKING / Imballo



TECHNICAL DETAILS / Dettagli tecnici



## Kuadra XL 2616

SEAT Sedile	BACK Schienale	FRAME Telaio	BRUSHED S/STEEL Inox satinato
RS-W-AN	RS-W-AN	2x 400x400	<b>€ 944,00</b>



### WOODEN FINISHES / Finiture legno



### TOP FINISHES / Finiture ripiano



COP\_BI COP\_NERO

### PACKING / Imballo



### TECHNICAL DETAILS / Dettagli tecnici

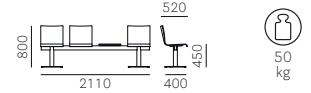

## Kuadra XL 2617

SEAT Sedile	BACK Schienale	FRAME Telaio	BRUSHED S/STEEL Inox satinato
RS-W-AN	RS-W-AN	2x 400x400	<b>€ 1.102,00</b>



### WOODEN FINISHES / Finiture legno



### TOP FINISHES / Finiture ripiano



COP\_BI COP\_NERO

### PACKING / Imballo



### TECHNICAL DETAILS / Dettagli tecnici



## Laja 883

WOOD



SEAT Sedile	BACK Schienale	FRAME Telaio	ASH Frassino
A	A	FR-N1-AN	€ 447,00
C*	C*		€ 481,00
G	G		€ 582,00
H*	H*		€ 487,00
P*	P*		€ 637,00
TC**	TC**		€ 447,00
CL**	CL**		€ 469,00

\*\*TC/CL = Minimum order 10 pcs each fabric colour  
TC/CL = Ordine minimo 10 pz per colore/tessuto

\*Excluding / Escluso C36+C39, H140+H143, PBS-PCO-PMS-PVE

## FINISHES / Finiture



Upcharge for double-colour upholstery (inner/outer) € 22,00  
Supplemento tappezzeria bicolore (fronte/retro) € 22,00

For fabrics see page 367  
Per i tessuti si veda a p. 367

## PACKING / Imballo



## FABRIC REQUIRED / Fabbisogno tessuto

1pc: Lin Mtrs 1,95 (h 1,40) outside/esterno  
1pc: Lin Mtrs 0,60 (h 1,40) inside/interno

## TECHNICAL DETAILS / Dettagli tecnici



## Laja 880



SEAT Sedile	BACK Schienale	POWDER COATED Verniciato	POLISHED ALUMINIUM Alluminio lucidato
A	A	€ 436,00	€ 458,00
C*	C*	€ 470,00	€ 492,00
G	G	€ 571,00	€ 593,00
H*	H*	€ 476,00	€ 498,00
P*	P*	€ 626,00	€ 648,00
TC**	TC**	€ 436,00	€ 458,00
CL**	CL**	€ 458,00	€ 480,00

\*\*TC/CL = Minimum order 10 pcs each fabric colour  
TC/CL = Ordine minimo 10 pz per colore/tessuto

\*Excluding / Escluso C36+C39, H140+H143, PBS-PCO-PMS-PVE

Upcharge for double-colour upholstery (inner/outer) € 22,00  
Supplemento tappezzeria bicolore (fronte/retro) € 22,00

For fabrics see page 367  
Per i tessuti si veda a p. 367

## PACKING / Imballo



## FABRIC REQUIRED / Fabbisogno tessuto

1pc: Lin Mtrs 1,95 (h 1,40) outside/esterno  
1pc: Lin Mtrs 0,60 (h 1,40) inside/interno

## TECHNICAL DETAILS / Dettagli tecnici



SAFETY, STRENGTH and DURABILITY TESTS  
Prove di sicurezza, resistenza e durata  
EN 1728:2000

## Laja 881



SEAT Sedile	BACK Schienale	FRAME Telaio	POWDER COATED Verniciato	CHROMED Cromato
A	A	Ø 12	€ 439,00	€ 439,00
C*	C*		€ 484,00	€ 484,00
G	G		€ 619,00	€ 619,00
H*	H*		€ 492,00	€ 492,00
P*	P*		€ 702,00	€ 702,00
TC**	TC**		€ 439,00	€ 439,00
CL**	CL**		€ 461,00	€ 461,00

\*\*TC/CL = Minimum order 10 pcs each fabric colour  
TC/CL = Ordine minimo 10 pz per colore/tessuto

\*Excluding / Escluso C36+C39, H140+H143, PBS-PCO-PMS-PVE

Upcharge for double-colour upholstery (inner/outer) € 22,00  
Supplemento tappezzeria bicolore (fronte/retro) € 22,00

For fabrics see page 367  
Per i tessuti si veda a p. 367

## PACKING / Imballo



## FABRIC REQUIRED / Fabbisogno tessuto

1pc: Lin Mtrs 1,95 (h 1,40) outside/esterno  
1pc: Lin Mtrs 0,60 (h 1,40) inside/interno

## TECHNICAL DETAILS / Dettagli tecnici

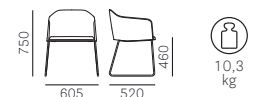

For colours and finishes see at page 362  
Per colori e finiture vedere da pagina 362

## Laja 882

CANTILEVER



SEAT Sedile	BACK Schienale	FRAME Telaio	POWDER COATED Verniciato	CHROMED Cromato
A	A		€ 478,00	€ 500,00
C*	C*		€ 522,00	€ 544,00
G	G		€ 657,00	€ 679,00
H*	H*	Ø 25	€ 531,00	€ 553,00
P*	P*		€ 741,00	€ 763,00
TC**	TC**		€ 478,00	€ 500,00
CL**	CL**		€ 500,00	€ 522,00

\*\*TC/CL = Minimum order 10 pcs each fabric colour  
TC/CL = Ordine minimo 10 pz per colore/tessuto

\*Excluding / Escluso C36+C39, H140+H143, PBS-PCO-PMS-PVE

Upcharge for double-colour upholstery (inner/outer) € 22,00  
Supplemento tappezzeria bicolore (fronte/retro) € 22,00

For fabrics see page 367  
Per i tessuti si veda a p. 367

PACKING / Imballo

TECHNICAL DETAILS / Dettagli tecnici



FABRIC REQUIRED / Fabbisogno tessuto

1pc: Lin Mtrs 1,95 (h 1,40) outside/esterno  
1pc: Lin Mtrs 0,60 (h 1,40) inside/interno

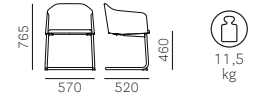

### SAFETY, STRENGTH and DURABILITY TESTS

Prove di sicurezza, resistenza e durata

EN 1728:2012+AC2013

EN 16139:2013 level 2

## Laja 884

WOOD



SEAT Sedile	BACK Schienale	FRAME Telaio	ASH Frassino
A	A		€ 489,00
C*	C*		€ 533,00
G	G		€ 668,00
H*	H*	FR-N1-AN	€ 542,00
P*	P*		€ 752,00
TC**	TC**		€ 489,00
CL**	CL**		€ 511,00

\*\*TC/CL = Minimum order 10 pcs each fabric colour  
TC/CL = Ordine minimo 10 pz per colore/tessuto

\*Excluding / Escluso C36+C39, H140+H143, PBS-PCO-PMS-PVE

Upcharge for double-colour upholstery (inner/outer) € 22,00  
Supplemento tappezzeria bicolore (fronte/retro) € 22,00

For fabrics see page 367  
Per i tessuti si veda a p. 367

PACKING / Imballo

TECHNICAL DETAILS / Dettagli tecnici



FABRIC REQUIRED / Fabbisogno tessuto

1pc: Lin Mtrs 1,95 (h 1,40) outside/esterno  
1pc: Lin Mtrs 0,60 (h 1,40) inside/interno



### SAFETY, STRENGTH and DURABILITY TESTS

Prove di sicurezza, resistenza e durata

EN 1728:2000

FINISHES / Finiture

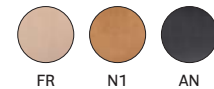

## Laja 884T

WOOD



SEAT Sedile	BACK Schienale	FRAME Telaio	ASH Frassino
A	A		€ 584,00
C*	C*		€ 628,00
G	G		€ 763,00
H*	H*	FR-N1-AN	€ 637,00
P*	P*		€ 847,00
TC**	TC**		€ 584,00
CL**	CL**		€ 606,00

\*\*TC/CL = Minimum order 10 pcs each fabric colour  
TC/CL = Ordine minimo 10 pz per colore/tessuto

\*Excluding / Escluso C36+C39, H140+H143, PBS-PCO-PMS-PVE

Upcharge for double-colour upholstery (inner/outer) € 22,00  
Supplemento tappezzeria bicolore (fronte/retro) € 22,00

For fabrics see page 367  
Per i tessuti si veda a p. 367

PACKING / Imballo

TECHNICAL DETAILS / Dettagli tecnici



FABRIC REQUIRED / Fabbisogno tessuto

1pc: Lin Mtrs 1,95 (h 1,40) outside/esterno  
1pc: Lin Mtrs 0,60 (h 1,40) inside/interno



FINISHES / Finiture



TABLET FINISHES / Finiture tavoletta

Anti-fingerprint finish  
Finitura anti-impronta

FNP\_NE

For colours and finishes see at page 362  
Per colori e finiture vedere da pagina 362





## Laja 884/TT

Turning tablet only  
Solo tavoletta girevole



TOP  
Ripiano

€ 95,00

Black powder coated armrest Ø11 mm  
Bracciolo in tondino Ø11 mm verniciato nero

For item / Per articolo  
884

### TABLET FINISHES / Finiture tavoletta

Anti-fingerprint finish  
Finitura anti-impronta

FNP\_NE

### PACKING / Imballo

2 pcs MC 0,014

### TECHNICAL DETAILS / Dettagli tecnici

265 300  
200  
1 kg

## Laja 885



SEAT Sedile	BACK Schienale	POWDER COATED Verniciato	POLISHED ALUMINIUM Alluminio lucidato
A	A	€ 478,00	€ 500,00
C*	C*	€ 522,00	€ 544,00
G	G	€ 657,00	€ 679,00
H*	H*	€ 531,00	€ 553,00
P*	P*	€ 741,00	€ 763,00
TC**	TC**	€ 478,00	€ 500,00
CL**	CL**	€ 500,00	€ 522,00

\*\*TC/CL = Minimum order 10 pcs each fabric colour  
TC/CL = Ordine minimo 10 pz per colore/tessuto

\*Excluding / Escluso C36+C39, H140+H143, PBS-PCO-PMS-PVE

Upcharge for double-colour upholstery (inner/outer) € 22,00  
Supplemento tappezzeria bicolore (fronte/retro) € 22,00

For fabrics see page 367  
Per i tessuti si veda a p. 367

### PACKING / Imballo

1 pc MC 0,295

### TECHNICAL DETAILS / Dettagli tecnici

760 660 460  
585 530  
9,2 kg

SAFETY, STRENGTH and DURABILITY TESTS  
Prove di sicurezza, resistenza e durata  
EN 1728:2000

FABRIC REQUIRED / Fabbisogno tessuto  
1pc: Lin Mtrs 1,95 (h 1,40) outside/esterno  
1pc: Lin Mtrs 0,60 (h 1,40) inside/interno

## Laja 886



SEAT Sedile	BACK Schienale	FRAME Telaio	WHITE/BLACK POWDER COATED Verniciato bianco/nero	POLISHED ALUMINIUM Alluminio lucidato
A	A		€ 566,00	€ 599,00
C*	C*		€ 610,00	€ 643,00
G	G		€ 745,00	€ 778,00
H*	H*	Ø 680	€ 619,00	€ 652,00
P*	P*		€ 829,00	€ 862,00
TC**	TC**		€ 566,00	€ 599,00
CL**	CL**		€ 588,00	€ 621,00

\*\*TC/CL = Minimum order 10 pcs each fabric colour  
TC/CL = Ordine minimo 10 pz per colore/tessuto

\*Excluding / Escluso C36+C39, H140+H143, PBS-PCO-PMS-PVE

Upcharge for double-colour upholstery (inner/outer) € 22,00  
Supplemento tappezzeria bicolore (fronte/retro) € 22,00

For fabrics see page 367  
Per i tessuti si veda a p. 367

### PACKING / Imballo

1 pc KD  
MC 0,189

### TECHNICAL DETAILS / Dettagli tecnici

760 660 460  
560 520  
11,7 kg

For colours and finishes see at page 362  
Per colori e finiture vedere da pagina 362

FABRIC REQUIRED / Fabbisogno tessuto  
1pc: Lin Mtrs 1,95 (h 1,40) outside/esterno  
1pc: Lin Mtrs 0,60 (h 1,40) inside/interno

## Laja 887



SEAT Sedile	BACK Schienale	FRAME Telaio	WHITE/BLACK POWDER COATED Verniciato bianco/nero	POLISHED ALUMINIUM Alluminio lucidato
A	A		€ 588,00	€ 621,00
C*	C*		€ 632,00	€ 665,00
G	G		€ 767,00	€ 800,00
H*	H*	Ø 680	€ 641,00	€ 674,00
P*	P*		€ 851,00	€ 884,00
TC**	TC**		€ 588,00	€ 621,00
CL**	CL**		€ 610,00	€ 643,00

\*\*TC/CL = Minimum order 10 pcs each fabric colour  
TC/CL = Ordine minimo 10 pz per colore/tessuto

\*Excluding / Escluso C36+C39, H140+H143, PBS-PCO-PMS-PVE

Upcharge for double-colour upholstery (inner/outer) € 22,00  
Supplemento tappezzeria bicolore (fronte/retro) € 22,00

For fabrics see page 367  
Per i tessuti si veda a p. 367

PACKING / Imballo

TECHNICAL DETAILS / Dettagli tecnici



FABRIC REQUIRED / Fabbisogno tessuto

1pc: Lin Mtrs 1,95 (h 1,40) outside/esterno  
1pc: Lin Mtrs 0,60 (h 1,40) inside/interno



## Laja 889G

WINGS



SEAT Sedile	BACK Schienale	FRAME Telaio	FABRIC Tessuto
A	A	A	€ 769,00
C*	C*	C*	€ 829,00
G	G	G	€ 968,00
H*	H*	H*	€ 840,00
P*	P*	P*	€ 1.209,00
TC**	TC**	TC**	€ 769,00
CL**	CL**	CL**	€ 791,00

\*\*TC/CL = Minimum order 10 pcs each fabric colour  
TC/CL = Ordine minimo 10 pz per colore/tessuto

\*Excluding / Escluso C36+C39, H140+H143, PBS-PCO-PMS-PVE

Upcharge for double-colour upholstery (inner/outer) € 22,00  
Supplemento tappezzeria bicolore (fronte/retro) € 22,00

For fabrics see page 367  
Per i tessuti si veda a p. 367

PACKING / Imballo

TECHNICAL DETAILS / Dettagli tecnici



FABRIC REQUIRED / Fabbisogno tessuto

1pc: Lin Mtrs 1,90 (h 1,40) outside/esterno  
1pc: Lin Mtrs 1,50 (h 1,40) inside/interno



SAFETY, STRENGTH and DURABILITY TESTS  
Prove di sicurezza, resistenza e durata  
EN 1728:2012+AC2013  
EN 16139:2013 level 2

## Laja 889F

WINGS



SEAT Sedile	BACK Schienale	FRAME Telaio	FABRIC Tessuto
A	A	A	€ 736,00
C*	C*	C*	€ 796,00
G	G	G	€ 913,00
H*	H*	H*	€ 807,00
P*	P*	P*	€ 1.176,00
TC**	TC**	TC**	€ 736,00
CL**	CL**	CL**	€ 758,00

\*\*TC/CL = Minimum order 10 pcs each fabric colour  
TC/CL = Ordine minimo 10 pz per colore/tessuto

\*Excluding / Escluso C36+C39, H140+H143, PBS-PCO-PMS-PVE

Upcharge for double-colour upholstery (inner/outer) € 22,00  
Supplemento tappezzeria bicolore (fronte/retro) € 22,00

For fabrics see page 367  
Per i tessuti si veda a p. 367

PACKING / Imballo

TECHNICAL DETAILS / Dettagli tecnici



FABRIC REQUIRED / Fabbisogno tessuto

1pc: Lin Mtrs 1,90 (h 1,40) outside/esterno  
1pc: Lin Mtrs 1,50 (h 1,40) inside/interno



SAFETY, STRENGTH and DURABILITY TESTS  
Prove di sicurezza, resistenza e durata  
EN 1728:2012+AC2013  
EN 16139:2013 level 2

## Lamorisse 3684



SEAT Sedile	BACK Schienale	FRAME Telaio
D22+D26 D80+D89 D100+D105 D110+D115 D130+D133	D22+D26 D80+D89 D100+D105 D110+D115 D130+D133	METAL

POWDER COATED  
Verniciato

€ 650,00

For fabrics see page 367  
Per i tessuti si veda a p. 367

FINISHES / Finiture



BI200E SA200E TEE AR400E VE600E

PACKING / Imballo



TECHNICAL DETAILS / Dettagli tecnici



SAFETY, STRENGTH and DURABILITY TESTS  
Prove di sicurezza, resistenza e durata  
EN 1728:2012+AC2013  
EN 16139:2013 level 2

## Lamorisse 3685



SEAT Sedile	BACK Schienale	FRAME Telaio
D22+D26 D80+D89 D100+D105 D110+D115 D130+D133	D22+D26 D80+D89 D100+D105 D110+D115 D130+D133	METAL

POWDER COATED  
Verniciato

€ 890,00

For fabrics see page 367  
Per i tessuti si veda a p. 367

FINISHES / Finiture



BI200E SA200E TEE AR400E VE600E

PACKING / Imballo



TECHNICAL DETAILS / Dettagli tecnici



SAFETY, STRENGTH and DURABILITY TESTS  
Prove di sicurezza, resistenza e durata  
EN 1728:2012+AC2013  
EN 16139:2013 level 2

## Leila 681



SEAT Sedile	BACK Schienale	FRAME Telaio
A	A	
C*	C*	
G	G	RS-W-N1- GC-BI
H*	H*	
P*	P*	TC
TC**	TC**	
CL**	CL**	

OAK  
Rovere

€ 541,00  
€ 586,00  
€ 707,00  
€ 593,00  
€ 829,00  
€ 541,00  
€ 565,00

OAK STAINED ON SAMPLE  
Rovere tinto campione

€ 565,00  
€ 610,00  
€ 731,00  
€ 618,00  
€ 854,00  
€ 565,00  
€ 589,00

\*\*TC/CL = Minimum order 10 pcs each fabric colour  
TC/CL = Ordine minimo 10 pz per colore/tessuto

\*Excluding / Escluso C36+C39, H140+H143, PBS-PCO-PMS-PVE

FINISHES / Finiture



RS W N1 GC BI

For fabrics see page 367  
Per i tessuti si veda a p. 367

PACKING / Imballo



TECHNICAL DETAILS / Dettagli tecnici

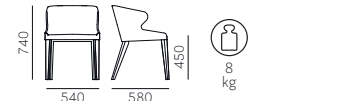

SAFETY, STRENGTH and DURABILITY TESTS  
Prove di sicurezza, resistenza e durata  
EN 1728:2000

FABRIC REQUIRED / Fabbisogno tessuto  
1 pc: Lin Mtrs 1,40 (h 1,40)

## Leila 682



SEAT Sedile	BACK Schienale	FRAME Telaio	CHROMED Cromato	SATINIZED Satinato
A	A		€ 468,00	€ 492,00
C*	C*		€ 514,00	€ 538,00
G	G		€ 635,00	€ 659,00
H*	H*	Ø 16	€ 521,00	€ 545,00
P*	P*		€ 757,00	€ 781,00
TC**	TC**		€ 468,00	€ 492,00
CL**	CL**		€ 492,00	€ 516,00

\*\*TC/CL = Minimum order 10 pcs each fabric colour  
TC/CL = Ordine minimo 10 pz per colore/tessuto

\*Excluding / Escluso C36+C39, H140+H143, PBS-PCO-PMS-PVE

For fabrics see page 367  
Per i tessuti si veda a p. 367

PACKING / Imballo



FABRIC REQUIRED / Fabbisogno tessuto  
1pc: Lin Mtrs 1,40 (h 1,40)

TECHNICAL DETAILS / Dettagli tecnici

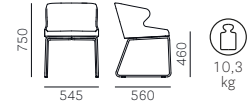

## Leila 683



SEAT Sedile	BACK Schienale	FRAME Telaio	BRUSHED S/STEEL Inox satinato	POLISHED S/STEEL Inox lucidato
A	A		€ 541,00	€ 553,00
C*	C*		€ 586,00	€ 598,00
G	G		€ 707,00	€ 719,00
H*	H*	Ø 450	€ 593,00	€ 605,00
P*	P*		€ 829,00	€ 841,00
TC**	TC**		€ 541,00	€ 553,00
CL**	CL**		€ 565,00	€ 577,00

\*\*TC/CL = Minimum order 10 pcs each fabric colour  
TC/CL = Ordine minimo 10 pz per colore/tessuto

\*Excluding / Escluso C36+C39, H140+H143, PBS-PCO-PMS-PVE

For fabrics see page 367  
Per i tessuti si veda a p. 367

PACKING / Imballo



FABRIC REQUIRED / Fabbisogno tessuto  
1pc: Lin Mtrs 1,40 (h 1,40)

TECHNICAL DETAILS / Dettagli tecnici

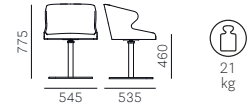

## Leila 687



SEAT Sedile	BACK Schienale	FRAME Telaio	CHROMED Cromato	BRUSHED S/STEEL Inox satinato
A	A		€ 632,00	€ 662,00
C*	C*		€ 664,00	€ 693,00
G	G		€ 814,00	€ 844,00
H*	H*	400x400 H650	€ 685,00	€ 714,00
P*	P*		€ 862,00	€ 892,00
TC**	TC**		€ 632,00	€ 662,00
CL**	CL**		€ 644,00	€ 674,00

\*\*TC/CL = Minimum order 10 pcs each fabric colour  
TC/CL = Ordine minimo 10 pz per colore/tessuto

\*Excluding / Escluso C36+C39, H140+H143, PBS-PCO-PMS-PVE

For fabrics see page 367  
Per i tessuti si veda a p. 367

PACKING / Imballo



FABRIC REQUIRED / Fabbisogno tessuto  
1pc: Lin Mtrs 1,40 (h 1,40)

TECHNICAL DETAILS / Dettagli tecnici

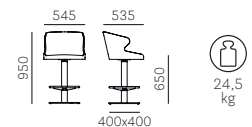

## Log 365



SEAT Sedile	BACK Schienale	FRAME Telaio
C*	C*	C*
D40÷D44 D120÷D123	D40÷D44 D120÷D123	D40÷D44 D120÷D123
E	E	E
G	G	G
H	H	H
N	N	N

\*Excluding / Escluso C36+C39

FABRIC  
Tessuto

€ 585,00  
€ 678,00  
€ 696,00  
€ 696,00  
€ 593,00  
€ 829,00

For fabrics see page 367  
Per i tessuti si veda a p. 367

PACKING / Imballo



TECHNICAL DETAILS / Dettagli tecnici

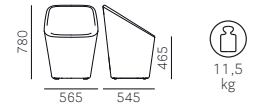

SAFETY, STRENGTH and DURABILITY TESTS  
Prove di sicurezza, resistenza e durata  
EN 1728:2012+AC2013  
EN 16139:2013 level 2

## Log 366

LOUNGE



SEAT Sedile	BACK Schienale	FRAME Telaio
C*	C*	C*
D40÷D44 D120÷D123	D40÷D44 D120÷D123	D40÷D44 D120÷D123
E	E	E
G	G	G
H	H	H
N	N	N

\*Excluding / Escluso C36+C39

FABRIC  
Tessuto

€ 777,00  
€ 852,00  
€ 1.001,00  
€ 1.001,00  
€ 791,00  
€ 1.062,00

For fabrics see page 367  
Per i tessuti si veda a p. 367

PACKING / Imballo



TECHNICAL DETAILS / Dettagli tecnici

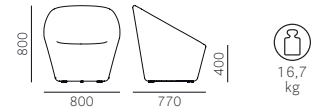

## Log 367

POUF



SEAT Sedile	FRAME Telaio
C*	C*
D40÷D44 D120÷D123	D40÷D44 D120÷D123
E	E
G	G
H	H
N	N

\*Excluding / Escluso C36+C39

FABRIC  
Tessuto

€ 409,00  
€ 445,00  
€ 516,00  
€ 516,00  
€ 415,00  
€ 548,00

For fabrics see page 367  
Per i tessuti si veda a p. 367

PACKING / Imballo



TECHNICAL DETAILS / Dettagli tecnici



## Log 368

SOFA



SEAT Sedile	BACK Schienale	FRAME Telaio	FABRIC Tessuto
C*	C*	C*	€ 1.292,00
D40+D44 D120+D123	D40+D44 D120+D123	D40+D44 D120+D123	€ 1.424,00
E	E	E	€ 1.625,00
G	G	G	€ 1.625,00
H	H	H	€ 1.338,00
N	N	N	€ 1.721,00

\*Excluding / Escluso C36+C39

For fabrics see page 367  
Per i tessuti si veda a p. 367

PACKING / Imballo



TECHNICAL DETAILS / Dettagli tecnici

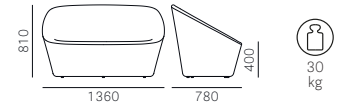

## Lotus 4415F

S\_TX



SEAT Sedile	FRAME Telaio	POWDER COATED Verniciato	CHROMED Cromato	BRUSHED S/STEEL Inox satinato
Frame only / Solo telaio		€ 162,00	€ 200,00	€ 225,00
A		€ 205,00	€ 243,00	€ 268,00
C*		€ 217,00	€ 255,00	€ 280,00
G		€ 251,00	€ 289,00	€ 314,00
H*	Ø 400	€ 219,00	€ 257,00	€ 282,00
P*		€ 263,00	€ 301,00	€ 326,00
TC**		€ 205,00	€ 243,00	€ 268,00
CL**		€ 211,00	€ 249,00	€ 274,00
PG		€ 184,00	€ 222,00	€ 247,00

\*\*TC/CL = Minimum order 10 pcs each fabric colour  
TC/CL = Ordine minimo 10 pz per colore/tessuto

\*Excluding / Escluso C36+C39, H140+H143, PBS-PCO-PMS-PVE

For fabrics see page 367  
Per i tessuti si veda a p. 367

PACKING / Imballo

FABRIC REQUIRED / Fabbisogno tessuto  
1 pc: Lin Mtrs 0,35 (h 1,40)

TECHNICAL DETAILS / Dettagli tecnici

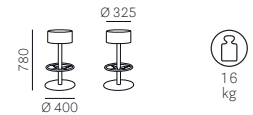

## Lotus 4415G

S\_TX



SEAT Sedile	FRAME Telaio	POWDER COATED Verniciato	CHROMED Cromato	BRUSHED S/STEEL Inox satinato
Frame only / Solo telaio		€ 201,00	€ 240,00	€ 265,00
A		€ 244,00	€ 283,00	€ 308,00
C*		€ 256,00	€ 295,00	€ 320,00
G		€ 290,00	€ 329,00	€ 354,00
H*	Ø 400	€ 258,00	€ 297,00	€ 322,00
P*		€ 302,00	€ 341,00	€ 366,00
TC**		€ 244,00	€ 283,00	€ 308,00
CL**		€ 250,00	€ 289,00	€ 314,00
PG		€ 223,00	€ 262,00	€ 287,00

\*\*TC/CL = Minimum order 10 pcs each fabric colour  
TC/CL = Ordine minimo 10 pz per colore/tessuto

\*Excluding / Escluso C36+C39, H140+H143, PBS-PCO-PMS-PVE

For fabrics see page 367  
Per i tessuti si veda a p. 367

PACKING / Imballo

FABRIC REQUIRED / Fabbisogno tessuto  
1 pc: Lin Mtrs 0,35 (h 1,40)

TECHNICAL DETAILS / Dettagli tecnici

For colours and finishes see at page 362  
Per colori e finiture vedere da pagina 362

## Lotus 4416

S\_TX



SEAT Sedile	FRAME Telaio	POWDER COATED Verniciato	CHROMED Cromato	BRUSHED S/STEEL Inox satinato
Frame only / Solo telaio		€ 174,00	€ 221,00	€ 257,00
A		€ 217,00	€ 264,00	€ 300,00
C*		€ 229,00	€ 276,00	€ 312,00
G		€ 263,00	€ 310,00	€ 346,00
H*	Ø 450	€ 231,00	€ 278,00	€ 314,00
P*		€ 275,00	€ 322,00	€ 358,00
TC**		€ 217,00	€ 264,00	€ 300,00
CL**		€ 223,00	€ 270,00	€ 306,00
PG		€ 196,00	€ 243,00	€ 279,00

\*\*TC/CL = Minimum order 10 pcs each fabric colour  
TC/CL = Ordine minimo 10 pz per colore/tessuto

\*Excluding / Escluso C36+C39, H140+H143, PBS-PCO-PMS-PVE

For fabrics see page 367  
Per i tessuti si veda a p. 367

PACKING / Imballo



FABRIC REQUIRED / Fabbisogno tessuto  
1pc: Lin Mtrs 0,35 (h 1,40)

TECHNICAL DETAILS / Dettagli tecnici

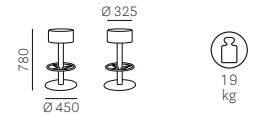

## Lotus 4417

S\_TX



SEAT Sedile	FRAME Telaio	POWDER COATED Verniciato	CHROMED Cromato	BRUSHED S/STEEL Inox satinato
Frame only / Solo telaio		€ 214,00	€ 261,00	€ 296,00
A		€ 257,00	€ 304,00	€ 339,00
C*		€ 269,00	€ 316,00	€ 351,00
G		€ 303,00	€ 350,00	€ 385,00
H*	Ø 450	€ 271,00	€ 318,00	€ 353,00
P*		€ 315,00	€ 362,00	€ 397,00
TC**		€ 257,00	€ 304,00	€ 339,00
CL**		€ 263,00	€ 310,00	€ 345,00
PG		€ 236,00	€ 283,00	€ 318,00

\*\*TC/CL = Minimum order 10 pcs each fabric colour  
TC/CL = Ordine minimo 10 pz per colore/tessuto

\*Excluding / Escluso C36+C39, H140+H143, PBS-PCO-PMS-PVE

For fabrics see page 367  
Per i tessuti si veda a p. 367

PACKING / Imballo



FABRIC REQUIRED / Fabbisogno tessuto  
1pc: Lin Mtrs 0,35 (h 1,40)

TECHNICAL DETAILS / Dettagli tecnici



## Malmö 390



SEAT Sedile	BACK Schienale	FRAME Telaio	ASH Frassino	ASH STAINED ON SAMPLE Frassino tinto campione
FR-N1-GC- BI-AN	FR-N1-GC- BI-AN	FR-N1-GC- BI-AN	€ 256,00	
TC	TC	TC		€ 280,00

Minimum order q.ty: 20 pcs  
Ordine minimo: 20pz

FINISHES / Finiture



PACKING / Imballo



TECHNICAL DETAILS / Dettagli tecnici



SAFETY, STRENGTH and DURABILITY TESTS  
Prove di sicurezza, resistenza e durata  
EN 1728:2012+AC2013  
EN 16139:2013 level 2

For colours and finishes see at page 362  
Per colori e finiture vedere da pagina 362



PRODUCT CERTIFIED  
FOR LOW CHEMICAL  
EMISSIONS:  
UL.COM/GG  
UL 2818

## Malmö 390



**SAFETY, STRENGTH and DURABILITY TESTS**  
 Prove di sicurezza, resistenza e durata  
 EN 1728:2012+AC2013  
 EN 16139:2013 level 2

SEAT Sedile	BACK Schienale	FRAME Telaio
BL2	BL2	BL2
AZ1	AZ1	AZ1
VE2	VE2	VE2
VE1	VE1	VE1
RB	RB	RB
RA	RA	RA
MO	MO	MO
MC	MC	MC

ASH  
Frassino

**€ 268,00**  
 Lacquered with visible grains  
 Laccato a poro aperto

FINISHES / Finiture



PACKING / Imballo



TECHNICAL DETAILS / Dettagli tecnici



## Malmö 392



**SAFETY, STRENGTH and DURABILITY TESTS**  
 Prove di sicurezza, resistenza e durata  
 EN 1728:2000

SEAT Sedile	BACK Schienale	FRAME Telaio
F01+FO9	F01+FO9	FR-N1-GC- BI-AN TC

ASH  
Frassino

**€ 350,00**

ASH STAINED ON SAMPLE  
Frassino tinto campione

**€ 372,00**

Matching stitches  
Cuciture in tinta

For fabrics see page 367  
Per i tessuti si veda a p. 367

FINISHES / Finiture

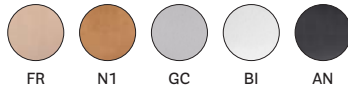

PACKING / Imballo



TECHNICAL DETAILS / Dettagli tecnici



Minimum order q.ty: 20 pcs  
Ordine minimo: 20pz



## Malmö 391



**SAFETY, STRENGTH and DURABILITY TESTS**  
 Prove di sicurezza, resistenza e durata  
 EN 1728:2000

SEAT Sedile	BACK Schienale	FRAME Telaio
C*	C*	
D40+D44	D40+D44	
D120+D123	D120+D123	
G	G	FR-N1-GC- BI-AN
H	H	TC
P	P	
TC**	TC**	
CL**	CL**	

ASH  
Frassino

**€ 338,00**  
**€ 361,00**  
**€ 399,00**  
**€ 342,00**  
**€ 466,00**  
**€ 319,00**  
**€ 325,00**

ASH STAINED ON SAMPLE  
Frassino tinto campione

**€ 360,00**  
**€ 383,00**  
**€ 421,00**  
**€ 364,00**  
**€ 488,00**  
**€ 341,00**  
**€ 347,00**

\*\*TC/CL = Minimum order 10 pcs each fabric colour  
TC/CL = Ordine minimo 10 pz per colore/tessuto

\*Excluding / Escluso C36+C39

FINISHES / Finiture



For fabrics see page 367  
Per i tessuti si veda a p. 367

PACKING / Imballo



TECHNICAL DETAILS / Dettagli tecnici



**FABRIC REQUIRED / Fabbisogno tessuto**  
 1 pc: Lin Mtrs 0,80 (h 1,40)





# Malmö 395



SEAT Sedile	BACK Schienale	FRAME Telaio	ASH Frassino	ASH STAINED ON SAMPLE Frassino tinto campione
FR-N1-GC- BI-AN	FR-N1-GC- BI-AN	FR-N1-GC- BI-AN	<b>€ 295,00</b>	<b>€ 318,00</b>
TC	TC	TC		

FINISHES / Finiture



PACKING / Imballo



TECHNICAL DETAILS / Dettagli tecnici



SAFETY, STRENGTH and DURABILITY TESTS  
Prove di sicurezza, resistenza e durata  
EN 1728:2000



# Malmö 395



SEAT Sedile	BACK Schienale	FRAME Telaio	ASH Frassino
BL2 AZ1 VE2 VE1 RB RA MO MC	BL2 AZ1 VE2 VE1 RB RA MO MC	BL2 AZ1 VE2 VE1 RB RA MO MC	<b>€ 307,00</b> Lacquered with visible grains Laccato a poro aperto

FINISHES / Finiture



PACKING / Imballo



TECHNICAL DETAILS / Dettagli tecnici



SAFETY, STRENGTH and DURABILITY TESTS  
Prove di sicurezza, resistenza e durata  
EN 1728:2000



# Malmö 397



SEAT Sedile	BACK Schienale	FRAME Telaio	ASH Frassino	ASH STAINED ON SAMPLE Frassino tinto campione
F01 + F09	F01 + F09	FR-N1-GC- BI-AN TC	<b>€ 426,00</b>	<b>€ 449,00</b>

Matching stitches  
Cuciture in tinta  
For fabrics see page 367  
Per i tessuti si veda a p. 367

FINISHES / Finiture



PACKING / Imballo



TECHNICAL DETAILS / Dettagli tecnici



SAFETY, STRENGTH and DURABILITY TESTS  
Prove di sicurezza, resistenza e durata  
EN 1728:2000



## Malmö 396



SEAT Sedile	BACK Schienale	FRAME Telaio	ASH Frassino	ASH STAINED ON SAMPLE Frassino tinto campione
C*	C*		<b>€ 412,00</b>	<b>€ 435,00</b>
D40+D44 D120+D123	D40+D44 D120+D123		<b>€ 438,00</b>	<b>€ 461,00</b>
G	G	FR-N1-GC- BI-AN	<b>€ 478,00</b>	<b>€ 502,00</b>
H	H		<b>€ 417,00</b>	<b>€ 440,00</b>
P	P	TC	<b>€ 550,00</b>	<b>€ 573,00</b>
TC**	TC**		<b>€ 393,00</b>	<b>€ 416,00</b>
CL**	CL**		<b>€ 399,00</b>	<b>€ 422,00</b>

\*\*TC/CL = Minimum order 10 pcs each fabric colour  
TC/CL = Ordine minimo 10 pz per colore/tessuto

\*Excluding / Escluso C36+C39

FINISHES / Finiture

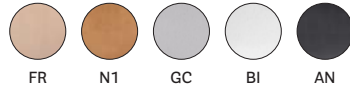

For fabrics see page 367  
Per i tessuti si veda a p. 367

PACKING / Imballo



FABRIC REQUIRED / Fabbisogno tessuto  
1pc: Lin Mtrs 0,80 (h 1,40)

TECHNICAL DETAILS / Dettagli tecnici

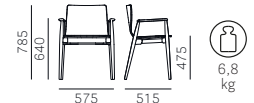

SAFETY, STRENGTH and DURABILITY TESTS  
Prove di sicurezza, resistenza e durata  
EN 1728:2000



## Malmö 232



SEAT Sedile	BACK Schienale	FRAME Telaio	ASH Frassino		ASH STAINED ON SAMPLE Frassino tinto campione	
			BRUSHED S/STEEL Inox satinato	ANTIQUE BRONZE Bronzo anticato	BRUSHED S/STEEL Inox satinato	ANTIQUE BRONZE Bronzo anticato
FR-N1-GC- BI-AN	FR-N1-GC- BI-AN	H650	<b>€ 325,00</b>	<b>€ 374,00</b>		
TC	TC				<b>€ 347,00</b>	<b>€ 396,00</b>

FINISHES / Finiture



PACKING / Imballo



TECHNICAL DETAILS / Dettagli tecnici



## Malmö 232



SEAT Sedile	BACK Schienale	FRAME Telaio	ASH Frassino	
			BRUSHED S/STEEL Inox satinato	ANTIQUE BRONZE Bronzo anticato
BL2 AZ1 VE2 VE1 RB RA MO MC	BL2 AZ1 VE2 VE1 RB RA MO MC	H650	<b>€ 336,00</b>	<b>€ 385,00</b>

Lacquered with visible grains  
Laccato a poro aperto

FINISHES / Finiture



PACKING / Imballo



TECHNICAL DETAILS / Dettagli tecnici



PRODUCT CERTIFIED  
FOR LOW CHEMICAL  
EMISSIONS:  
UL.COM/GG  
UL 2818



PRODUCT CERTIFIED  
FOR LOW CHEMICAL  
EMISSIONS:  
UL.COM/GG  
UL 2818

## Malmö 236



SEAT Sedile	BACK Schienale	FRAME Telaio	ASH Frassino		ASH STAINED ON SAMPLE Frassino tinto campione	
			BRUSHED S/STEEL Inox satinato	ANTIQUÉ BRONZE Bronzo anticato	BRUSHED S/STEEL Inox satinato	ANTIQUÉ BRONZE Bronzo anticato
FR-N1-GC- BI-AN	FR-N1-GC- BI-AN	H750	€ 336,00	€ 385,00	€ 358,00	€ 407,00
TC	TC					

FINISHES / Finiture



PACKING / Imballo



TECHNICAL DETAILS / Dettagli tecnici



## Malmö 236



SEAT Sedile	BACK Schienale	FRAME Telaio	ASH Frassino	
			BRUSHED S/STEEL Inox satinato	ANTIQUÉ BRONZE Bronzo anticato
BL2 AZ1 VE2 VE1 RB RA MO MC	BL2 AZ1 VE2 VE1 RB RA MO MC	H750	€ 347,00	€ 396,00

Lacquered with visible grains  
Laccato a poro aperto

FINISHES / Finiture



PACKING / Imballo



TECHNICAL DETAILS / Dettagli tecnici



## Malmö 252



SEAT Sedile	BACK Schienale	FRAME Telaio	ASH Frassino		ASH STAINED ON SAMPLE Frassino tinto campione	
			BRUSHED S/STEEL Inox satinato	ANTIQUÉ BRONZE Bronzo anticato	BRUSHED S/STEEL Inox satinato	ANTIQUÉ BRONZE Bronzo anticato
F01 + F09	F01 + F09	H655	€ 458,00	€ 508,00	€ 480,00	€ 530,00

Matching stitches  
Cuciture in tinta

FINISHES / Finiture



For fabrics see page 367  
Per i tessuti si veda a p. 367

PACKING / Imballo



TECHNICAL DETAILS / Dettagli tecnici



## Malmö 256



SEAT Sedile	BACK Schienale	FRAME Telaio	ASH Frassino		ASH STAINED ON SAMPLE Frassino tinto campione	
			BRUSHED S/STEEL Inox satinato	ANTIQUÉ BRONZE Bronzo anticato	BRUSHED S/STEEL Inox satinato	ANTIQUÉ BRONZE Bronzo anticato
F01+F09	F01+F09	H755	€ 469,00	€ 519,00	€ 491,00	€ 541,00

Matching stitches  
Cuciture in tinta

FINISHES / Finiture



For fabrics see page 367  
Per i tessuti si veda a p. 367

PACKING / Imballo



TECHNICAL DETAILS / Dettagli tecnici



## Malmö 242



SEAT Sedile	BACK Schienale	FRAME Telaio	ASH Frassino		ASH STAINED ON SAMPLE Frassino tinto campione	
			BRUSHED S/STEEL Inox satinato	ANTIQUÉ BRONZE Bronzo anticato	BRUSHED S/STEEL Inox satinato	ANTIQUÉ BRONZE Bronzo anticato
C*	C*	H655	€ 445,00	€ 495,00	€ 467,00	€ 517,00
D40÷D44	D40÷D44		€ 469,00	€ 519,00	€ 491,00	€ 541,00
D120÷D123	D120÷D123		€ 507,00	€ 557,00	€ 529,00	€ 579,00
G	G		€ 450,00	€ 499,00	€ 472,00	€ 521,00
H	H		€ 574,00	€ 624,00	€ 596,00	€ 646,00
P	P		€ 427,00	€ 477,00	€ 449,00	€ 499,00
TC**	TC**		€ 433,00	€ 482,00	€ 455,00	€ 504,00
CL**	CL**					

\*\*TC/CL = Minimum order 10 pcs each fabric colour  
TC/CL = Ordine minimo 10 pz per colore/tessuto

\*Excluding / Escluso C36+C39

FINISHES / Finiture



For fabrics see page 367  
Per i tessuti si veda a p. 367

PACKING / Imballo



FABRIC REQUIRED / Fabbisogno tessuto  
1pc: Lin Mtrs 0,70 (h 1,40)

TECHNICAL DETAILS / Dettagli tecnici



## Malmö 246



SEAT Sedile	BACK Schienale	FRAME Telaio	ASH Frassino		ASH STAINED ON SAMPLE Frassino tinto campione	
			BRUSHED S/STEEL Inox satinato	ANTIQUÉ BRONZE Bronzo anticato	BRUSHED S/STEEL Inox satinato	ANTIQUÉ BRONZE Bronzo anticato
C*	C*	H755	€ 456,00	€ 506,00	€ 478,00	€ 528,00
D40÷D44	D40÷D44		€ 480,00	€ 530,00	€ 502,00	€ 552,00
D120÷D123	D120÷D123		€ 518,00	€ 568,00	€ 540,00	€ 590,00
G	G		€ 461,00	€ 510,00	€ 483,00	€ 532,00
H	H		€ 585,00	€ 635,00	€ 607,00	€ 657,00
P	P		€ 438,00	€ 488,00	€ 460,00	€ 510,00
TC**	TC**		€ 444,00	€ 493,00	€ 466,00	€ 515,00
CL**	CL**					

\*\*TC/CL = Minimum order 10 pcs each fabric colour  
TC/CL = Ordine minimo 10 pz per colore/tessuto

\*Excluding / Escluso C36+C39

FINISHES / Finiture

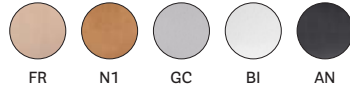

For fabrics see page 367  
Per i tessuti si veda a p. 367

PACKING / Imballo



FABRIC REQUIRED / Fabbisogno tessuto  
1pc: Lin Mtrs 0,70 (h 1,40)

TECHNICAL DETAILS / Dettagli tecnici



# Malmö



**FABRIC**  
Tessuto

Cross stitches: surcharge **€ 33,00**  
Cuciture a croce: supplemento **€ 33,00**

Simil leather, fabric (cat. G) and real leather (excluding PBS+PVE)  
Finta pelle, tessuto (cat. G) e vera pelle (escluso PBS+PVE)

For fabrics see page 367  
Per i tessuti si veda a p. 367

# Malmö 295

LOUNGE



SEAT Sedile	BACK Schienale	FRAME Telaio	ASH Frassino	ASH STAINED ON SAMPLE Frassino tinto campione
FR-N1-GC-BI-AN	FR-N1-GC-BI-AN	FR-N1-GC-BI-AN	<b>€ 340,00</b>	
TC	TC	TC		<b>€ 362,00</b>

FINISHES / Finiture

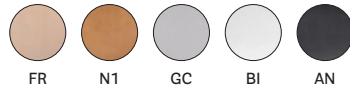

PACKING / Imballo



TECHNICAL DETAILS / Dettagli tecnici

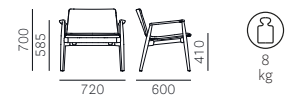

SAFETY, STRENGTH and DURABILITY TESTS  
Prove di sicurezza, resistenza e durata  
EN 1728:2012+AC2013  
EN 16139:2013 level 2

# Malmö 295

LOUNGE



SEAT Sedile	BACK Schienale	FRAME Telaio	ASH Frassino
BL2 AZ1 VE2 VE1 RB RA MO MC	BL2 AZ1 VE2 VE1 RB RA MO MC	BL2 AZ1 VE2 VE1 RB RA MO MC	<b>€ 351,00</b> Lacquered with visible grains Laccato a poro aperto

FINISHES / Finiture



PACKING / Imballo



TECHNICAL DETAILS / Dettagli tecnici

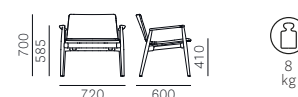

SAFETY, STRENGTH and DURABILITY TESTS  
Prove di sicurezza, resistenza e durata  
EN 1728:2012+AC2013  
EN 16139:2013 level 2



# Malmö 297

LOUNGE



SEAT Sedile	BACK Schienale	FRAME Telaio	ASH Frassino	ASH STAINED ON SAMPLE Frassino tinto campione
F01+F09	F01+F09	FR-N1-GC- BI-AN  TC	<b>€ 495,00</b>	<b>€ 517,00</b>

Matching stitches  
Cuciture in tinta

For fabrics see page 367  
Per i tessuti si veda a p. 367

FINISHES / Finiture



PACKING / Imballo



TECHNICAL DETAILS / Dettagli tecnici



SAFETY, STRENGTH and DURABILITY TESTS  
Prove di sicurezza, resistenza e durata  
EN 1728:2012+AC2013  
EN 16139:2013 level 2



# Malmö 296

LOUNGE



SEAT Sedile	BACK Schienale	FRAME Telaio	ASH Frassino	ASH STAINED ON SAMPLE Frassino tinto campione
C*	C*	FR-N1-GC- BI-AN  TC	<b>€ 500,00</b>	<b>€ 522,00</b>
D40+D44 D120+D123	D40+D44 D120+D123		<b>€ 530,00</b>	<b>€ 552,00</b>
G	G		<b>€ 579,00</b>	<b>€ 601,00</b>
H	H		<b>€ 511,00</b>	<b>€ 533,00</b>
P	P		<b>€ 602,00</b>	<b>€ 624,00</b>
TC**	TC**		<b>€ 477,00</b>	<b>€ 499,00</b>
CL**	CL**	<b>€ 482,00</b>	<b>€ 504,00</b>	

\*\*TC/CL = Minimum order 10 pcs each fabric colour  
TC/CL = Ordine minimo 10 pz per colore/tessuto

\*Excluding / Escluso C36+C39

FINISHES / Finiture

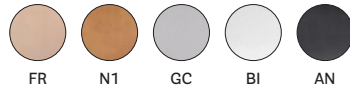

For fabrics see page 367  
Per i tessuti si veda a p. 367

PACKING / Imballo



TECHNICAL DETAILS / Dettagli tecnici



SAFETY, STRENGTH and DURABILITY TESTS  
Prove di sicurezza, resistenza e durata  
EN 1728:2012+AC2013  
EN 16139:2013 level 2

FABRIC REQUIRED / Fabbisogno tessuto  
1pc: Lin Mtrs 0,85 (h 1,40)



# Malmö 299

RELAX



SEAT Sedile	BACK Schienale	FRAME Telaio	ASH Frassino	ASH STAINED ON SAMPLE Frassino tinto campione
FR-N1-GC- BI-AN	FR-N1-GC- BI-AN	FR-N1-GC- BI-AN	<b>€ 390,00</b>	<b>€ 412,00</b>
TC	TC	TC		

FINISHES / Finiture



PACKING / Imballo



TECHNICAL DETAILS / Dettagli tecnici



PRODUCT CERTIFIED  
FOR LOW CHEMICAL  
EMISSIONS:  
UL.COM/GG  
UL 2818

## Malmö 299

RELAX



SEAT Sedile	BACK Schienale	FRAME Telaio	ASH Frassino
BL2	BL2	BL2	<p><b>€ 401,00</b> Lacquered with visible grains Laccato a poro aperto</p>
AZ1	AZ1	AZ1	
VE2	VE2	VE2	
VE1	VE1	VE1	
RB	RB	RB	
RA	RA	RA	
MO	MO	MO	
MC	MC	MC	

### FINISHES / Finiture



### PACKING / Imballo



### TECHNICAL DETAILS / Dettagli tecnici

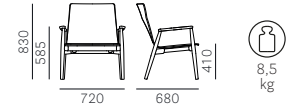

## Malmö 298

RELAX



SEAT Sedile	BACK Schienale	FRAME Telaio	ASH Frassino	ASH STAINED ON SAMPLE Frassino tinto campione
C*	C*		<b>€ 604,00</b>	<b>€ 626,00</b>
D40+D44 D120+D123	D40+D44 D120+D123		<b>€ 652,00</b>	<b>€ 674,00</b>
G	G	FR-N1-GC- BI-AN	<b>€ 724,00</b>	<b>€ 746,00</b>
H	H		<b>€ 621,00</b>	<b>€ 643,00</b>
P	P	TC	<b>€ 822,00</b>	<b>€ 844,00</b>
TC**	TC**		<b>€ 566,00</b>	<b>€ 588,00</b>
CL**	CL**		<b>€ 577,00</b>	<b>€ 599,00</b>

\*\*TC/CL = Minimum order 10 pcs each fabric colour  
TC/CL = Ordine minimo 10 pz per colore/tessuto

\*Excluding / Escluso C36+C39

### FINISHES / Finiture



For fabrics see page 367  
Per i tessuti si veda a p. 367

### PACKING / Imballo



**FABRIC REQUIRED / Fabbisogno tessuto**  
1pc: Lin Mtrs 0,95 (h 1,40)

### TECHNICAL DETAILS / Dettagli tecnici

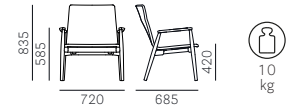

## Modus

Linear  
Lineare

MDL\_110 \*\*

MDWL\_110 \*\*



MDL\_110

MDL\_110\_L100

MDWL\_110

MDWL\_110\_L100

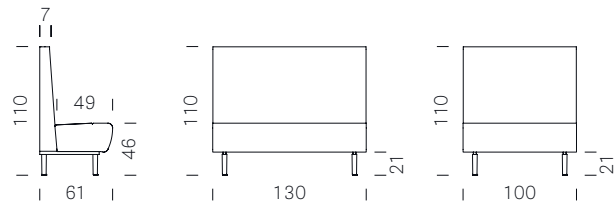
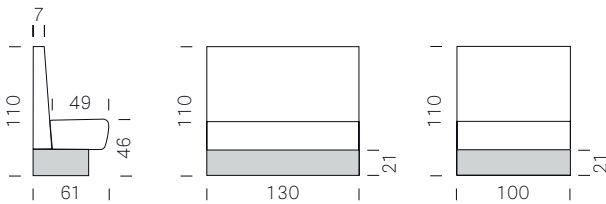

### ART. MD4

Baseboard finishes available / Zoccolo disponibile nei colori



Ash wood legs / Gambe in frassino



FABRIC Tessuto	SMOOTH Liscio	BUTTONS Bottoni	CAPITONÉ Capitoné	HORIZONTAL STITCHES Cuciture orizzontali	VERTICAL STITCHES Cuciture verticali
A	€ 965,00	€ 1.000,00	€ 1.163,00	€ 1.030,00	-
C *	€ 1.066,00	€ 1.101,00	€ 1.264,00	€ 1.131,00	€ 1.176,00
D40÷D44	€ 1.138,00	€ 1.173,00	€ 1.336,00	€ 1.203,00	€ 1.248,00
E	€ 1.287,00	€ 1.322,00	€ 1.485,00	€ 1.352,00	€ 1.397,00
G	€ 1.287,00	€ 1.322,00	€ 1.485,00	€ 1.352,00	€ 1.397,00
H *	€ 1.102,00	€ 1.137,00	€ 1.300,00	€ 1.167,00	€ 1.212,00
N	€ 1.365,00	€ 1.400,00	€ 1.563,00	€ 1.430,00	€ 1.475,00
TC	€ 965,00	€ 1.000,00	€ 1.163,00	€ 1.030,00	€ 1.075,00
PG	€ 921,00	-	-	-	-

\*Excluding / Escluso C36÷C39, C83÷C89; C100÷C101, C110÷C122, H140÷H143

Surcharge COUPLE SIDEBORD L = 44 cm (item MD4/LAT\_50) = € 90,00

Supplemento COPPIA ZOCCOLO LATERALE L = 44 cm (cod. MD4/LAT\_50) = € 90,00

\*\*KIT/MD2\_FIX\_MURO = € 20,00

Mandatory in case of a single bench resting on the wall. Recommended in case of side-by-side benches resting on the wall.  
Obbligatorio in caso di panca singola che poggia a parete. Consigliato in caso di panche affiancate che poggiano a parete.

The benches are suitable for wall mounting, if not we recommend to order the backside panel, see at page 211  
Le panche sono adatte per utilizzo a parete. Diversamente consigliamo l'acquisto del pannello posteriore, si veda da pag. 211

For fabrics see page 367  
Per i tessuti si veda a p. 367

Dimensions of Modus units are expressed in centimeters  
Le misure dei moduli Modus sono espresse in centimetri



## Modus

Linear  
Lineare

MDL\_140 \*\*



MDWL\_140 \*\*

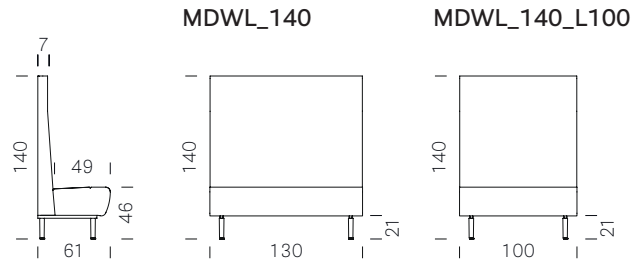
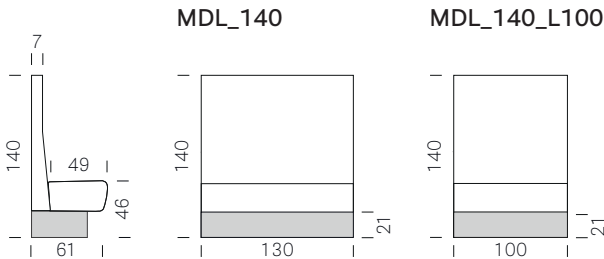

### ART. MD4

Baseboard finishes available / Zoccolo disponibile nei colori



Ash wood legs / Gambe in frassino



FABRIC Tessuto	SMOOTH Liscio	BUTTONS Bottoni	CAPITONÉ Capitoné	HORIZONTAL STITCHES Cuciture orizzontali	VERTICAL STITCHES Cuciture verticali
A	€ 1.108,00	€ 1.173,00	€ 1.460,00	€ 1.233,00	-
C *	€ 1.232,00	€ 1.297,00	€ 1.584,00	€ 1.357,00	€ 1.357,00
D40÷D44	€ 1.326,00	€ 1.391,00	€ 1.678,00	€ 1.451,00	€ 1.451,00
E	€ 1.446,00	€ 1.511,00	€ 1.798,00	€ 1.571,00	€ 1.571,00
G	€ 1.446,00	€ 1.511,00	€ 1.798,00	€ 1.571,00	€ 1.571,00
H *	€ 1.278,00	€ 1.343,00	€ 1.630,00	€ 1.403,00	€ 1.403,00
N	€ 1.542,00	€ 1.607,00	€ 1.894,00	€ 1.667,00	€ 1.667,00
TC	€ 1.108,00	€ 1.173,00	€ 1.460,00	€ 1.233,00	€ 1.233,00
PG	€ 1.045,00	-	-	-	-

\*Excluding / Escluso C36÷C39, C83÷C89; C100÷C101, C110÷C122, H140÷H143

Surcharge COUPLE SIDEBORD L = 44 cm (item MD4/LAT\_50) = € 90,00

Supplemento COPPIA ZOCCOLO LATERALE L = 44 cm (cod. MD4/LAT\_50) = € 90,00

\*\*KIT/MD2\_FIX\_MURO = € 20,00

Mandatory in case of a single bench resting on the wall. Recommended in case of side-by-side benches resting on the wall.  
Obbligatorio in caso di panca singola che poggia a parete. Consigliato in caso di panche affiancate che poggiano a parete.

The benches are suitable for wall mounting, if not we recommend to order the backside panel, see at page 211  
Le panche sono adatte per utilizzo a parete. Diversamente consigliamo l'acquisto del pannello posteriore, si veda da pag. 211

For fabrics see page 367  
Per i tessuti si veda a p. 367

Dimensions of Modus units are expressed in centimeters  
Le misure dei moduli Modus sono espresse in centimetri

## Modus

Linear  
Lineare

### MDL\_175 \*\*

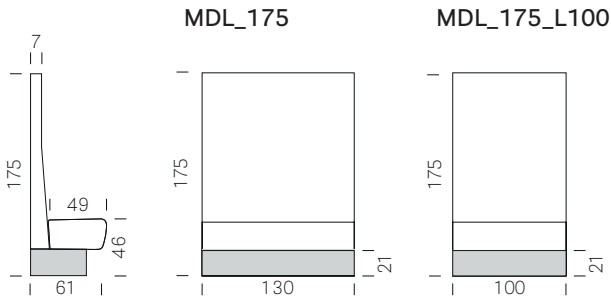
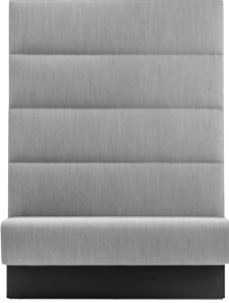

### MDL\_240

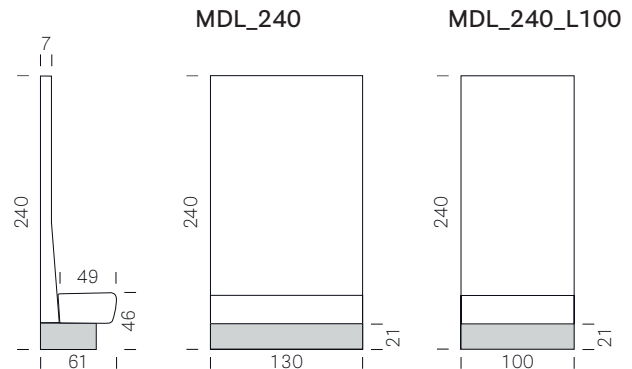

#### ART. MD4

Baseboard finishes available / Zoccolo disponibile nei colori

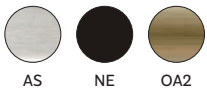

FABRIC Tessuto	SMOOTH Liscio	BUTTONS Bottoni	CAPITONÉ Capitoné	HORIZONTAL STITCHES Cuciture orizzontali
A	€ 1.108,00	€ 1.173,00	€ 1.460,00	€ 1.233,00
C *	€ 1.232,00	€ 1.297,00	€ 1.584,00	€ 1.357,00
D40+D44	€ 1.326,00	€ 1.391,00	€ 1.678,00	€ 1.451,00
E	€ 1.446,00	€ 1.511,00	€ 1.798,00	€ 1.571,00
G	€ 1.446,00	€ 1.511,00	€ 1.798,00	€ 1.571,00
H *	€ 1.278,00	€ 1.343,00	€ 1.630,00	€ 1.403,00
N	€ 1.542,00	€ 1.607,00	€ 1.894,00	€ 1.667,00
TC	€ 1.108,00	€ 1.173,00	€ 1.460,00	€ 1.233,00
PG	€ 1.045,00	-	-	-

\*Excluding / Escluso C36+C39, C83+C89; C100+C101, C110+C122, H140+H143

Surcharge COUPLE SIDEBORD L = 44 cm (item MD4/LAT\_50) = € 90,00  
Supplemento COPPIA ZOCCOLO LATERALE L = 44 cm (cod. MD4/LAT\_50) = € 90,00

\*\*KIT/MD2\_FIX\_MURO = € 20,00

Mandatory in case of a single bench resting on the wall. Recommended in case of side-by-side benches resting on the wall.  
Obbligatorio in caso di panca singola che poggia a parete. Consigliato in caso di panche affiancate che poggiano a parete.

The benches are suitable for wall mounting, if not we recommend to order the backside panel, see at page 211  
Le panche sono adatte per utilizzo a parete. Diversamente consigliamo l'acquisto del pannello posteriore, si veda da pag. 211

For fabrics see page 367  
Per i tessuti si veda a p. 367

Dimensions of Modus units are expressed in centimeters  
Le misure dei moduli Modus sono espresse in centimetri

Non-self-supporting module, wall fixing required. KIT/MD2\_FIX\_MURO included.  
Modulo non autoportante, fissaggio a muro obbligatorio. KIT/MD2\_FIX\_MURO incluso.

FABRIC Tessuto	SMOOTH Liscio	BUTTONS Bottoni	HORIZONTAL STITCHES Cuciture orizzontali
A	€ 1.333,00	€ 1.410,00	€ 1.493,00
C *	€ 1.481,00	€ 1.558,00	€ 1.641,00
D40+D44	€ 1.612,00	€ 1.689,00	€ 1.772,00
E	€ 1.784,00	€ 1.861,00	€ 1.944,00
G	€ 1.784,00	€ 1.861,00	€ 1.944,00
H *	€ 1.557,00	€ 1.634,00	€ 1.717,00
N	€ 1.897,00	€ 1.974,00	€ 2.057,00
TC	€ 1.333,00	€ 1.410,00	€ 1.493,00
PG	€ 1.249,00	-	-

\*Excluding / Escluso C36+C39, C83+C89; C100+C101, C110+C122, H140+H143

# Modus

Back to back unit  
Bifacciale

MDB\_110



MDWB\_110



MDB\_110

MDB\_110\_L100

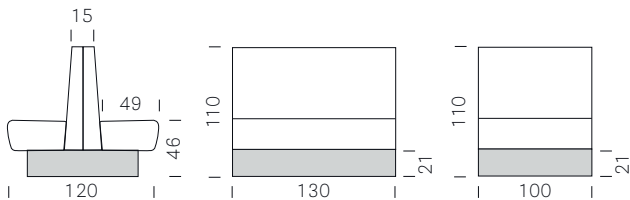

MDWB\_110

MDWB\_110\_L100

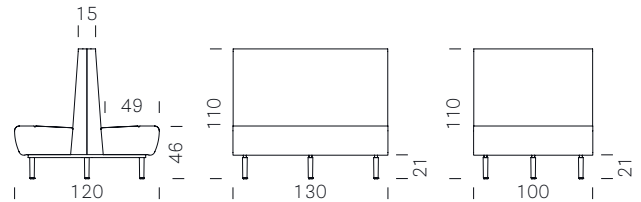

## ART. MD4

Baseboard finishes available / Zoccolo disponibile nei colori

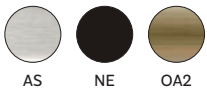

AS NE OA2

Ash wood legs / Gambe in frassino



FR N1 AN

FABRIC Tessuto	SMOOTH Liscio	BUTTONS Bottoni	CAPITONÉ Capitoné	HORIZONTAL STITCHES Cuciture orizzontali	VERTICAL STITCHES Cuciture verticali
A	€ 1.880,00	€ 1.950,00	€ 2.276,00	€ 2.010,00	-
C *	€ 2.082,00	€ 2.152,00	€ 2.478,00	€ 2.212,00	€ 2.302,00
D40÷D44	€ 2.226,00	€ 2.296,00	€ 2.622,00	€ 2.356,00	€ 2.446,00
E	€ 2.524,00	€ 2.594,00	€ 2.920,00	€ 2.654,00	€ 2.744,00
G	€ 2.524,00	€ 2.594,00	€ 2.920,00	€ 2.654,00	€ 2.744,00
H *	€ 2.154,00	€ 2.224,00	€ 2.550,00	€ 2.284,00	€ 2.374,00
N	€ 2.680,00	€ 2.750,00	€ 3.076,00	€ 2.810,00	€ 2.900,00
TC	€ 1.880,00	€ 1.950,00	€ 2.276,00	€ 2.010,00	€ 2.100,00
PG	€ 1.792,00	-	-	-	-

\*Excluding / Escluso C36÷C39, C83÷C89; C100÷C101, C110÷C122, H140÷H143

Surcharge COUPLE SIDEBBOARD L = 85,5 cm (item MD4/LAT\_100) = € 160,00  
Supplemento COPPIA ZOCCOLO LATERALE L = 85,5 cm (cod. MD4/LAT\_100) = € 160,00

For fabrics see page 367  
Per i tessuti si veda a p. 367

Dimensions of Modus units are expressed in centimeters  
Le misure dei moduli Modus sono espresse in centimetri

## Modus

Back to back unit  
Bifacciale

### MDB\_140



### MDWB\_140

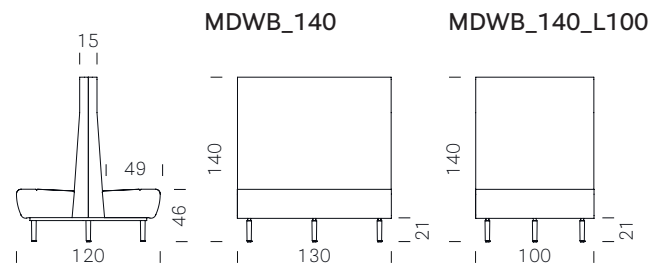
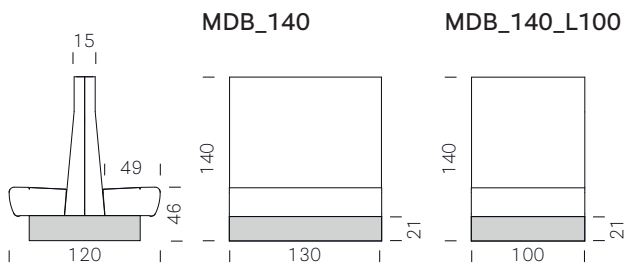

#### ART. MD4

Baseboard finishes available / Zoccolo disponibile nei colori

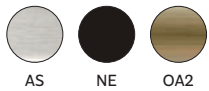

Ash wood legs / Gambe in frassino



FABRIC Tessuto	SMOOTH Liscio	BUTTONS Bottoni	CAPITONÉ Capitoné	HORIZONTAL STITCHES Cuciture orizzontali	VERTICAL STITCHES Cuciture verticali
A	€ 2.156,00	€ 2.286,00	€ 2.860,00	€ 2.406,00	-
C *	€ 2.404,00	€ 2.534,00	€ 3.108,00	€ 2.654,00	€ 2.654,00
D40÷D44	€ 2.592,00	€ 2.722,00	€ 3.296,00	€ 2.842,00	€ 2.842,00
E	€ 2.832,00	€ 2.962,00	€ 3.536,00	€ 3.082,00	€ 3.082,00
G	€ 2.832,00	€ 2.962,00	€ 3.536,00	€ 3.082,00	€ 3.082,00
H *	€ 2.496,00	€ 2.626,00	€ 3.200,00	€ 2.746,00	€ 2.746,00
N	€ 3.024,00	€ 3.154,00	€ 3.728,00	€ 3.274,00	€ 3.274,00
TC	€ 2.156,00	€ 2.286,00	€ 2.860,00	€ 2.406,00	€ 2.406,00
PG	€ 2.030,00	-	-	-	-

\*Excluding / Escluso C36÷C39, C83÷C89; C100÷C101, C110÷C122, H140÷H143

Surcharge COUPLE SIDEBORD L = 85,5 cm (item MD4/LAT\_100) = € 160,00  
Supplemento COPPIA ZOCCOLO LATERALE L = 85,5 cm (cod. MD4/LAT\_100) = € 160,00

For fabrics see page 367  
Per i tessuti si veda a p. 367

Dimensions of Modus units are expressed in centimeters  
Le misure dei moduli Modus sono espresse in centimetri

# Modus

Back to back unit  
Bifacciale

MDB\_175

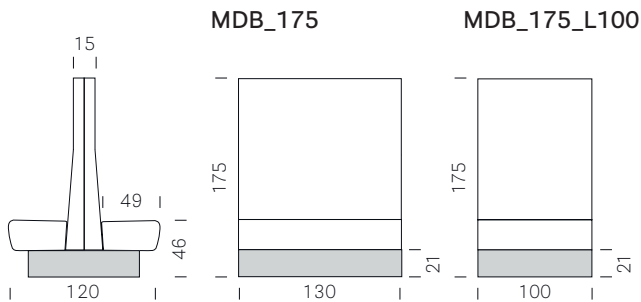

## ART. MD4

Baseboard finishes available / Zoccolo disponibile nei colori



FABRIC Tessuto	SMOOTH Liscio	BUTTONS Bottoni	CAPITONÉ Capitoné	HORIZONTAL STITCHES Cuciture orizzontali
A	€ 2.156,00	€ 2.286,00	€ 2.860,00	€ 2.406,00
C *	€ 2.404,00	€ 2.534,00	€ 3.108,00	€ 2.654,00
D40+D44	€ 2.592,00	€ 2.722,00	€ 3.296,00	€ 2.842,00
E	€ 2.832,00	€ 2.962,00	€ 3.536,00	€ 3.082,00
G	€ 2.832,00	€ 2.962,00	€ 3.536,00	€ 3.082,00
H *	€ 2.496,00	€ 2.626,00	€ 3.200,00	€ 2.746,00
N	€ 3.024,00	€ 3.154,00	€ 3.728,00	€ 3.274,00
TC	€ 2.156,00	€ 2.286,00	€ 2.860,00	€ 2.406,00
PG	€ 2.030,00	-	-	-

\*Excluding / Escluso C36+C39, C83+C89; C100+C101, C110+C122, H140+H143

Surcharge COUPLE SIDEBBOARD L = 85,5 cm (item MD4/LAT\_100) = € 160,00  
 Supplemento COPPIA ZOCCOLO LATERALE L = 85,5 cm (cod. MD4/LAT\_100) = € 160,00

For fabrics see page 367  
 Per i tessuti si veda a p. 367

Dimensions of Modus units are expressed in centimeters  
 Le misure dei moduli Modus sono espresse in centimetri

# Modus

Corner unit  
Angolare

MDA\_110



MDA\_140

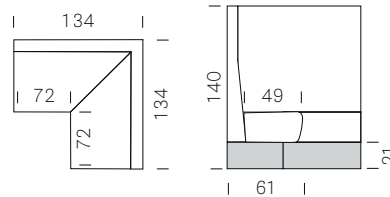
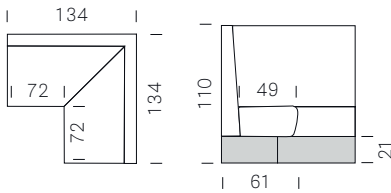

## ART. MD4

Baseboard finishes available / Zoccolo disponibile nei colori



FABRIC Tessuto	SMOOTH Liscio	BUTTONS Bottoni	CAPITONÉ Capitoné	HORIZONTAL STITCHES Cuciture orizzontali	VERTICAL STITCHES Cuciture verticali
A	€ 1.930,00	€ 2.000,00	€ 2.326,00	€ 2.060,00	-
C *	€ 2.132,00	€ 2.202,00	€ 2.528,00	€ 2.262,00	€ 2.352,00
D40+D44	€ 2.276,00	€ 2.346,00	€ 2.672,00	€ 2.406,00	€ 2.496,00
E	€ 2.574,00	€ 2.644,00	€ 2.970,00	€ 2.704,00	€ 2.794,00
G	€ 2.574,00	€ 2.644,00	€ 2.970,00	€ 2.704,00	€ 2.794,00
H *	€ 2.204,00	€ 2.274,00	€ 2.600,00	€ 2.334,00	€ 2.424,00
N	€ 2.730,00	€ 2.800,00	€ 3.126,00	€ 2.860,00	€ 2.950,00
TC	€ 1.930,00	€ 2.000,00	€ 2.326,00	€ 2.060,00	€ 2.150,00
PG	€ 1.842,00	-	-	-	-

\*Excluding / Escluso C36+C39, C83+C89; C100+C101, C110+C122, H140+H143

Surcharge COUPLE SIDEBBOARD L = 44 cm (item MD4/LAT\_50) = € 90,00  
 Supplemento COPPIA ZOCCOLO LATERALE L = 44 cm (cod. MD4/LAT\_50) = € 90,00

FABRIC Tessuto	SMOOTH Liscio	BUTTONS Bottoni	CAPITONÉ Capitoné	HORIZONTAL STITCHES Cuciture orizzontali	VERTICAL STITCHES Cuciture verticali
A	€ 2.216,00	€ 2.346,00	€ 2.920,00	€ 2.466,00	-
C *	€ 2.464,00	€ 2.594,00	€ 3.168,00	€ 2.714,00	€ 2.714,00
D40+D44	€ 2.652,00	€ 2.782,00	€ 3.356,00	€ 2.902,00	€ 2.902,00
E	€ 2.892,00	€ 3.022,00	€ 3.596,00	€ 3.142,00	€ 3.142,00
G	€ 2.892,00	€ 3.022,00	€ 3.596,00	€ 3.142,00	€ 3.142,00
H *	€ 2.556,00	€ 2.686,00	€ 3.260,00	€ 2.806,00	€ 2.806,00
N	€ 3.084,00	€ 3.214,00	€ 3.788,00	€ 3.334,00	€ 3.334,00
TC	€ 2.216,00	€ 2.346,00	€ 2.920,00	€ 2.466,00	€ 2.466,00
PG	€ 2.090,00	-	-	-	-

\*Excluding / Escluso C36+C39, C83+C89; C100+C101, C110+C122, H140+H143

The benches are suitable for wall mounting, if not we recommend to order the backside panel, see at page 211  
 Le panche sono adatte per utilizzo a parete. Diversamente consigliamo l'acquisto del pannello posteriore, si veda da pag. 211

For fabrics see page 367  
 Per i tessuti si veda a p. 367

Dimensions of Modus units are expressed in centimeters  
 Le misure dei moduli Modus sono espresse in centimetri

## Modus

Corner unit  
Angolare

### MDA\_175

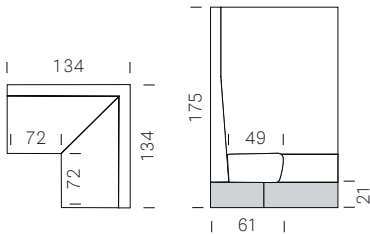

### MDA\_240

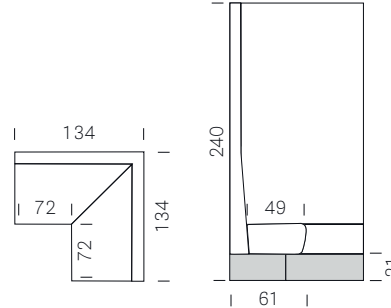

#### ART. MD4

Baseboard finishes available / Zoccolo disponibile nei colori

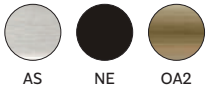

AS NE OA2

FABRIC Tessuto	SMOOTH Liscio	BUTTONS Bottoni	CAPITONÉ Capitoné	HORIZONTAL STITCHES Cuciture orizzontali
A	€ 2.216,00	€ 2.346,00	€ 2.920,00	€ 2.466,00
C *	€ 2.464,00	€ 2.594,00	€ 3.168,00	€ 2.714,00
D40+D44	€ 2.652,00	€ 2.782,00	€ 3.356,00	€ 2.902,00
E	€ 2.892,00	€ 3.022,00	€ 3.596,00	€ 3.142,00
G	€ 2.892,00	€ 3.022,00	€ 3.596,00	€ 3.142,00
H *	€ 2.556,00	€ 2.686,00	€ 3.260,00	€ 2.806,00
N	€ 3.084,00	€ 3.214,00	€ 3.788,00	€ 3.334,00
TC	€ 2.216,00	€ 2.346,00	€ 2.920,00	€ 2.466,00
PG	€ 2.090,00	-	-	-

\*Excluding / Escluso C36+C39, C83+C89; C100+C101, C110+C122, H140+H143

Surcharge COUPLE SIDEBBOARD L = 44 cm (item MD4/LAT\_50) = € 90,00  
Supplemento COPPIA ZOCCOLO LATERALE L = 44 cm (cod. MD4/LAT\_50) = € 90,00

Non-self-supporting module, wall fixing required. KIT/MD2\_FIX\_MURO included.  
Modulo non autoportante, fissaggio a muro obbligatorio. KIT/MD2\_FIX\_MURO incluso.

FABRIC Tessuto	SMOOTH Liscio	BUTTONS Bottoni	HORIZONTAL STITCHES Cuciture orizzontali
A	€ 2.666,00	€ 2.820,00	€ 2.986,00
C *	€ 2.962,00	€ 3.116,00	€ 3.282,00
D40+D44	€ 3.224,00	€ 3.378,00	€ 3.544,00
E	€ 3.568,00	€ 3.722,00	€ 3.888,00
G	€ 3.568,00	€ 3.722,00	€ 3.888,00
H *	€ 3.114,00	€ 3.268,00	€ 3.434,00
N	€ 3.794,00	€ 3.948,00	€ 4.114,00
TC	€ 2.666,00	€ 2.820,00	€ 2.986,00
PG	€ 2.498,00	-	-

\*Excluding / Escluso C36+C39, C83+C89; C100+C101, C110+C122, H140+H143

The benches are suitable for wall mounting, if not we recommend to order the backside panel, see at page 211  
Le panche sono adatte per utilizzo a parete. Diversamente consigliamo l'acquisto del pannello posteriore, si veda da pag. 211

For fabrics see page 367  
Per i tessuti si veda a p. 367

Dimensions of Modus units are expressed in centimeters  
Le misure dei moduli Modus sono espresse in centimetri

## Modus

Back to back corner unit  
Angolare bifacciale

MDAB\_110



MDAB\_140

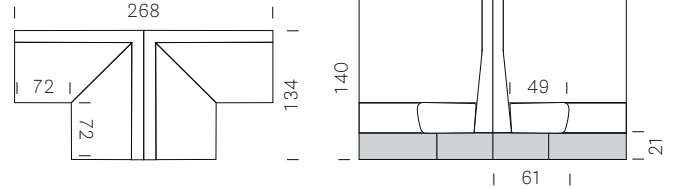
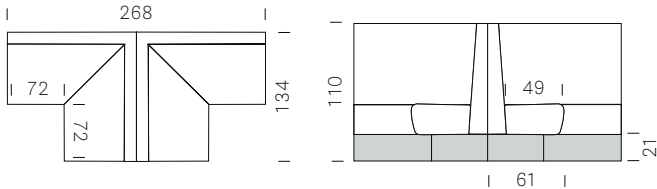

### ART. MD4

Baseboard finishes available / Zoccolo disponibile nei colori

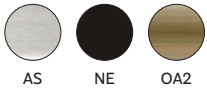

FABRIC Tessuto	SMOOTH Liscio	BUTTONS Bottoni	CAPITONÉ Capitoné	HORIZONTAL STITCHES Cuciture orizzontali	VERTICAL STITCHES Cuciture verticali
A	€ 3.860,00	€ 4.000,00	€ 4.652,00	€ 4.120,00	-
C *	€ 4.264,00	€ 4.404,00	€ 5.056,00	€ 4.524,00	€ 4.704,00
D40+D44	€ 4.552,00	€ 4.692,00	€ 5.344,00	€ 4.812,00	€ 4.992,00
E	€ 5.148,00	€ 5.288,00	€ 5.940,00	€ 5.408,00	€ 5.588,00
G	€ 5.148,00	€ 5.288,00	€ 5.940,00	€ 5.408,00	€ 5.588,00
H *	€ 4.408,00	€ 4.548,00	€ 5.200,00	€ 4.668,00	€ 4.848,00
N	€ 5.460,00	€ 5.600,00	€ 6.252,00	€ 5.720,00	€ 5.900,00
TC	€ 3.860,00	€ 4.000,00	€ 4.652,00	€ 4.120,00	€ 4.300,00
PG	€ 3.684,00	-	-	-	-

\*Excluding / Escluso C36+C39, C83+C89; C100+C101, C110+C122, H140+H143

Surcharge COUPLE SIDEBBOARD L = 85,5 cm (item MD4/LAT\_100) = € 160,00  
Supplemento COPPIA ZOCCOLO LATERALE L = 85,5 cm (cod. MD4/LAT\_100) = € 160,00

FABRIC Tessuto	SMOOTH Liscio	BUTTONS Bottoni	CAPITONÉ Capitoné	HORIZONTAL STITCHES Cuciture orizzontali	VERTICAL STITCHES Cuciture verticali
A	€ 4.432,00	€ 4.692,00	€ 5.840,00	€ 4.932,00	-
C *	€ 4.928,00	€ 5.188,00	€ 6.336,00	€ 5.428,00	€ 5.428,00
D40+D44	€ 5.304,00	€ 5.564,00	€ 6.712,00	€ 5.804,00	€ 5.804,00
E	€ 5.784,00	€ 6.044,00	€ 7.192,00	€ 6.284,00	€ 6.284,00
G	€ 5.784,00	€ 6.044,00	€ 7.192,00	€ 6.284,00	€ 6.284,00
H *	€ 5.112,00	€ 5.372,00	€ 6.520,00	€ 5.612,00	€ 5.612,00
N	€ 6.168,00	€ 6.428,00	€ 7.576,00	€ 6.668,00	€ 6.668,00
TC	€ 4.432,00	€ 4.692,00	€ 5.840,00	€ 4.932,00	€ 4.932,00
PG	€ 4.180,00	-	-	-	-

\*Excluding / Escluso C36+C39, C83+C89; C100+C101, C110+C122, H140+H143

The benches are suitable for wall mounting, if not we recommend to order the backside panel, see at page 211  
Le panche sono adatte per utilizzo a parete. Diversamente consigliamo l'acquisto del pannello posteriore, si veda da pag. 211

For fabrics see page 367  
Per i tessuti si veda a p. 367

Dimensions of Modus units are expressed in centimeters  
Le misure dei moduli Modus sono espresse in centimetri



# Modus

Back to back corner unit  
Angolare bifacciale

MDAB\_175

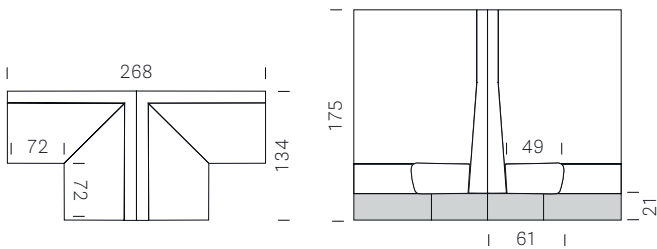

## ART. MD4

Baseboard finishes available / Zoccolo disponibile nei colori



AS NE OA2

FABRIC Tessuto	SMOOTH Liscio	BUTTONS Bottoni	CAPITONÉ Capitoné	HORIZONTAL STITCHES Cuciture orizzontali
A	€ 4.432,00	€ 4.692,00	€ 5.840,00	€ 4.932,00
C *	€ 4.928,00	€ 5.188,00	€ 6.336,00	€ 5.428,00
D40÷D44	€ 5.304,00	€ 5.564,00	€ 6.712,00	€ 5.804,00
E	€ 5.784,00	€ 6.044,00	€ 7.192,00	€ 6.284,00
G	€ 5.784,00	€ 6.044,00	€ 7.192,00	€ 6.284,00
H *	€ 5.112,00	€ 5.372,00	€ 6.520,00	€ 5.612,00
N	€ 6.168,00	€ 6.428,00	€ 7.576,00	€ 6.668,00
TC	€ 4.432,00	€ 4.692,00	€ 5.840,00	€ 4.932,00
PG	€ 4.180,00	-	-	-

\*Excluding / Escluso C36÷C39, C83÷C89; C100÷C101, C110÷C122, H140÷H143

Surcharge COUPLE SIDEBBOARD L = 85,5 cm (item MD4/LAT\_100) = € 160,00  
Supplemento COPPIA ZOCCOLO LATERALE L = 85,5 cm (cod. MD4/LAT\_100) = € 160,00

The benches are suitable for wall mounting, if not we recommend to order the backside panel, see at page 211  
Le panche sono adatte per utilizzo a parete. Diversamente consigliamo l'acquisto del pannello posteriore, si veda da pag. 211

For fabrics see page 367  
Per i tessuti si veda a p. 367

Dimensions of Modus units are expressed in centimeters  
Le misure dei moduli Modus sono espresse in centimetri

## Modus

Customized linear unit - Available for items MDL\_110, MDL\_140  
Lineare personalizzato - Disponibile per art. MDL\_110, MDL\_140

### MDP\_110 \*\*

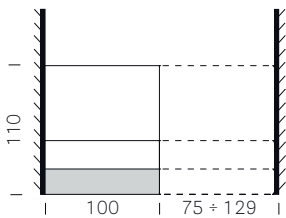
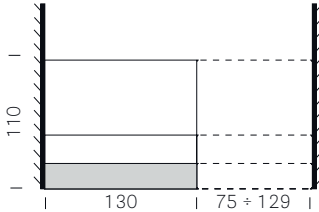

### MDP\_140 \*\*

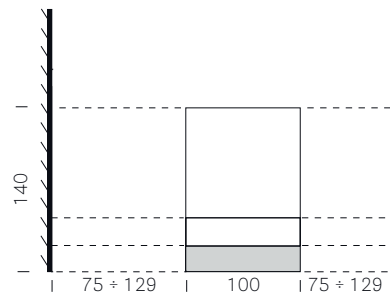
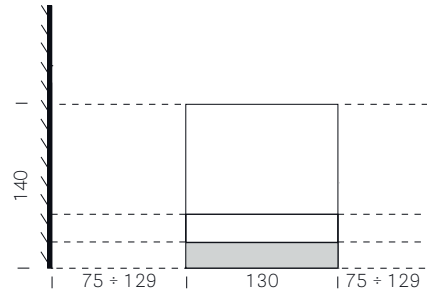

### ART. MD4

Baseboard finishes available / Zoccolo disponibile nei colori

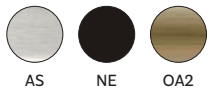

AS NE OA2

FABRIC Tessuto	SMOOTH Liscio	HORIZONTAL STITCHES Cuciture orizzontali
A	€ 1.158,00	€ 1.236,00
C *	€ 1.280,00	€ 1.358,00
D40÷D44	€ 1.366,00	€ 1.444,00
E	€ 1.545,00	€ 1.623,00
G	€ 1.545,00	€ 1.623,00
H *	€ 1.323,00	€ 1.401,00
N	€ 1.638,00	€ 1.716,00
TC	€ 1.158,00	€ 1.236,00
PG	€ 1.106,00	-

\*Excluding / Escluso C36÷C39, C83÷C89; C100÷C101, C110÷C122, H140÷H143

Surcharge COUPLE SIDEBORD L = 44 cm (item MD4/LAT\_50) = € 90,00  
Supplemento COPPIA ZOCCOLO LATERALE L = 44 cm (cod. MD4/LAT\_50) = € 90,00

\*\*KIT/MD2\_FIX\_MURO = € 20,00

Mandatory in case of a single bench resting on the wall. Recommended in case of side-by-side benches resting on the wall.  
Obbligatorio in caso di panca singola che poggia a parete. Consigliato in caso di panche affiancate che poggiano a parete.

FABRIC Tessuto	SMOOTH Liscio	HORIZONTAL STITCHES Cuciture orizzontali
A	€ 1.330,00	€ 1.480,00
C *	€ 1.479,00	€ 1.629,00
D40÷D44	€ 1.592,00	€ 1.742,00
E	€ 1.736,00	€ 1.886,00
G	€ 1.736,00	€ 1.886,00
H *	€ 1.534,00	€ 1.684,00
N	€ 1.851,00	€ 2.001,00
TC	€ 1.330,00	€ 1.480,00
PG	€ 1.254,00	-

\*Excluding / Escluso C36÷C39, C83÷C89; C100÷C101, C110÷C122, H140÷H143

For fabrics see page 367  
Per i tessuti si veda a p. 367

Dimensions of Modus units are expressed in centimeters  
Le misure dei moduli Modus sono espresse in centimetri

## Modus

Customized linear unit - Available for items MDL\_175, MDL\_240  
Lineare personalizzato - Disponibile per art. MDL\_175, MDL\_240

### MDP\_175 \*\*

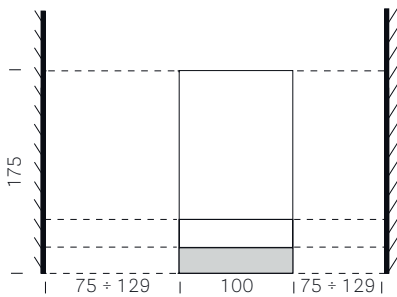
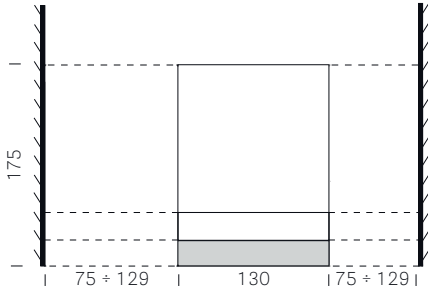

### MDP\_240

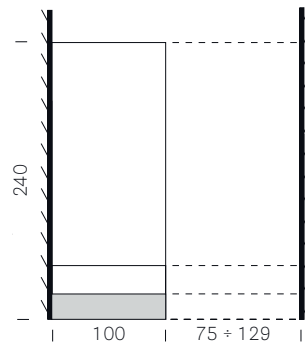
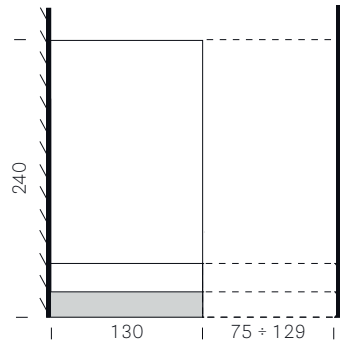

### ART. MD4

Baseboard finishes available / Zoccolo disponibile nei colori



Non-self-supporting module, wall fixing required. KIT/MD2\_FIX\_MURO included.  
Modulo non autoportante, fissaggio a muro obbligatorio. KIT/MD2\_FIX\_MURO incluso.

FABRIC Tessuto	SMOOTH Liscio	HORIZONTAL STITCHES Cuciture orizzontali
A	€ 1.330,00	€ 1.480,00
C *	€ 1.479,00	€ 1.629,00
D40÷D44	€ 1.592,00	€ 1.742,00
E	€ 1.736,00	€ 1.886,00
G	€ 1.736,00	€ 1.886,00
H *	€ 1.534,00	€ 1.684,00
N	€ 1.851,00	€ 2.001,00
TC	€ 1.330,00	€ 1.480,00
PG	€ 1.254,00	-

\*Excluding / Escluso C36÷C39, C83÷C89; C100÷C101, C110÷C122, H140÷H143

Surcharge COUPLE SIDEBBOARD L = 44 cm (item MD4/LAT\_50) = € 90,00  
Supplemento COPPIA ZOCCOLO LATERALE L = 44 cm (cod. MD4/LAT\_50) = € 90,00

\*\*KIT/MD2\_FIX\_MURO = € 20,00

Mandatory in case of a single bench resting on the wall. Recommended in case of side-by-side benches resting on the wall.  
Obbligatorio in caso di panca singola che poggia a parete. Consigliato in caso di panche affiancate che poggiano a parete.

FABRIC Tessuto	SMOOTH Liscio	HORIZONTAL STITCHES Cuciture orizzontali
A	€ 1.600,00	€ 1.792,00
C *	€ 1.778,00	€ 1.970,00
D40÷D44	€ 1.935,00	€ 2.127,00
E	€ 2.141,00	€ 2.333,00
G	€ 2.141,00	€ 2.333,00
H *	€ 1.869,00	€ 2.061,00
N	€ 2.277,00	€ 2.469,00
TC	€ 1.600,00	€ 1.792,00
PG	€ 1.499,00	-

\*Excluding / Escluso C36÷C39, C83÷C89; C100÷C101, C110÷C122, H140÷H143

For fabrics see page 367  
Per i tessuti si veda a p. 367

Dimensions of Modus units are expressed in centimeters  
Le misure dei moduli Modus sono espresse in centimetri

## Modus

Backside laminate panel - Available for items MDL\_110, MDL\_140, MDL\_175  
 Pannello posteriore in laminato - Disponibile per art. MDL\_110, MDL\_140, MDL\_175

For Modus linear 130 cm  
 Per Modus lineare 130 cm

### MD5\_110x130

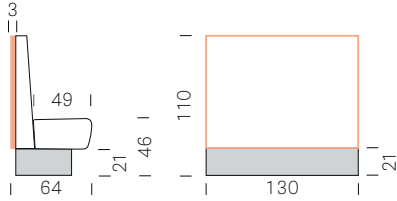

For Modus linear 100 cm  
 Per Modus lineare 100 cm

### MD5\_110x100

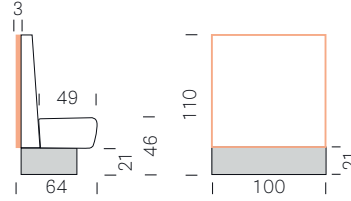

### MD5\_140x130

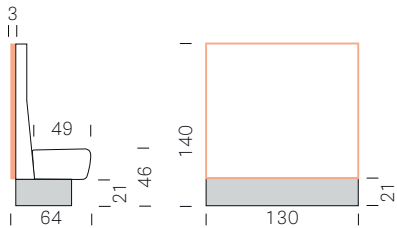

### MD5\_140x100

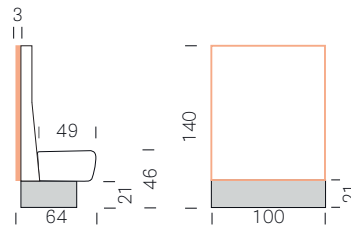

### MD5\_175x130

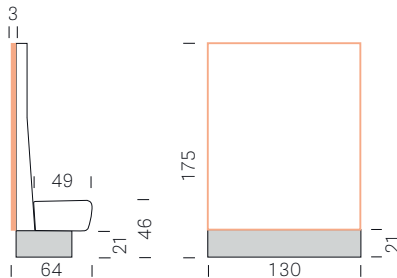

### MD5\_175x100

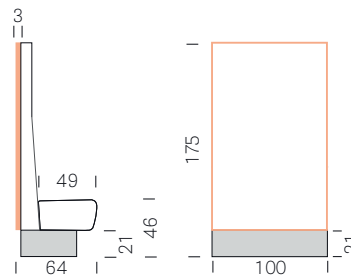

PANEL Pannello	HEIGHT Altezza	WIDTH Larghezza	PRICE * Prezzo
MD5_110x130	110	130	€ 319,00
MD5_140x130	140	130	€ 470,00
MD5_175x130	175	130	€ 470,00

PANEL Pannello	HEIGHT Altezza	WIDTH Larghezza	PRICE * Prezzo
MD5_110x100	110	100	€ 319,00
MD5_140x100	140	100	€ 470,00
MD5_175x100	175	100	€ 470,00

\* Packing and back kickboard included  
 Imballo e zoccolo posteriore inclusi

### ART. MD5

Laminate back side panel with ABS edge, thickness 30 mm, colours available  
 Pannello in laminato con bordo ABS, spessore 30 mm, disponibile nei colori

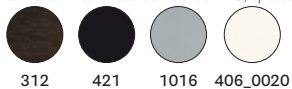

Dimensions of Modus units are expressed in centimeters  
 Le misure dei moduli Modus sono espresse in centimetri

## Modus

Backside laminate panel - Available for items MDA\_110, MDA\_140, MDA\_175  
 Pannello posteriore in laminato - Disponibile per art. MDA\_110, MDA\_140, MDA\_175

For Modus corner unit  
 Per Modus angolare

### MD5\_110x134

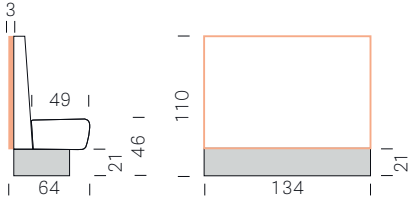

### MD5\_140x134

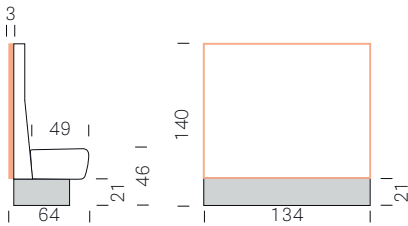

### MD5\_175x134

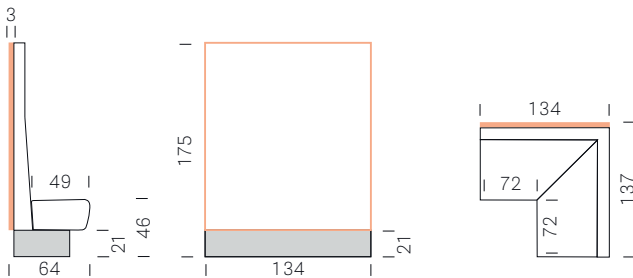

PANEL Pannello	HEIGHT Altezza	WIDTH Larghezza	PRICE * Prezzo
MD5_110x134	110	134	€ 319,00
MD5_140x134	140	134	€ 470,00
MD5_175x134	175	134	€ 470,00

\* Packing and back kickboard included  
 Imballo e zoccolo posteriore inclusi

### ART. MD5

Laminate back side panel with ABS edge, thickness 30 mm, colours available  
 Pannello in laminato con bordo ABS, spessore 30 mm, disponibile nei colori

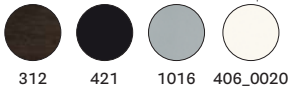

Dimensions of Modus units are expressed in centimeters  
 Le misure dei moduli Modus sono espresse in centimetri

## Modus

Backside upholstered panel - Available for items MDL\_175, MDA\_175  
Pannello posteriore imbottito - Disponibile per art. MDL\_175, MDA\_175

For Modus linear 130 cm  
Per Modus lineare 130 cm

**MD5\_175x130**

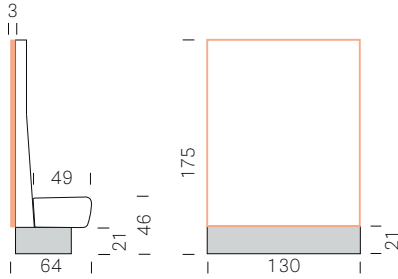

For Modus linear 100 cm  
Per Modus lineare 100 cm

**MD5\_175x100**

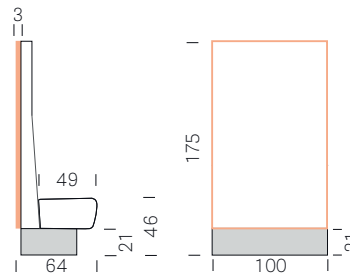

For Modus corner unit  
Per Modus angolare

**MD5\_175x134**

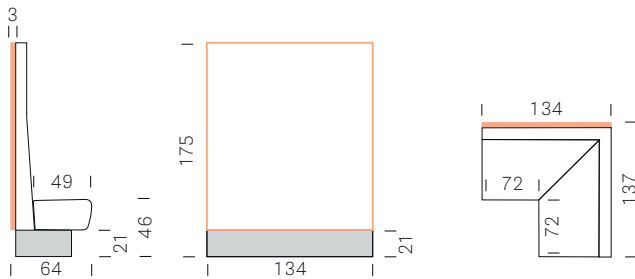

PANEL Pannello	HEIGHT Altezza	WIDTH Larghezza	FABRIC Tessuto	PRICE ** Prezzo
MD5_175x130	175	130	A	€ 549,00
MD5_175x134	175	134	C *	€ 665,00
			D40+D44	€ 731,00
			E	€ 920,00
			G	€ 920,00
			H *	€ 690,00
			N	€ 960,00
			TC	€ 549,00
			PG	€ 487,00

\*Excluding / Escluso C36+C39, C83+C89; C100+C101, C110+C122, H140+H143

\*\*Packing and back kickboard included  
Imballo e zoccolo posteriore inclusi

PANEL Pannello	HEIGHT Altezza	WIDTH Larghezza	FABRIC Tessuto	PRICE ** Prezzo
MD5_175x100	175	100	A	€ 510,00
			C *	€ 570,00
			D40+D44	€ 601,00
			E	€ 695,00
			G	€ 695,00
			H *	€ 580,00
			N	€ 715,00
			TC	€ 510,00
			PG	€ 487,00

\*Excluding / Escluso C36+C39, C83+C89; C100+C101, C110+C122, H140+H143

\*\*Packing and back kickboard included  
Imballo e zoccolo posteriore inclusi

For fabrics see page 367  
Per i tessuti si veda a p. 367

Dimensions of Modus units are expressed in centimeters  
Le misure dei moduli Modus sono espresse in centimetri

## Modus

Fabric required  
Fabbisogno tessuto

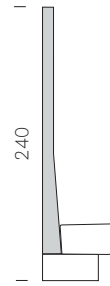
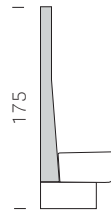
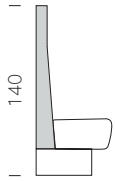
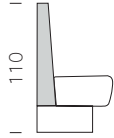
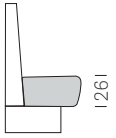

### MDL\_130

**MDWL\_130** (H110 - H140 only)

1,50 Lin Mtrs (h 1,40)

1,75 Lin Mtrs (h 1,40)

2,00 Lin Mtrs (h 1,40)

2,70 Lin Mtrs (h 1,40)

3,50 Lin Mtrs (h 1,40)

2,80 Lin Mtrs (h 1,40) Capitoné

3,80 Lin Mtrs (h 1,40) Capitoné

4,60 Lin Mtrs (h 1,40) Capitoné

### MDL\_100

**MDWL\_100** (H110 - H140 only)

1,20 Lin Mtrs (h 1,40)

1,45 Lin Mtrs (h 1,40)

1,80 Lin Mtrs (h 1,40)

2,40 Lin Mtrs (h 1,40)

3,20 Lin Mtrs (h 1,40)

2,80 Lin Mtrs (h 1,40) Capitoné

3,80 Lin Mtrs (h 1,40) Capitoné

4,60 Lin Mtrs (h 1,40) Capitoné

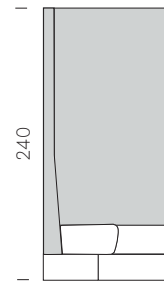
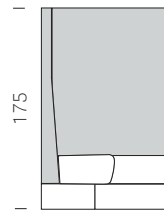
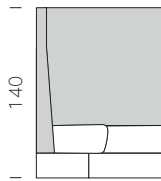
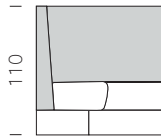
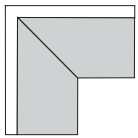

### MDA

3,00 Lin Mtrs (h 1,40)

3,50 Lin Mtrs (h 1,40)

4,00 Lin Mtrs (h 1,40)

5,30 Lin Mtrs (h 1,40)

7,00 Lin Mtrs (h 1,40)

5,60 Lin Mtrs (h 1,40) Capitoné

7,60 Lin Mtrs (h 1,40) Capitoné

9,20 Lin Mtrs (h 1,40) Capitoné

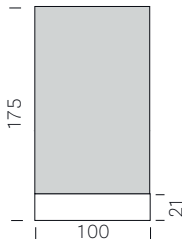
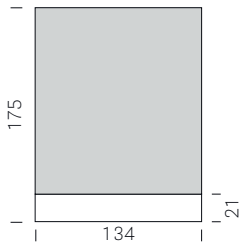
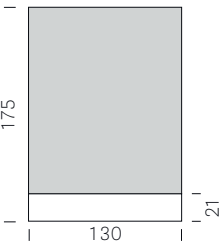

### MD5

1,75 Lin Mtrs (h 1,40)

1,80 Lin Mtrs (h 1,40)

1,70 Lin Mtrs (h 1,40)

If the bench has to be placed aside a wall, it is advisable to order the final size of the bench considering 1 cm shorter than the wall space available  
Per ordinare Modus quando esso ha un fianco appoggiato a parete, indicare la dimensione della panca desiderata sottraendo 1 cm

Pedrali denies any responsibility for problems caused by wrong measurements  
Pedrali non risponde di eventuali problemi derivanti da misurazioni errate

Dimensions of Modus units are expressed in centimeters  
Le misure dei moduli Modus sono espresse in centimetri

# Modus 2.0

Linear  
Lineare

MD/2L\_110



MD/2WL\_110



MD/2L\_110

MD/2L\_110\_L100

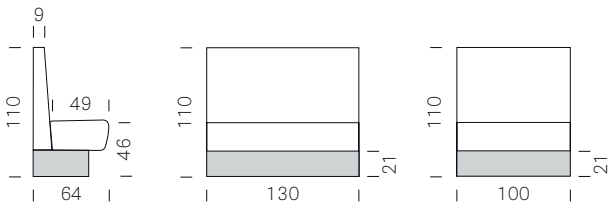

MD/2WL\_110

MD/2WL\_110\_L100

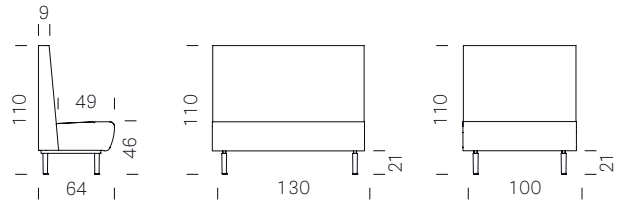

## ART. MD4

Baseboard finishes available / Zoccolo disponibile nei colori

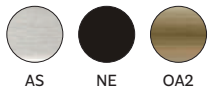

AS NE OA2

Ash wood legs / Gambe in frassino



FR N1 AN

FABRIC Tessuto	SMOOTH Liscio	HORIZONTAL STITCHES Cuciture orizzontali	VERTICAL STITCHES Cuciture verticali
A	€ 1.423,00	-	-
C *	€ 1.569,00	€ 1.602,00	€ 1.647,00
D40÷D44	€ 1.739,00	€ 1.772,00	€ 1.817,00
E	€ 1.997,00	€ 2.030,00	€ 2.075,00
G	€ 1.997,00	€ 2.030,00	€ 2.075,00
H *	€ 1.629,00	€ 1.662,00	€ 1.707,00
N	€ 2.122,00	€ 2.155,00	€ 2.200,00
TC	€ 1.423,00	€ 1.456,00	€ 1.501,00

\*Excluding / Escluso C36÷C39, C83÷C89; C100÷C101, C110÷C122, H140÷H143

Surcharge COUPLE SIDEBORD L = 44 cm (item MD4/LAT\_50) = € 90,00

Supplemento COPPIA ZOCCOLO LATERALE L = 44 cm (cod. MD4/LAT\_50) = € 90,00

For fabrics see page 367  
Per i tessuti si veda a p. 367

Dimensions of Modus units are expressed in centimeters  
Le misure dei moduli Modus sono espresse in centimetri



# Modus 2.0

Linear  
Lineare

MD/2L\_140



MD/2WL\_140

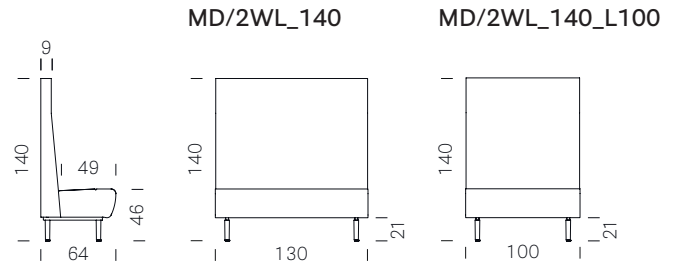
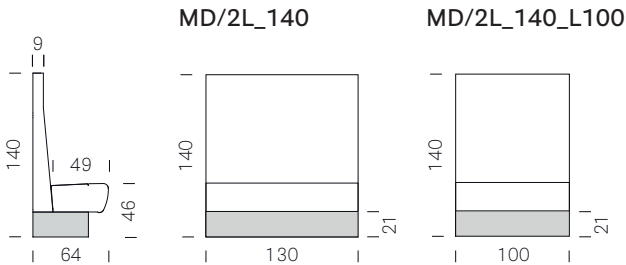

## ART. MD4

Baseboard finishes available / Zoccolo disponibile nei colori

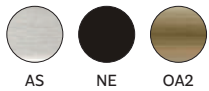

Ash wood legs / Gambe in frassino



FABRIC Tessuto	SMOOTH Liscio	HORIZONTAL STITCHES Cuciture orizzontali	VERTICAL STITCHES Cuciture verticali
A	€ 1.423,00	-	-
C *	€ 1.569,00	€ 1.602,00	€ 1.647,00
D40÷D44	€ 1.739,00	€ 1.772,00	€ 1.817,00
E	€ 1.997,00	€ 2.030,00	€ 2.075,00
G	€ 1.997,00	€ 2.030,00	€ 2.075,00
H *	€ 1.629,00	€ 1.662,00	€ 1.707,00
N	€ 2.122,00	€ 2.155,00	€ 2.200,00
TC	€ 1.423,00	€ 1.456,00	€ 1.501,00

\*Excluding / Escluso C36÷C39, C83÷C89; C100÷C101, C110÷C122, H140÷H143

Surcharge COUPLE SIDBOARD L = 44 cm (item MD4/LAT\_50) = € 90,00

Supplemento COPPIA ZOCCOLO LATERALE L = 44 cm (cod. MD4/LAT\_50) = € 90,00

For fabrics see page 367  
Per i tessuti si veda a p. 367

Dimensions of Modus units are expressed in centimeters  
Le misure dei moduli Modus sono espresse in centimetri

# Modus 2.0

Corner unit  
Angolare

MD/2A\_110



MD/2A\_140

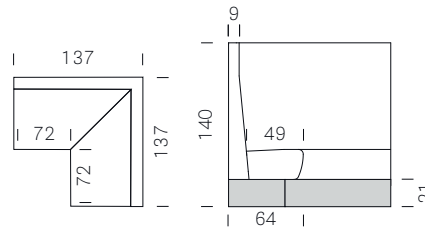
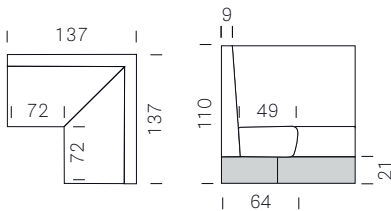

## ART. MD4

Baseboard finishes available / Zoccolo disponibile nei colori



AS NE OA2

FABRIC Tessuto	SMOOTH Liscio	HORIZONTAL STITCHES Cuciture orizzontali	VERTICAL STITCHES Cuciture verticali
A	€ 2.956,00	-	-
C *	€ 3.248,00	€ 3.314,00	€ 3.404,00
D40÷D44	€ 3.588,00	€ 3.654,00	€ 3.744,00
E	€ 4.104,00	€ 4.170,00	€ 4.260,00
G	€ 4.104,00	€ 4.170,00	€ 4.260,00
H *	€ 3.368,00	€ 3.434,00	€ 3.524,00
N	€ 4.354,00	€ 4.420,00	€ 4.510,00
TC	€ 2.956,00	€ 3.022,00	€ 3.112,00

\*Excluding / Escluso C36÷C39, C83÷C89; C100÷C101, C110÷C122, H140÷H143

Surcharge COUPLE SIDEBOARD L = 44 cm (item MD4/LAT\_50) = € 90,00

Supplemento COPPIA ZOCCOLO LATERALE L = 44 cm (cod. MD4/LAT\_50) = € 90,00

For fabrics see page 367  
Per i tessuti si veda a p. 367

Dimensions of Modus units are expressed in centimeters  
Le misure dei moduli Modus sono espresse in centimetri

# Modus 2.0

Fabric required  
Fabbisogno tessuto

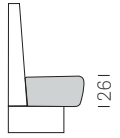

**MD/2L\_130**  
**MD/2WL\_130**

1,50 Lin Mtrs (h 1,40)

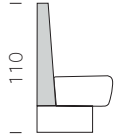

2,90 Lin Mtrs (h 1,40)

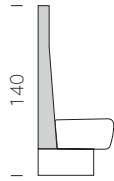

3,40 Lin Mtrs (h 1,40)

**MD/2L\_100**  
**MD/2WL\_100**

1,20 Lin Mtrs (h 1,40)

2,60 Lin Mtrs (h 1,40)

3,20 Lin Mtrs (h 1,40)

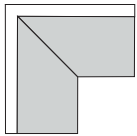

**MD/2A**

3,00 Lin Mtrs (h 1,40)

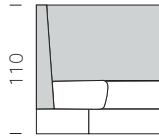

5,80 Lin Mtrs (h 1,40)

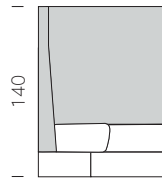

6,80 Lin Mtrs (h 1,40)

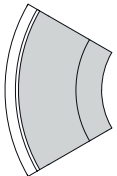

**MD/2C60**

1,50 Lin Mtrs (h 1,40)

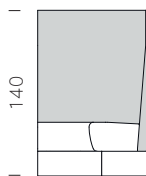

4,20 Lin Mtrs (h 1,40)

Pedrali denies any responsibility for problems caused by wrong measurements  
Pedrali non risponde di eventuali problemi derivanti da misurazioni errate

Dimensions of Modus units are expressed in centimeters  
Le misure dei moduli Modus sono espresse in centimetri

## Modus 2.0

Back shelf - Available for items MD/2L\_140, MD/2A\_140  
 Mensola posteriore - Disponibile per art. MD/2L\_140, MD/2A\_140

For Modus 2.0 linear L130, H140 cm  
 Per Modus 2.0 lineare L130, H140 cm

**K\_MD/2L\_M\_finitura\_L130**

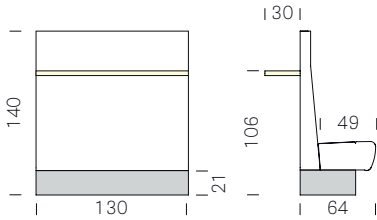

Shelf 130x30 cm, thickness 4 cm,  
 LAMINATE or FENIX, ABS edge in matching colour: **€ 198,00**

Mensola 130x30 cm, spessore 4 cm,  
 LAMINATO o FENIX, bordo ABS in tinta: **€ 198,00**

For Modus 2.0 linear L100, H140 cm  
 Per Modus 2.0 lineare L100, H140 cm

**K\_MD/2L\_M\_finitura\_L100**

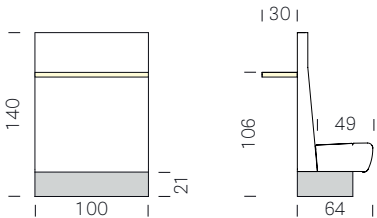

Shelf 100x30 cm, thickness 4 cm,  
 LAMINATE or FENIX, ABS edge in matching colour: **€ 198,00**

Mensola 100x30 cm, spessore 4 cm,  
 LAMINATO o FENIX, bordo ABS in tinta: **€ 198,00**

Laminate colours / Colori laminato

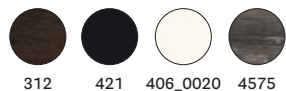

FENIX colours / Colori FENIX

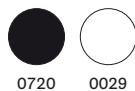

312 421 406\_0020 4575

0720 0029

Dimensions of Modus units are expressed in centimeters  
 Le misure dei moduli Modus sono espresse in centimetri

For Modus 2.0 corner unit, H140 cm  
 Per Modus 2.0 angolare, H140 cm

**K\_MD/2A\_M\_finitura\_L137**

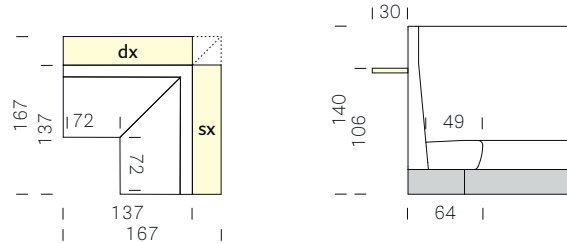

Single shelf for corner unit bench 137x30 cm, thickness 4 cm,  
 LAMINATE or FENIX, ABS edge matching colour: **€ 218,00 (single shelf)**  
 Mention the correct shelf needed: left, right or both

Mensola singola per panca angolare, 137x30 cm, spessore 4 cm,  
 LAMINATO o FENIX, bordo ABS in tinta: **€ 218,00 (mensola singola)**  
 Specificare se si necessita di mensola destra, sinistra o entrambe

**K\_MD/2A\_M\_finitura**

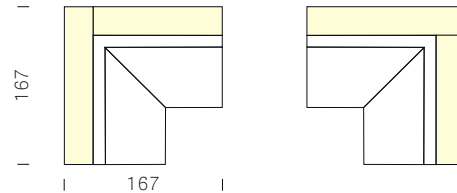

Shelf 167x167x30 cm, thickness 4 cm,  
 LAMINATE or FENIX, ABS edge in matching colour: **€ 545,00**

Mensola angolare 167x167x30 cm, spessore 4 cm,  
 LAMINATO o FENIX, bordo ABS in tinta: **€ 545,00**

# Modus 2.0



Single curved unit 60°  
Curva singola 60°  
**MD/2C60\_140**

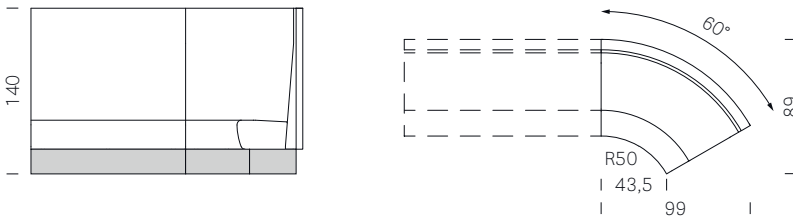

FABRIC Tessuto	SMOOTH Liscio	HORIZONTAL STITCHES Cuciture orizzontali	VERTICAL STITCHES Cuciture verticali
A	€ 1.725,00	-	-
C *	€ 1.909,00	€ 1.942,00	€ 1.942,00
D40÷D44	€ 2.123,00	€ 2.156,00	€ 2.156,00
E	€ 2.453,00	€ 2.486,00	€ 2.486,00
G	€ 2.453,00	€ 2.486,00	€ 2.486,00
H *	€ 1.984,00	€ 2.017,00	€ 2.017,00
N	€ 3.005,00	€ 3.038,00	€ 3.038,00
TC	€ 1.725,00	€ 1.758,00	€ 1.758,00

\*Excluding / Escluso C36+C39, C83+C89; C100+C101, C110+C122, H140+H143

The single curved unit is not free standing. It must be combined with another linear or curved unit Modus 2.0  
La curva singola non è autoportante. Va abbinata a un modulo lineare o a una curva Modus 2.0

Double curved unit 60°  
Doppia curva singola 60°  
**MD/2C60\_140 (2 pcs/pz)**

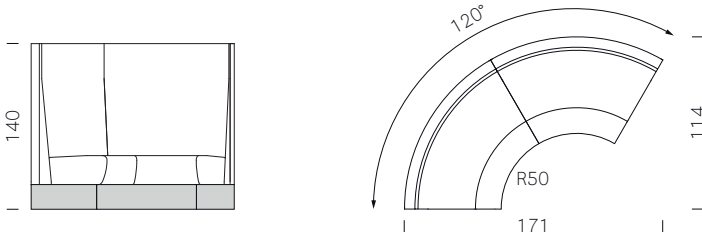

FABRIC Tessuto	SMOOTH Liscio	HORIZONTAL STITCHES Cuciture orizzontali	VERTICAL STITCHES Cuciture verticali
A	€ 3.450,00	-	-
C *	€ 3.817,00	€ 3.883,00	€ 3.883,00
D40÷D44	€ 4.246,00	€ 4.312,00	€ 4.312,00
E	€ 4.906,00	€ 4.972,00	€ 4.972,00
G	€ 4.906,00	€ 4.972,00	€ 4.972,00
H *	€ 3.967,00	€ 4.033,00	€ 4.033,00
N	€ 5.217,00	€ 5.283,00	€ 5.283,00
TC	€ 3.450,00	€ 3.516,00	€ 3.516,00

\*Excluding / Escluso C36+C39, C83+C89; C100+C101, C110+C122, H140+H143

## ART. MD4

Baseboard finishes available / Zoccolo disponibile nei colori



Surcharge COUPLE SIDEBBOARD L = 44 cm (item MD4/LAT\_50) = € 90,00  
Supplemento COPPIA ZOCCOLO LATERALE L = 44 cm (cod. MD4/LAT\_50) = € 90,00

For fabrics see page 367  
Per i tessuti si veda a p. 367

Dimensions of Modus units are expressed in centimeters  
Le misure dei moduli Modus sono espresse in centimetri

## Modus 2.0

Triple curved unit 60°  
Tripla curva singola 60°

MD/2C60\_140 (3 pcs/pz)

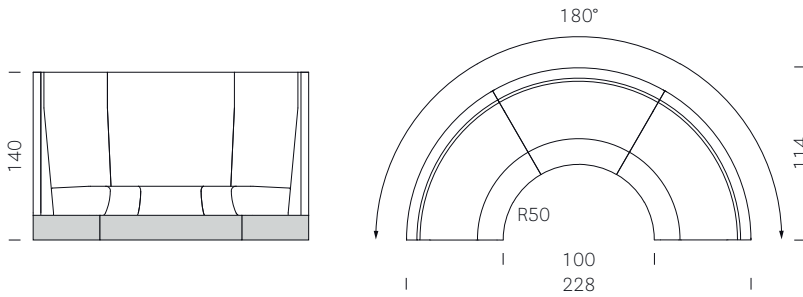

FABRIC Tessuto	SMOOTH Liscio	HORIZONTAL STITCHES Cuciture orizzontali	VERTICAL STITCHES Cuciture verticali
A	€ 5.175,00	-	-
C *	€ 5.726,00	€ 5.825,00	€ 5.825,00
D40÷D44	€ 6.369,00	€ 6.468,00	€ 6.468,00
E	€ 7.359,00	€ 7.458,00	€ 7.458,00
G	€ 7.359,00	€ 7.458,00	€ 7.458,00
H *	€ 5.950,00	€ 6.049,00	€ 6.049,00
N	€ 7.825,00	€ 7.924,00	€ 7.924,00
TC	€ 5.175,00	€ 5.274,00	€ 5.274,00

\*Excluding / Escluso C36+C39, C83+C89; C100+C101, C110+C122, H140+H143

Quadruple curved unit 60°  
Quadrupla curva singola 60°

MD/2C60\_140 (4 pcs/pz)

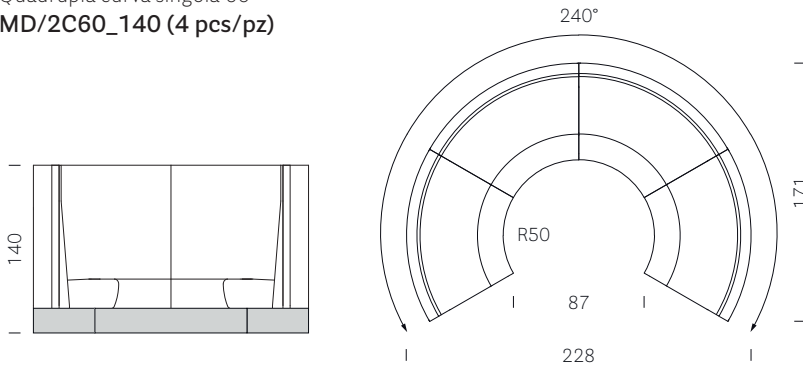

FABRIC Tessuto	SMOOTH Liscio	HORIZONTAL STITCHES Cuciture orizzontali	VERTICAL STITCHES Cuciture verticali
A	€ 6.900,00	-	-
C *	€ 7.634,00	€ 7.766,00	€ 7.766,00
D40÷D44	€ 8.492,00	€ 8.624,00	€ 8.624,00
E	€ 9.812,00	€ 9.944,00	€ 9.944,00
G	€ 9.812,00	€ 9.944,00	€ 9.944,00
H *	€ 7.934,00	€ 8.066,00	€ 8.066,00
N	€ 10.433,00	€ 10.565,00	€ 10.565,00
TC	€ 6.900,00	€ 7.032,00	€ 7.032,00

\*Excluding / Escluso C36+C39, C83+C89; C100+C101, C110+C122, H140+H143

### ART. MD4

Baseboard finishes available / Zoccolo disponibile nei colori



AS NE OA2

Surcharge COUPLE SIDEBBOARD L = 44 cm (item MD4/LAT\_50) = € 90,00

Supplemento COPPIA ZOCCOLO LATERALE L = 44 cm (cod. MD4/LAT\_50) = € 90,00

For fabrics see page 367  
Per i tessuti si veda a p. 367

Dimensions of Modus units are expressed in centimeters  
Le misure dei moduli Modus sono espresse in centimetri

# Modus 2.0

Back curved shelf  
Mensola posteriore curva

For Modus 2.0 curved, H140 cm  
Per Modus 2.0 curva, H140 cm

K\_MD/2C60\_M\_finitura\_R\_50

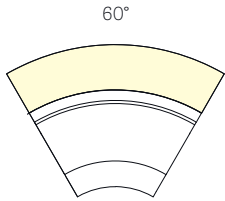

Single curved shelf, thickness 4 cm,  
LAMINATE or FENIX, ABS edge in matching colour: **€ 348,00**

Mensola curva, singola, spessore 4 cm,  
LAMINATO o FENIX, bordo ABS in tinta: **€ 348,00**

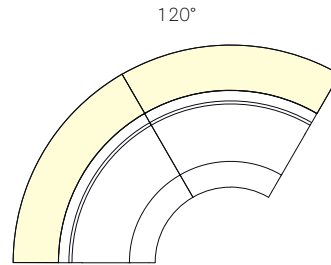

Double curved shelf, thickness 4 cm,  
LAMINATE or FENIX, ABS edge in matching colour: **€ 696,00**

Mensola curva, doppia, spessore 4 cm,  
LAMINATO o FENIX, bordo ABS in tinta: **€ 696,00**

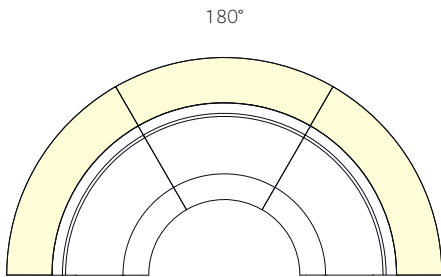

Triple curved shelf, thickness 4 cm,  
LAMINATE or FENIX, ABS edge in matching colour: **€ 1.044,00**

Mensola curva, tripla, spessore 4 cm,  
LAMINATO o FENIX, bordo ABS in tinta: **€ 1.044,00**

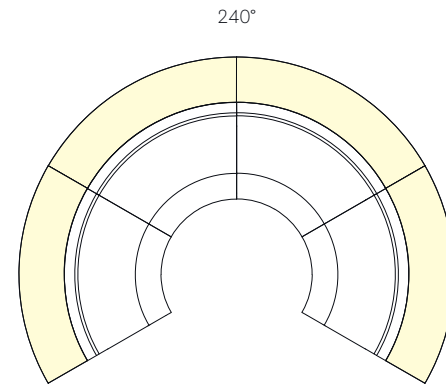

Quadruple curved shelf, thickness 4 cm,  
LAMINATE or FENIX, ABS edge in matching colour: **€ 1.392,00**

Mensola curva, quadrupla, spessore 4 cm,  
LAMINATO o FENIX, bordo ABS in tinta: **€ 1.392,00**

Laminate colours / Colori laminato

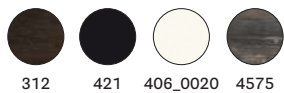

FENIX colours / Colori FENIX

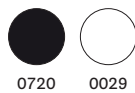

## Mood 720



SEAT Sedile	BACK Schienale	FRAME Telaio	LEATHER Cuoio
F01; F05+F09	F01; F05+F09	F01; F05+F09	<b>€ 497,00</b>

GENUINE LEATHER FINISHES / Finiture cuoio naturale

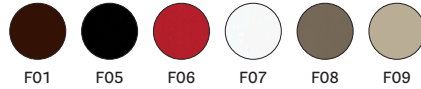

PACKING / Imballo



TECHNICAL DETAILS / Dettagli tecnici

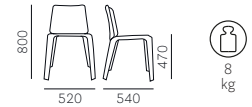

## Mya 700



SEAT Sedile	BACK Schienale	POWDER COATED Verniciato	POLISHED ALUMINIUM Alluminio lucidato	BRUSHED ALUMINIUM Alluminio satinato
PPL	PPL	<b>€ 164,00</b>	<b>€ 204,00</b>	<b>€ 204,00</b>

PPL FINISHES / Finiture PPL



PACKING / Imballo



TECHNICAL DETAILS / Dettagli tecnici

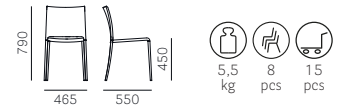

SAFETY, STRENGTH and DURABILITY TESTS  
Prove di sicurezza, resistenza e durata  
EN 1728:2000

## Mya 701

TECNICA



SEAT Sedile	BACK Schienale	POWDER COATED Verniciato	POLISHED ALUMINIUM Alluminio lucidato	BRUSHED ALUMINIUM Alluminio satinato
PPL	TXT	<b>€ 176,00</b>	<b>€ 216,00</b>	<b>€ 216,00</b>

PPL FINISHES / Finiture PPL

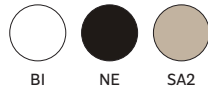

TXT FINISHES / Finiture TXT

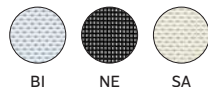

PACKING / Imballo



TECHNICAL DETAILS / Dettagli tecnici

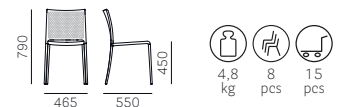

SAFETY, STRENGTH and DURABILITY TESTS  
Prove di sicurezza, resistenza e durata  
EN 1728:2000

For colours and finishes see at page 362  
Per colori e finiture vedere da pagina 362



## GC

Linking device  
Gancio di collegamento



FRAME Telaio	CHROMED Cromato
Ø 6	<p><b>€ 28,00</b> For chairs / Per sedie MYA 700, 701</p>

### TECHNICAL DETAILS / Dettagli tecnici

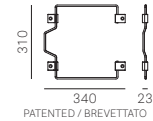

## Mya 702

TECNICA



SEAT Sedile	BACK Schienale	POLISHED ALUMINIUM Alluminio lucidato	BRUSHED ALUMINIUM Alluminio satinato
A		<b>€ 283,00</b>	<b>€ 283,00</b>
H20+H35; H100+H108	TXT	<b>€ 291,00</b>	<b>€ 291,00</b>
P*		<b>€ 345,00</b>	<b>€ 345,00</b>

\*Excluding / Escluso PBS-PCO-PMS-PVE

### TXT FINISHES / Finiture TXT

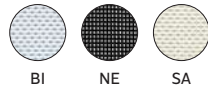

For fabrics see page 367  
Per i tessuti si veda a p. 367

### PACKING / Imballo



### TECHNICAL DETAILS / Dettagli tecnici

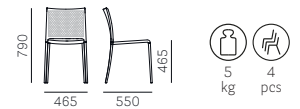

SAFETY, STRENGTH and DURABILITY TESTS  
Prove di sicurezza, resistenza e durata  
EN 1728:2000

## Mya 710

SOFT



SEAT Sedile	BACK Schienale	POLISHED ALUMINIUM Alluminio lucidato	BRUSHED ALUMINIUM Alluminio satinato
A	A	<b>€ 338,00</b>	<b>€ 338,00</b>
H20+H35; H100+H108 H82+H89	H20+H35; H100+H108 H82+H89	<b>€ 376,00</b>	<b>€ 376,00</b>
P*	P*	<b>€ 463,00</b>	<b>€ 463,00</b>

\*Excluding / Escluso PBS-PCO-PMS-PVE

For fabrics see page 367  
Per i tessuti si veda a p. 367

### PACKING / Imballo



### TECHNICAL DETAILS / Dettagli tecnici



SAFETY, STRENGTH and DURABILITY TESTS  
Prove di sicurezza, resistenza e durata  
EN 1728:2000

## Mya 711

SOFT



SEAT Sedile	BACK Schienale	BLACK POWDER COATED Verniciato nero	POLISHED ALUMINIUM Alluminio lucidato	BRUSHED ALUMINIUM Alluminio satinato
A	A + PPL	€ 239,00	€ 279,00	€ 279,00
H20+H35; H100+H108	H20+H35; H100+H108 + PPL	€ 269,00	€ 309,00	€ 309,00
H82+H89	H82+H89 + PPL			

For fabrics see page 367  
Per i tessuti si veda a p. 367

PACKING / Imballo



TECHNICAL DETAILS / Dettagli tecnici



SAFETY, STRENGTH and DURABILITY TESTS  
Prove di sicurezza, resistenza e durata  
EN 1728:2000

## Mya 705/2



SEAT Sedile	BACK Schienale	POWDER COATED Verniciato	BRUSHED ALUMINIUM Alluminio satinato
PPL	PPL	€ 249,00	€ 325,00

PPL FINISHES / Finiture PPL



PACKING / Imballo



TECHNICAL DETAILS / Dettagli tecnici

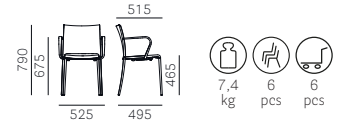

## Mya 706/2

TECNICA



SEAT Sedile	BACK Schienale	POWDER COATED Verniciato	BRUSHED ALUMINIUM Alluminio satinato
PPL	TXT	€ 261,00	€ 337,00

PPL FINISHES / Finiture PPL

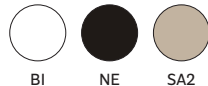

TXT FINISHES / Finiture TXT

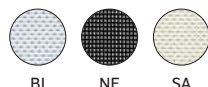

For colours and finishes see at page 362  
Per colori e finiture vedere da pagina 362

PACKING / Imballo



TECHNICAL DETAILS / Dettagli tecnici

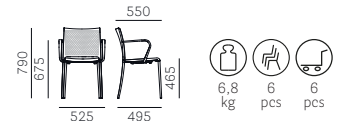

# Mya 710/2

SOFT



SEAT Sedile	BACK Schienale	BRUSHED ALUMINIUM Alluminio satinato
A	A	€ 459,00
H20+H35; H100+H108 H82+H89	H20+H35; H100+H108 H82+H89	€ 497,00
P*	P*	€ 584,00

\*Excluding / Escluso PBS-PCO-PMS-PVE

For fabrics see page 367  
Per i tessuti si veda a p. 367

PACKING / Imballo



TECHNICAL DETAILS / Dettagli tecnici



# Nemea 2820



SEAT Sedile	BACK Schienale	FRAME Telaio	ASH Frassino	ASH STAINED ON SAMPLE Frassino tinto campione
FR-N1-GC- BI-AN	FR-N1-GC- BI-AN	FR-N1-GC- BI-AN	€ 278,00	
TC	TC	TC		€ 301,00

Black powder coated die-casted aluminium, white powder coated for FR and BI version only  
Pressofusione di alluminio verniciato nero, verniciato bianco solo per versione FR e BI

Minimum order q.ty: 20 pcs  
Ordine minimo: 20pz

FINISHES / Finiture



PACKING / Imballo



TECHNICAL DETAILS / Dettagli tecnici



SAFETY, STRENGTH and DURABILITY TESTS  
Prove di sicurezza, resistenza e durata  
EN 1728:2012+AC2013  
EN 16139:2013 level 2

# Nemea 2820



SEAT Sedile	BACK Schienale	FRAME Telaio	ASH Frassino
BL2 AZ1 VE2 VE1 RB RA MO MC	BL2 AZ1 VE2 VE1 RB RA MO MC	BL2 AZ1 VE2 VE1 RB RA MO MC	€ 289,00 Lacquered with visible grains Laccato a poro aperto

Black powder coated die-casted aluminium, powder-coated in matching colour for RB version only  
Pressofusione di alluminio verniciato nero, verniciata in tinta solo per versione RB

FINISHES / Finiture

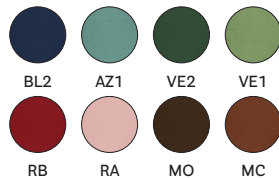

PACKING / Imballo



TECHNICAL DETAILS / Dettagli tecnici



SAFETY, STRENGTH and DURABILITY TESTS  
Prove di sicurezza, resistenza e durata  
EN 1728:2012+AC2013  
EN 16139:2013 level 2



PRODUCT CERTIFIED  
FOR LOW CHEMICAL  
EMISSIONS:  
UL.COM/GG  
UL 2818



PRODUCT CERTIFIED  
FOR LOW CHEMICAL  
EMISSIONS:  
UL.COM/GG  
UL 2818

## Nemea 2821



SEAT Sedile	BACK Schienale	FRAME Telaio	ASH Frassino	ASH STAINED ON SAMPLE Frassino tinto campione
A			€ 315,00	€ 338,00
C*			€ 327,00	€ 350,00
D40÷D44	FR-N1-GC- BI-AN	FR-N1-GC- BI-AN	€ 340,00	€ 363,00
G			€ 362,00	€ 385,00
H*	TC	TC	€ 331,00	€ 354,00
P*			€ 375,00	€ 398,00
TC**			€ 315,00	€ 338,00

\*\*TC = Minimum order 10 pcs each fabric colour  
TC = Ordine minimo 10 pz per colore/tessuto

Black powder coated die-casted aluminum, white powder coated for FR and BI version only  
Pressofusione di alluminio verniciato nero, verniciato bianco solo per versione FR e BI

\*Excluding / Escluso C36÷C39, H140+H143, PBS-PCO-PMS-PVE

For fabrics see page 367  
Per i tessuti si veda a p. 367

PACKING / Imballo



FABRIC REQUIRED / Fabbisogno tessuto  
1pc: Lin Mtrs 0,60 (h 1,40)

TECHNICAL DETAILS / Dettagli tecnici



SAFETY, STRENGTH and DURABILITY TESTS  
Prove di sicurezza, resistenza e durata  
EN 1728:2012+AC2013  
EN 16139:2013 level 2

FINISHES / Finiture



## Nemea 2825



SEAT Sedile	BACK Schienale	FRAME Telaio	ASH Frassino	ASH STAINED ON SAMPLE Frassino tinto campione
FR-N1-GC- BI-AN	FR-N1-GC- BI-AN	FR-N1-GC- BI-AN	€ 293,00	
TC	TC	TC		€ 316,00

Black powder coated die-casted aluminium, white powder coated for FR and BI version only  
Pressofusione di alluminio verniciato nero, verniciato bianco solo per versione FR e BI

Minimum order q.ty: 20 pcs  
Ordine minimo: 20pz

FINISHES / Finiture

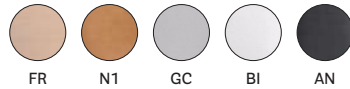

PACKING / Imballo



TECHNICAL DETAILS / Dettagli tecnici



SAFETY, STRENGTH and DURABILITY TESTS  
Prove di sicurezza, resistenza e durata  
EN 1728:2012+AC2013  
EN 16139:2013 level 2

## Nemea 2825



SEAT Sedile	BACK Schienale	FRAME Telaio	ASH Frassino
BL2	BL2	BL2	€ 304,00 Lacquered with visible grains Laccato a poro aperto
AZ1	AZ1	AZ1	
VE2	VE2	VE2	
VE1	VE1	VE1	
RB	RB	RB	
RA	RA	RA	
MO	MO	MO	
MC	MC	MC	

Black powder coated die-casted aluminium, powder-coated in matching colour for RB version only  
Pressofusione di alluminio verniciato nero, verniciata in tinta solo per versione RB

FINISHES / Finiture

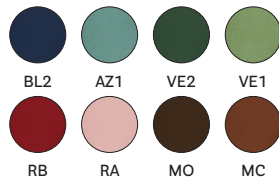

PACKING / Imballo



TECHNICAL DETAILS / Dettagli tecnici



SAFETY, STRENGTH and DURABILITY TESTS  
Prove di sicurezza, resistenza e durata  
EN 1728:2012+AC2013  
EN 16139:2013 level 2



## Nemea 2826



SEAT Sedile	BACK Schienale	FRAME Telaio	ASH Frassino	ASH STAINED ON SAMPLE Frassino tinto campione
A			€ 325,00	€ 349,00
C*			€ 337,00	€ 360,00
D40+D44	FR-N1-GC- BI-AN	FR-N1-GC- BI-AN	€ 351,00	€ 374,00
G			€ 373,00	€ 396,00
H*	TC	TC	€ 341,00	€ 364,00
P*			€ 385,00	€ 408,00
TC**			€ 325,00	€ 349,00

\*\*TC = Minimum order 10 pcs each fabric colour  
TC = Ordine minimo 10 pz per colore/tessuto

Black powder coated die-casted aluminum, white powder coated for FR and BI version only  
Pressofusione di alluminio verniciato nero, verniciato bianco solo per versione FR e BI

\*Excluding / Escluso C36+C39, H140+H143, PBS-PCO-PMS-PVE

For fabrics see page 367  
Per i tessuti si veda a p. 367

PACKING / Imballo



FABRIC REQUIRED / Fabbisogno tessuto  
1pc: Lin Mtrs 0,60 (h 1,40)

Minimum order q.ty: 20 pcs  
Ordine minimo: 20pz

FINISHES / Finiture

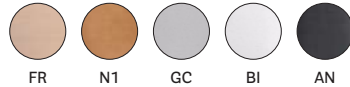

TECHNICAL DETAILS / Dettagli tecnici



SAFETY, STRENGTH and DURABILITY TESTS  
Prove di sicurezza, resistenza e durata  
EN 1728:2012+AC2013  
EN 16139:2013 level 2



## Noa 725



SEAT Sedile	BACK Schienale	FRAME Telaio	WHITE/BLACK POWDER COATED Verniciato bianco/nero	CHROMED Cromato
C36+C39 C83+C89; C100+C101 C110+C122 C130+C141 C210+C217	C36+C39 C83+C89; C100+C101 C110+C122 C130+C141 C210+C217	Ø 16	€ 249,00	€ 249,00
G	G		€ 296,00	€ 296,00
H*	H*		€ 257,00	€ 257,00

\*Excluding / Escluso H140+H143

For fabrics see page 367  
Per i tessuti si veda a p. 367

PACKING / Imballo



For fabrics see page 367  
Per i tessuti si veda a p. 367

PC FINISHES / Finiture PC

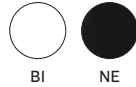

TECHNICAL DETAILS / Dettagli tecnici

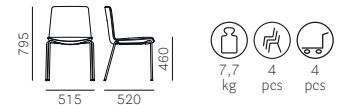

SAFETY, STRENGTH and DURABILITY TESTS  
Prove di sicurezza, resistenza e durata  
EN 1728:2000

## Noa 727



SEAT Sedile	BACK Schienale	FRAME Telaio	WHITE/BLACK POWDER COATED Verniciato bianco/nero	POLISHED ALUMINIUM Alluminio lucidato
C36+C39 C83+C89; C100+C101 C110+C122 C130+C141 C210+C217	C36+C39 C83+C89; C100+C101 C110+C122 C130+C141 C210+C217	Ø 680	€ 332,00	€ 365,00
G	G		€ 379,00	€ 412,00
H*	H*		€ 340,00	€ 373,00

\*Excluding / Escluso H140+H143

For fabrics see page 367  
Per i tessuti si veda a p. 367

PACKING / Imballo



For fabrics see page 367  
Per i tessuti si veda a p. 367

PC FINISHES / Finiture PC

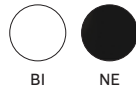

TECHNICAL DETAILS / Dettagli tecnici



Polycarbonate outer shell, upholstered inner shell  
Scocca esterna in policarbonato, scocca interna imbottita

## Noa 727/2



SEAT Sedile	BACK Schienale	FRAME Telaio	WHITE/BLACK POWDER COATED Verniciato bianco/nero	POLISHED ALUMINIUM Alluminio lucidato
C36+C39 C83+C89; C100+C101 C110+C122 C130+C141 C210+C217	C36+C39 C83+C89; C100+C101 C110+C122 C130+C141 C210+C217	Ø 680	<b>€ 354,00</b>	<b>€ 387,00</b>
G	G		<b>€ 401,00</b>	<b>€ 434,00</b>
H *	H *		<b>€ 362,00</b>	<b>€ 395,00</b>

\*Excluding / Escluso H140+H143

PC FINISHES / Finiture PC

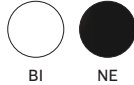

Polycarbonate outer shell, upholstered inner shell  
Scocca esterna in policarbonato, scocca interna imbottita

For fabrics see page 367  
Per i tessuti si veda a p. 367

PACKING / Imballo



TECHNICAL DETAILS / Dettagli tecnici



## Noa 727/4

Gas lift device  
Alzata a gas



SEAT Sedile	BACK Schienale	FRAME Telaio	WHITE/BLACK POWDER COATED Verniciato bianco/nero	POLISHED ALUMINIUM Alluminio lucidato
C36+C39 C83+C89; C100+C101 C110+C122 C130+C141 C210+C217	C36+C39 C83+C89; C100+C101 C110+C122 C130+C141 C210+C217	Ø 750	<b>€ 370,00</b>	<b>€ 431,00</b>
G	G		<b>€ 417,00</b>	<b>€ 478,00</b>
H *	H *		<b>€ 378,00</b>	<b>€ 439,00</b>

\*Excluding / Escluso H140+H143

PC FINISHES / Finiture PC



Polycarbonate outer shell, upholstered inner shell  
Scocca esterna in policarbonato, scocca interna imbottita

For fabrics see page 367  
Per i tessuti si veda a p. 367

PACKING / Imballo



TECHNICAL DETAILS / Dettagli tecnici



## Noa 726



SEAT Sedile	BACK Schienale	FRAME Telaio	WHITE/BLACK POWDER COATED Verniciato bianco/nero	CHROMED Cromato
C36+C39 C83+C89; C100+C101 C110+C122 C130+C141 C210+C217	C36+C39 C83+C89; C100+C101 C110+C122 C130+C141 C210+C217	Ø 16	<b>€ 353,00</b>	<b>€ 353,00</b>
G	G		<b>€ 400,00</b>	<b>€ 400,00</b>
H *	H *		<b>€ 361,00</b>	<b>€ 361,00</b>

\* Excluding / Escluso H140+H143

PC FINISHES / Finiture PC

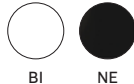

Polycarbonate outer shell, upholstered inner shell  
Scocca esterna in policarbonato, scocca interna imbottita

For fabrics see page 367  
Per i tessuti si veda a p. 367

PACKING / Imballo



TECHNICAL DETAILS / Dettagli tecnici



SAFETY, STRENGTH and DURABILITY TESTS  
Prove di sicurezza, resistenza e durata  
EN 1728:2000

## Noa 728



SEAT Sedile	BACK Schienale	FRAME Telaio	WHITE/BLACK POWDER COATED Verniciato bianco/nero	POLISHED ALUMINIUM Alluminio lucidato
C36+C39 C83+C89; C100+C101 C110+C122 C130+C141 C210+C217	C36+C39 C83+C89; C100+C101 C110+C122 C130+C141 C210+C217	Ø 680	€ 435,00	€ 468,00
G	G		€ 482,00	€ 515,00
H *	H *		€ 443,00	€ 476,00

The armrest frame is always powder coated in white or black colour, to match the outer shell  
Il telaio del bracciolo è sempre verniciato bianco o nero, in tinta con la scocca esterna

\*Excluding / Escluso H140+H143

For fabrics see page 367  
Per i tessuti si veda a p. 367

PC FINISHES / Finiture PC

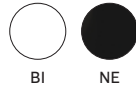

Polycarbonate outer shell, upholstered inner shell  
Scocca esterna in policarbonato, scocca interna imbottita

PACKING / Imballo



TECHNICAL DETAILS / Dettagli tecnici



## Noa 728/2



SEAT Sedile	BACK Schienale	FRAME Telaio	WHITE/BLACK POWDER COATED Verniciato bianco/nero	POLISHED ALUMINIUM Alluminio lucidato
C36+C39 C83+C89; C100+C101 C110+C122 C130+C141 C210+C217	C36+C39 C83+C89; C100+C101 C110+C122 C130+C141 C210+C217	Ø 680	€ 457,00	€ 490,00
G	G		€ 504,00	€ 537,00
H *	H *		€ 465,00	€ 498,00

The armrest frame is always powder coated in white or black colour, to match the outer shell  
Il telaio del bracciolo è sempre verniciato bianco o nero, in tinta con la scocca esterna

\*Excluding / Escluso H140+H143

For fabrics see page 367  
Per i tessuti si veda a p. 367

PC FINISHES / Finiture PC

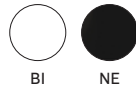

Polycarbonate outer shell, upholstered inner shell  
Scocca esterna in policarbonato, scocca interna imbottita

PACKING / Imballo



TECHNICAL DETAILS / Dettagli tecnici



## Noa 728/4

Gas lift device  
Alzata a gas



SEAT Sedile	BACK Schienale	FRAME Telaio	WHITE/BLACK POWDER COATED Verniciato bianco/nero	POLISHED ALUMINIUM Alluminio lucidato
C36+C39 C83+C89; C100+C101 C110+C122 C130+C141 C210+C217	C36+C39 C83+C89; C100+C101 C110+C122 C130+C141 C210+C217	Ø 750	€ 474,00	€ 534,00
G	G		€ 521,00	€ 581,00
H *	H *		€ 482,00	€ 542,00

The armrest frame is always powder coated in white or black colour, to match the outer shell  
Il telaio del bracciolo è sempre verniciato bianco o nero, in tinta con la scocca esterna

\*Excluding / Escluso H140+H143

For fabrics see page 367  
Per i tessuti si veda a p. 367

PC FINISHES / Finiture PC

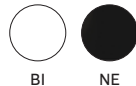

Polycarbonate outer shell, upholstered inner shell  
Scocca esterna in policarbonato, scocca interna imbottita

PACKING / Imballo



TECHNICAL DETAILS / Dettagli tecnici



## Nolita 3650

Low back  
Schienale basso



SEAT Sedile	BACK Schienale	FRAME Telaio	POWDER COATED Verniciato
METAL Ø 6	METAL Ø 6	METAL Ø 16	€ 116,00

FINISHES / Finiture



PACKING / Imballo



TECHNICAL DETAILS / Dettagli tecnici



SAFETY, STRENGTH and DURABILITY TESTS  
Prove di sicurezza, resistenza e durata  
EN 1728:2012+AC2013  
EN 16139:2013 level 2



## Nolita 3651

High back  
Schienale alto



SEAT Sedile	BACK Schienale	FRAME Telaio	POWDER COATED Verniciato
METAL Ø 6	METAL Ø 6	METAL Ø 16	€ 125,00

FINISHES / Finiture



PACKING / Imballo



TECHNICAL DETAILS / Dettagli tecnici

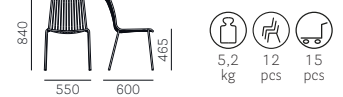

SAFETY, STRENGTH and DURABILITY TESTS  
Prove di sicurezza, resistenza e durata  
EN 1728:2012+AC2013  
EN 16139:2013 level 2



## Nolita 3655

Low back  
Schienale basso



SEAT Sedile	BACK Schienale	FRAME Telaio	POWDER COATED Verniciato
METAL Ø 6	METAL Ø 6	METAL Ø 16	€ 136,00

FINISHES / Finiture



PACKING / Imballo



TECHNICAL DETAILS / Dettagli tecnici

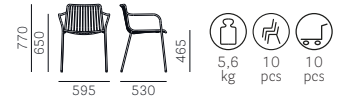

SAFETY, STRENGTH and DURABILITY TESTS  
Prove di sicurezza, resistenza e durata  
EN 1728:2012+AC2013  
EN 16139:2013 level 2





## Nolita 3656

High back  
Schienale alto



SEAT Sedile	BACK Schienale	FRAME Telaio	POWDER COATED Verniciato
METAL Ø 6	METAL Ø 6	METAL Ø 16	<b>€ 145,00</b>

### FINISHES / Finiture



**SAFETY, STRENGTH and DURABILITY TESTS**  
Prove di sicurezza, resistenza e durata  
EN 1728:2012+AC2013  
EN 16139:2013 level 2

### PACKING / Imballo



### TECHNICAL DETAILS / Dettagli tecnici



## Nolita 3650.3

Cushion only  
Solo cuscino



SEAT Sedile	FABRIC Tessuto
D22+D26 D80+D89 D100+D105 D110+D115 D130+D133	<b>€ 66,00</b> For chairs/armchairs Per sedie/poltrone 3650, 3651, 3655, 3656

For fabrics see page 367  
Per i tessuti si veda a p. 367

### RIM COLOURS / Colori bordino



### PACKING / Imballo



### TECHNICAL DETAILS / Dettagli tecnici

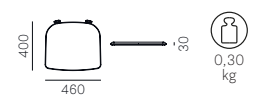

## Nolita 3657



SEAT Sedile	BACK Schienale	FRAME Telaio	POWDER COATED Verniciato
METAL Ø 6	METAL Ø 6	METAL Ø 16 H650	<b>€ 132,00</b>

### FINISHES / Finiture



**SAFETY, STRENGTH and DURABILITY TESTS**  
Prove di sicurezza, resistenza e durata  
EN 1728:2012+AC2013  
EN 16139:2013 level 2

### PACKING / Imballo



### TECHNICAL DETAILS / Dettagli tecnici

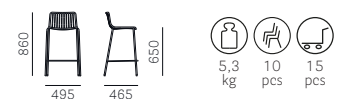

## Nolita 3658



SEAT Sedile	BACK Schienale	FRAME Telaio	POWDER COATED Verniciato
METAL Ø 6	METAL Ø 6	METAL Ø 16 H750	<b>€ 139,00</b>

FINISHES / Finiture



PACKING / Imballo



TECHNICAL DETAILS / Dettagli tecnici

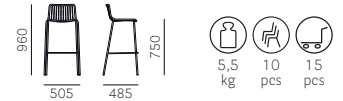

## Nolita 3657.3

Cushion only  
Solo cuscino



SEAT Sedile	FABRIC Tessuto
D22+D26 D80+D89 D100+D105 D110+D115 D130+D133	<b>€ 66,00</b> For stools Per sgabelli 3657, 3658

For fabrics see page 367  
Per i tessuti si veda a p. 367

RIM COLOURS / Colori bordino

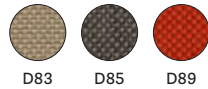

PACKING / Imballo



TECHNICAL DETAILS / Dettagli tecnici

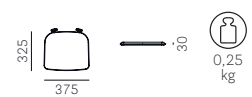

## Nolita 3659

LOUNGE



SEAT Sedile	BACK Schienale	FRAME Telaio	POWDER COATED Verniciato
METAL Ø 6	METAL Ø 6	METAL Ø 16	<b>€ 154,00</b>

FINISHES / Finiture



PACKING / Imballo



TECHNICAL DETAILS / Dettagli tecnici



## Nolita 3659.3

LOUNGE  
Cushion only  
Solo cuscino



SEAT  
Sedile

D22+D26  
D80+D89  
D100+D105  
D110+D115  
D130+D133

FABRIC  
Tessuto

€ 66,00  
For armchair  
Per poltrona  
3659

For fabrics see page 367  
Per i tessuti si veda a p. 367

RIM COLOURS / Colori bordino

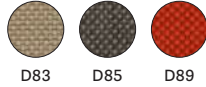

D83 D85 D89

PACKING / Imballo



TECHNICAL DETAILS / Dettagli tecnici



## Nolita 3654

CHAISE LONGUE



SEAT  
Sedile

METAL  
Ø 6

BACK  
Schienale

METAL  
Ø 6

FRAME  
Telaio

METAL  
Ø 20

POWDER COATED  
Verniciato

€ 660,00

FINISHES / Finiture



B1200E G1100E AR500E RO200E TEE RA100E  
NPE GAE AZ100E BL300E BL500E VE100E VE600E

PACKING / Imballo



TECHNICAL DETAILS / Dettagli tecnici



## Nolita 3654.7

CHAISE LONGUE  
Cushion only  
Solo cuscino



SEAT  
Sedile

D22+D26  
D80+D89  
D100+D105  
D110+D115  
D130+D133

FABRIC  
Tessuto

€ 369,00

For fabrics see page 367  
Per i tessuti si veda a p. 367

RIM COLOURS / Colori bordino

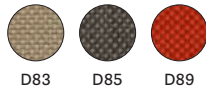

D83 D85 D89

PACKING / Imballo



TECHNICAL DETAILS / Dettagli tecnici

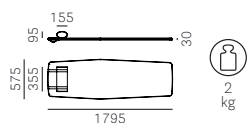



**Couple of linking devices included**  
Inclusa una coppia di ganci di collegamento

CODE Codice	SEAT Sedile	BACK Schienale	FRAME Telaio	POWDER COATED Verniciato
<b>DN001</b> Linear Lineare	D22+D26 D80+D89 D100+D105 D110+D115 D130+D133	D22+D26 D80+D89 D100+D105 D110+D115 D130+D133	METAL Ø 20	<b>€ 1.150,00</b>
<b>DN002</b> Right corner (with armrest cushion) Angolare destro (con cuscino bracciolo)	D22+D26 D80+D89 D100+D105 D110+D115 D130+D133	D22+D26 D80+D89 D100+D105 D110+D115 D130+D133	METAL Ø 20	<b>€ 1.450,00</b>
<b>DN003</b> Left corner (with armrest cushion) Angolare sinistro (con cuscino bracciolo)	D22+D26 D80+D89 D100+D105 D110+D115 D130+D133	D22+D26 D80+D89 D100+D105 D110+D115 D130+D133	METAL Ø 20	<b>€ 1.450,00</b>
<b>DN004</b> Right corner Angolare destro	D22+D26 D80+D89 D100+D105 D110+D115 D130+D133	D22+D26 D80+D89 D100+D105 D110+D115 D130+D133	METAL Ø 20	<b>€ 1.280,00</b>
<b>DN005</b> Left corner Angolare sinistro	D22+D26 D80+D89 D100+D105 D110+D115 D130+D133	D22+D26 D80+D89 D100+D105 D110+D115 D130+D133	METAL Ø 20	<b>€ 1.280,00</b>

Optional cushions available on request see page 344  
Disponibili a richiesta i cuscini accessori si veda a p. 344

Optional protective covers available on request see page 346  
Disponibili a richiesta le coperture protettive accessorie si veda a p. 346

## FINISHES / Finiture



For fabrics see page 367  
Per i tessuti si veda a p. 367

## TECHNICAL DETAILS / Dettagli tecnici

### DN001



### DN002

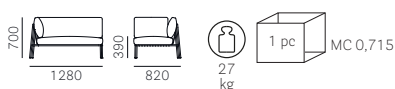

### DN003



### DN004

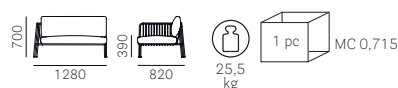

### DN005



## Nym 2830



SEAT Sedile	BACK Schienale	FRAME Telaio	ASH Frassino	ASH STAINED ON SAMPLE Frassino tinto campione
FR-N1-GC- BI-AN	FR-N1-GC- BI-AN	FR-N1-GC- BI-AN	<b>€ 395,00</b>	
TC	TC	TC		<b>€ 418,00</b>

FINISHES / Finiture

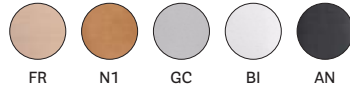

PACKING / Imballo



TECHNICAL DETAILS / Dettagli tecnici

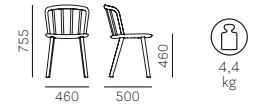

SAFETY, STRENGTH and DURABILITY TESTS  
Prove di sicurezza, resistenza e durata  
EN 1728:2012+AC2013  
EN 16139:2013 level 2

## Nym 2830



SEAT Sedile	BACK Schienale	FRAME Telaio	ASH Frassino
BL2 AZ1 VE2 VE1 RB RA MO MC	BL2 AZ1 VE2 VE1 RB RA MO MC	BL2 AZ1 VE2 VE1 RB RA MO MC	<b>€ 407,00</b> Lacquered with visible grains Laccato a poro aperto

FINISHES / Finiture



PACKING / Imballo



TECHNICAL DETAILS / Dettagli tecnici

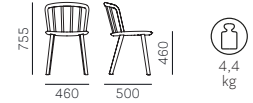

SAFETY, STRENGTH and DURABILITY TESTS  
Prove di sicurezza, resistenza e durata  
EN 1728:2012+AC2013  
EN 16139:2013 level 2

## Nym 2830R



SEAT Sedile	BACK Schienale	FRAME Telaio	ASH Frassino	ASH STAINED ON SAMPLE Frassino tinto campione
FR-N1-GC- BI-AN	FR-N1-GC- BI-AN	FR-N1-GC- BI-AN	<b>€ 440,00</b>	
TC	TC	TC		<b>€ 463,00</b>

Reinforcing frame made of steel rod Ø10mm, black powder coated, for intensive use  
Telaio di rinforzo in tondino Ø10mm, verniciato nero, per uso intensivo

FINISHES / Finiture



PACKING / Imballo



TECHNICAL DETAILS / Dettagli tecnici

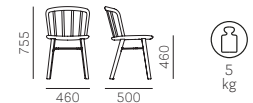

SAFETY, STRENGTH and DURABILITY TESTS  
Prove di sicurezza, resistenza e durata  
EN 1728:2012+AC2013  
EN 16139:2013 level 2



# Nym 2830R



SEAT Sedile	BACK Schienale	FRAME Telaio	ASH Frassino
BL2	BL2	BL2	<p><b>€ 452,00</b> Lacquered with visible grains Laccato a poro aperto</p>
AZ1	AZ1	AZ1	
VE2	VE2	VE2	
VE1	VE1	VE1	
RB	RB	RB	
RA	RA	RA	
MO	MO	MO	
MC	MC	MC	

Reinforcing frame made of steel rod Ø10mm, black powder coated, for intensive use  
Telaio di rinforzo in tondino Ø10mm, verniciato nero, per uso intensivo

**FINISHES / Finiture**



**PACKING / Imballo**



**TECHNICAL DETAILS / Dettagli tecnici**

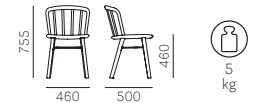

**SAFETY, STRENGTH and DURABILITY TESTS**  
Prove di sicurezza, resistenza e durata  
EN 1728:2012+AC2013  
EN 16139:2013 level 2

# Nym 2831



SEAT Sedile	BACK Schienale	FRAME Telaio	ASH Frassino	ASH STAINED ON SAMPLE Frassino tinto campione
A			<b>€ 461,00</b>	<b>€ 485,00</b>
C*			<b>€ 473,00</b>	<b>€ 496,00</b>
D40÷D44			<b>€ 487,00</b>	<b>€ 510,00</b>
E			<b>€ 509,00</b>	<b>€ 533,00</b>
G	FR-N1-GC- BI-AN	FR-N1-GC- BI-AN	<b>€ 509,00</b>	<b>€ 533,00</b>
H*			<b>€ 477,00</b>	<b>€ 501,00</b>
N	TC	TC	<b>€ 518,00</b>	<b>€ 542,00</b>
P*			<b>€ 522,00</b>	<b>€ 546,00</b>
TC**			<b>€ 461,00</b>	<b>€ 485,00</b>
CL**			<b>€ 467,00</b>	<b>€ 491,00</b>

\*\*TC/CL = Minimum order 10 pcs each fabric colour  
TC/CL = Ordine minimo 10 pz per colore/tessuto

\*Excluding / Escluso C36+C39, H140+H143, PBS-PCO-PMS-PVE

**FINISHES / Finiture**



For fabrics see page 367  
Per i tessuti si veda a p. 367

**PACKING / Imballo**



**FABRIC REQUIRED / Fabbisogno tessuto**  
1 pc: Lin Mtrs 0,28 (h 1,40) fabric/tessuto

**TECHNICAL DETAILS / Dettagli tecnici**

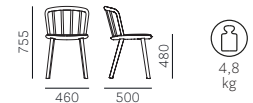

**SAFETY, STRENGTH and DURABILITY TESTS**  
Prove di sicurezza, resistenza e durata  
EN 1728:2012+AC2013  
EN 16139:2013 level 2

# Nym 2831R



SEAT Sedile	BACK Schienale	FRAME Telaio	ASH Frassino	ASH STAINED ON SAMPLE Frassino tinto campione
A			<b>€ 506,00</b>	<b>€ 529,00</b>
C*			<b>€ 517,00</b>	<b>€ 541,00</b>
D40÷D44			<b>€ 532,00</b>	<b>€ 555,00</b>
E			<b>€ 554,00</b>	<b>€ 577,00</b>
G	FR-N1-GC- BI-AN	FR-N1-GC- BI-AN	<b>€ 554,00</b>	<b>€ 577,00</b>
H*			<b>€ 522,00</b>	<b>€ 546,00</b>
N	TC	TC	<b>€ 563,00</b>	<b>€ 587,00</b>
P*			<b>€ 567,00</b>	<b>€ 591,00</b>
TC**			<b>€ 506,00</b>	<b>€ 529,00</b>
CL**			<b>€ 511,00</b>	<b>€ 535,00</b>

\*\*TC/CL = Minimum order 10 pcs each fabric colour  
TC/CL = Ordine minimo 10 pz per colore/tessuto

Reinforcing frame made of steel rod Ø10mm, black powder coated, for intensive use  
Telaio di rinforzo in tondino Ø10mm, verniciato nero, per uso intensivo

\*Excluding / Escluso C36+C39, H140+H143, PBS-PCO-PMS-PVE

**FINISHES / Finiture**



For fabrics see page 367  
Per i tessuti si veda a p. 367

**PACKING / Imballo**



**FABRIC REQUIRED / Fabbisogno tessuto**  
1 pc: Lin Mtrs 0,28 (h 1,40) fabric/tessuto

**TECHNICAL DETAILS / Dettagli tecnici**



**SAFETY, STRENGTH and DURABILITY TESTS**  
Prove di sicurezza, resistenza e durata  
EN 1728:2012+AC2013  
EN 16139:2013 level 2

## Nym 2832

SOFT



SEAT Sedile	BACK Schienale	FRAME Telaio	ASH Frassino	ASH STAINED ON SAMPLE Frassino tinto campione
C*	C*		<b>€ 490,00</b>	<b>€ 512,00</b>
D40÷D44 D120÷D123	D40÷D44 D120÷D123		<b>€ 520,00</b>	<b>€ 542,00</b>
E	E	FR-N1-GC- BI-AN	<b>€ 605,00</b>	<b>€ 627,00</b>
G	G	TC	<b>€ 570,00</b>	<b>€ 592,00</b>
H	H		<b>€ 505,00</b>	<b>€ 527,00</b>
TC**	TC**		<b>€ 465,00</b>	<b>€ 512,00</b>

\*\*TC = Minimum order 10 pcs each fabric colour. Feasibility to be approved  
TC = Ordine minimo 10 pz per colore/tessuto. Fattibilità da valutare

\*Excluding / Escluso C36÷C39

For fabrics see page 367  
Per i tessuti si veda a p. 367

PACKING / Imballo



FABRIC REQUIRED / Fabbisogno tessuto  
1pc: Lin Mtrs 1,00 (h 1,40)

Minimum order q.ty: 20 pcs  
Ordine minimo: 20pz

FINISHES / Finiture



TECHNICAL DETAILS / Dettagli tecnici



SAFETY, STRENGTH and DURABILITY TESTS  
Prove di sicurezza, resistenza e durata  
EN 1728:2012+AC2013  
EN 16139:2013 level 2



## Nym 2840



SEAT Sedile	BACK Schienale	FRAME Telaio	ASH Frassino	ASH STAINED ON SAMPLE Frassino tinto campione
FR-N1-GC- BI-AN	FR-N1-GC- BI-AN	FR-N1-GC- BI-AN	<b>€ 538,00</b>	
TC	TC	TC		<b>€ 561,00</b>

FINISHES / Finiture



PACKING / Imballo



FABRIC REQUIRED / Fabbisogno tessuto  
1pc: Lin Mtrs 1,00 (h 1,40)

TECHNICAL DETAILS / Dettagli tecnici

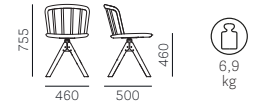

## Nym 2840



SEAT Sedile	BACK Schienale	FRAME Telaio	ASH Frassino
BL2	BL2	BL2	<b>€ 549,00</b> Lacquered with visible grains Laccato a poro aperto
AZ1	AZ1	AZ1	
VE2	VE2	VE2	
VE1	VE1	VE1	
RB	RB	RB	
RA	RA	RA	
MO	MO	MO	
MC	MC	MC	

FINISHES / Finiture



PACKING / Imballo



FABRIC REQUIRED / Fabbisogno tessuto  
1pc: Lin Mtrs 1,00 (h 1,40)

TECHNICAL DETAILS / Dettagli tecnici

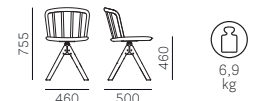

PRODUCT CERTIFIED  
FOR LOW CHEMICAL  
EMISSIONS:  
UL.COM/GG  
UL 2818



PRODUCT CERTIFIED  
FOR LOW CHEMICAL  
EMISSIONS:  
UL.COM/GG  
UL 2818

## Nym 2841



SEAT Sedile	BACK Schienale	FRAME Telaio	ASH Frassino	ASH STAINED ON SAMPLE Frassino tinto campione
A			€ 603,00	€ 627,00
C*			€ 615,00	€ 639,00
D40+D44			€ 629,00	€ 653,00
E	FR-N1-GC-	FR-N1-GC-	€ 652,00	€ 675,00
G	BI-AN	BI-AN	€ 652,00	€ 675,00
H*	TC	TC	€ 620,00	€ 644,00
N			€ 661,00	€ 685,00
P*			€ 664,00	€ 688,00
TC**			€ 603,00	€ 627,00
CL**			€ 609,00	€ 633,00

\*\*TC/CL = Minimum order 10 pcs each fabric colour  
TC/CL = Ordine minimo 10 pz per colore/tessuto

\*Excluding / Escluso C36+C39, H140+H143, PBS-PCO-PMS-PVE

### FINISHES / Finiture

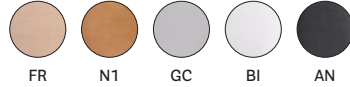

For fabrics see page 367  
Per i tessuti si veda a p. 367

### PACKING / Imballo



FABRIC REQUIRED / Fabbisogno tessuto  
1pc: Lin Mtrs 0,28 (h 1,40) fabric/tessuto

### TECHNICAL DETAILS / Dettagli tecnici

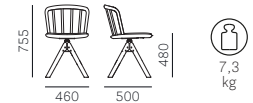

## Nym 2842

SOFT



SEAT Sedile	BACK Schienale	FRAME Telaio	ASH Frassino	ASH STAINED ON SAMPLE Frassino tinto campione
C*	C*		€ 560,00	€ 582,00
D40+D44	D40+D44		€ 593,00	€ 615,00
D120+D123	D120+D123	FR-N1-GC-	€ 681,00	€ 703,00
E	E	BI-AN	€ 644,00	€ 666,00
G	G	TC	€ 571,00	€ 593,00
H	H		€ 532,00	€ 554,00
TC**	TC**			

\*\*TC = Minimum order 10 pcs each fabric colour. Feasibility to be approved  
TC = Ordine minimo 10 pz per colore/tessuto. Fattibilità da valutare

\*Excluding / Escluso C36+C39

### FINISHES / Finiture

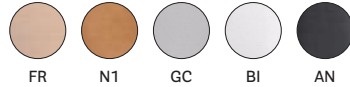

For fabrics see page 367  
Per i tessuti si veda a p. 367

### PACKING / Imballo



FABRIC REQUIRED / Fabbisogno tessuto  
1pc: Lin Mtrs 1,00 (h 1,40)

### TECHNICAL DETAILS / Dettagli tecnici



## Nym 2850



SEAT Sedile	BACK Schienale	FRAME Telaio	ASH Frassino	ASH STAINED ON SAMPLE Frassino tinto campione
FR-N1-GC-	FR-N1-GC-		POWDER COATED	POWDER COATED
BI-AN	BI-AN		Verniciato	Verniciato
			€ 356,00	
TC	TC	Ø 11		€ 380,00

### FINISHES / Finiture



### PACKING / Imballo



### TECHNICAL DETAILS / Dettagli tecnici

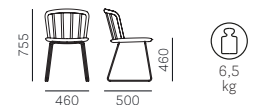

For colours and finishes see at page 362  
Per colori e finiture vedere da pagina 362





## Nym 2851



SEAT Sedile	BACK Schienale	FRAME Telaio	ASH Frassino	ASH STAINED ON SAMPLE Frassino tinto campione
			POWDER COATED Verniciato	POWDER COATED Verniciato
A			€ 422,00	€ 446,00
C*			€ 434,00	€ 457,00
D40÷D44			€ 448,00	€ 471,00
E			€ 470,00	€ 494,00
G	FR-N1-GC-	Ø 11	€ 470,00	€ 494,00
H*	BI-AN		€ 439,00	€ 462,00
N	TC		€ 480,00	€ 503,00
P*			€ 483,00	€ 507,00
TC**			€ 422,00	€ 446,00
CL**			€ 428,00	€ 452,00

\*\*TC/CL = Minimum order 10 pcs each fabric colour  
TC/CL = Ordine minimo 10 pz per colore/tessuto

\*Excluding / Escluso C36+C39, H140+H143, PBS-PCO-PMS-PVE

### FINISHES / Finiture

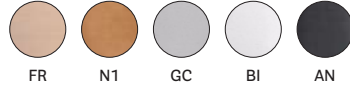

For fabrics see page 367  
Per i tessuti si veda a p. 367

### PACKING / Imballo



FABRIC REQUIRED / Fabbisogno tessuto  
1pc: Lin Mtrs 0,28 (h 1,40) fabric/tessuto

### TECHNICAL DETAILS / Dettagli tecnici

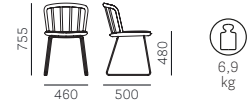

## Nym 2852

SOFT



SEAT Sedile	BACK Schienale	FRAME Telaio	POWDER COATED Verniciato
C*	C*		€ 420,00
D40÷D44 D120÷D123	D40÷D44 D120÷D123		€ 450,00
E	E	Ø 11	€ 535,00
G	G		€ 500,00
H	H		€ 435,00
TC**	TC**		€ 395,00

\*\*TC = Minimum order 10 pcs each fabric colour. Feasibility to be approved  
TC = Ordine minimo 10 pz per colore/tessuto. Fattibilità da valutare

\*Excluding / Escluso C36+C39

For fabrics see page 367  
Per i tessuti si veda a p. 367

### PACKING / Imballo



FABRIC REQUIRED / Fabbisogno tessuto  
1pc: Lin Mtrs 1,00 (h 1,40)

### TECHNICAL DETAILS / Dettagli tecnici



## Nym 2882

SOFT



SEAT Sedile	BACK Schienale	FRAME Telaio	POWDER COATED Verniciato
C*	C*		€ 420,00
D40÷D44 D120÷D123	D40÷D44 D120÷D123		€ 450,00
E	E	Ø 16	€ 535,00
G	G		€ 500,00
H	H		€ 435,00
TC**	TC**		€ 395,00

\*\*TC = Minimum order 10 pcs each fabric colour. Feasibility to be approved  
TC = Ordine minimo 10 pz per colore/tessuto. Fattibilità da valutare

\*Excluding / Escluso C36+C39

For fabrics see page 367  
Per i tessuti si veda a p. 367

### PACKING / Imballo



FABRIC REQUIRED / Fabbisogno tessuto  
1pc: Lin Mtrs 1,00 (h 1,40)

### TECHNICAL DETAILS / Dettagli tecnici



For colours and finishes see at page 362  
Per colori e finiture vedere da pagina 362

## Nym 2835



SEAT Sedile	BACK Schienale	FRAME Telaio	ASH Frassino	ASH STAINED ON SAMPLE Frassino tinto campione
FR-N1-GC-BI-AN	FR-N1-GC-BI-AN	FR-N1-GC-BI-AN	<b>€ 430,00</b>	
TC	TC	TC		<b>€ 453,00</b>

FINISHES / Finiture

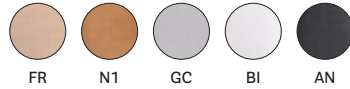

PACKING / Imballo



TECHNICAL DETAILS / Dettagli tecnici



SAFETY, STRENGTH and DURABILITY TESTS  
 Prove di sicurezza, resistenza e durata  
 EN 1728:2012+AC2013  
 EN 16139:2013 level 2



## Nym 2835



SEAT Sedile	BACK Schienale	FRAME Telaio	ASH Frassino
BL2 AZ1 VE2 VE1 RB RA MO MC	BL2 AZ1 VE2 VE1 RB RA MO MC	BL2 AZ1 VE2 VE1 RB RA MO MC	<b>€ 441,00</b> Lacquered with visible grains Laccato a poro aperto

FINISHES / Finiture



PACKING / Imballo



TECHNICAL DETAILS / Dettagli tecnici



SAFETY, STRENGTH and DURABILITY TESTS  
 Prove di sicurezza, resistenza e durata  
 EN 1728:2012+AC2013  
 EN 16139:2013 level 2



## Nym 2835R



SEAT Sedile	BACK Schienale	FRAME Telaio	ASH Frassino	ASH STAINED ON SAMPLE Frassino tinto campione
FR-N1-GC-BI-AN	FR-N1-GC-BI-AN	FR-N1-GC-BI-AN	<b>€ 474,00</b>	
TC	TC	TC		<b>€ 498,00</b>

Reinforcing frame made of steel rod Ø10mm, black powder coated, for intensive use  
 Telaio di rinforzo in tondino Ø10mm, verniciato nero, per uso intensivo

FINISHES / Finiture

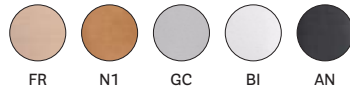

PACKING / Imballo



TECHNICAL DETAILS / Dettagli tecnici



SAFETY, STRENGTH and DURABILITY TESTS  
 Prove di sicurezza, resistenza e durata  
 EN 1728:2012+AC2013  
 EN 16139:2013 level 2



## Nym 2835R



SEAT Sedile	BACK Schienale	FRAME Telaio	ASH Frassino
BL2	BL2	BL2	<p><b>€ 486,00</b> Lacquered with visible grains Laccato a poro aperto</p>
AZ1	AZ1	AZ1	
VE2	VE2	VE2	
VE1	VE1	VE1	
RB	RB	RB	
RA	RA	RA	
MO	MO	MO	
MC	MC	MC	

Reinforcing frame made of steel rod Ø10mm, black powder coated, for intensive use  
Telaio di rinforzo in tondino Ø10mm, verniciato nero, per uso intensivo

**FINISHES / Finiture**



**PACKING / Imballo**



**TECHNICAL DETAILS / Dettagli tecnici**

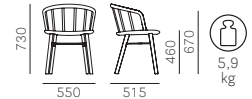

**SAFETY, STRENGTH and DURABILITY TESTS**  
Prove di sicurezza, resistenza e durata  
EN 1728:2012+AC2013  
EN 16139:2013 level 2

## Nym 2836



SEAT Sedile	BACK Schienale	FRAME Telaio	ASH Frassino	ASH STAINED ON SAMPLE Frassino tinto campione
A			<b>€ 500,00</b>	<b>€ 523,00</b>
C*			<b>€ 511,00</b>	<b>€ 535,00</b>
D40÷D44			<b>€ 526,00</b>	<b>€ 549,00</b>
E			<b>€ 548,00</b>	<b>€ 571,00</b>
G	FR-N1-GC- BI-AN	FR-N1-GC- BI-AN	<b>€ 548,00</b>	<b>€ 571,00</b>
H*			<b>€ 516,00</b>	<b>€ 540,00</b>
N	TC	TC	<b>€ 557,00</b>	<b>€ 581,00</b>
P*			<b>€ 561,00</b>	<b>€ 585,00</b>
TC**			<b>€ 500,00</b>	<b>€ 523,00</b>
CL**			<b>€ 506,00</b>	<b>€ 529,00</b>

\*\*TC/CL = Minimum order 10 pcs each fabric colour  
TC/CL = Ordine minimo 10 pz per colore/tessuto

\*Excluding / Escluso C36+C39, H140+H143, PBS-PCO-PMS-PVE

**FINISHES / Finiture**

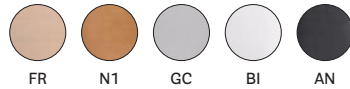

For fabrics see page 367  
Per i tessuti si veda a p. 367

**PACKING / Imballo**



**TECHNICAL DETAILS / Dettagli tecnici**



**SAFETY, STRENGTH and DURABILITY TESTS**  
Prove di sicurezza, resistenza e durata  
EN 1728:2012+AC2013  
EN 16139:2013 level 2

## Nym 2836R



SEAT Sedile	BACK Schienale	FRAME Telaio	ASH Frassino	ASH STAINED ON SAMPLE Frassino tinto campione
A			<b>€ 545,00</b>	<b>€ 568,00</b>
C*			<b>€ 556,00</b>	<b>€ 580,00</b>
D40÷D44			<b>€ 570,00</b>	<b>€ 594,00</b>
E			<b>€ 593,00</b>	<b>€ 616,00</b>
G	FR-N1-GC- BI-AN	FR-N1-GC- BI-AN	<b>€ 593,00</b>	<b>€ 616,00</b>
H*			<b>€ 561,00</b>	<b>€ 585,00</b>
N	TC	TC	<b>€ 602,00</b>	<b>€ 626,00</b>
P*			<b>€ 606,00</b>	<b>€ 629,00</b>
TC**			<b>€ 545,00</b>	<b>€ 568,00</b>
CL**			<b>€ 550,00</b>	<b>€ 574,00</b>

\*\*TC/CL = Minimum order 10 pcs each fabric colour  
TC/CL = Ordine minimo 10 pz per colore/tessuto

Reinforcing frame made of steel rod Ø10mm, black powder coated, for intensive use  
Telaio di rinforzo in tondino Ø10mm, verniciato nero, per uso intensivo

\*Excluding / Escluso C36+C39, H140+H143, PBS-PCO-PMS-PVE

**FINISHES / Finiture**



For fabrics see page 367  
Per i tessuti si veda a p. 367

**PACKING / Imballo**



**TECHNICAL DETAILS / Dettagli tecnici**



**SAFETY, STRENGTH and DURABILITY TESTS**  
Prove di sicurezza, resistenza e durata  
EN 1728:2012+AC2013  
EN 16139:2013 level 2

## Nym 2837

SOFT



SEAT Sedile	BACK Schienale	FRAME Telaio	ASH Frassino	ASH STAINED ON SAMPLE Frassino tinto campione
C*	C*		<b>€ 550,00</b>	<b>€ 572,00</b>
D40÷D44 D120÷D123	D40÷D44 D120÷D123		<b>€ 585,00</b>	<b>€ 607,00</b>
E	E	FR-N1-GC- BI-AN	<b>€ 685,00</b>	<b>€ 707,00</b>
G	G	TC	<b>€ 645,00</b>	<b>€ 667,00</b>
H	H		<b>€ 565,00</b>	<b>€ 587,00</b>
TC**	TC**		<b>€ 520,00</b>	<b>€ 542,00</b>

\*\*TC = Minimum order 10 pcs each fabric colour. Feasibility to be approved  
TC = Ordine minimo 10 pz per colore/tessuto. Fattibilità da valutare

\*Excluding / Escluso C36+C39

For fabrics see page 367  
Per i tessuti si veda a p. 367

PACKING / Imballo



FABRIC REQUIRED / Fabbisogno tessuto  
1pc: Lin Mtrs 1,20 (h 1,40)

TECHNICAL DETAILS / Dettagli tecnici

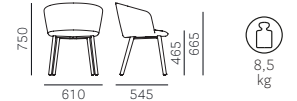

SAFETY, STRENGTH and DURABILITY TESTS  
Prove di sicurezza, resistenza e durata  
EN 1728:2012+AC2013  
EN 16139:2013 level 2

FINISHES / Finiture



## Nym 2845



SEAT Sedile	BACK Schienale	FRAME Telaio	ASH Frassino	ASH STAINED ON SAMPLE Frassino tinto campione
FR-N1-GC- BI-AN	FR-N1-GC- BI-AN	FR-N1-GC- BI-AN	<b>€ 576,00</b>	
TC	TC	TC		<b>€ 600,00</b>

Minimum order q.ty: 20 pcs  
Ordine minimo: 20pz

FINISHES / Finiture

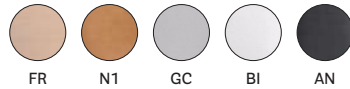

PACKING / Imballo



TECHNICAL DETAILS / Dettagli tecnici



## Nym 2845



SEAT Sedile	BACK Schienale	FRAME Telaio	ASH Frassino
BL2 AZ1 VE2 VE1 RB RA MO MC	BL2 AZ1 VE2 VE1 RB RA MO MC	BL2 AZ1 VE2 VE1 RB RA MO MC	<b>€ 588,00</b> Lacquered with visible grains Laccato a poro aperto

FINISHES / Finiture

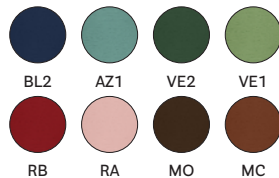

PACKING / Imballo



TECHNICAL DETAILS / Dettagli tecnici



## Nym 2846



SEAT Sedile	BACK Schienale	FRAME Telaio	ASH Frassino	ASH STAINED ON SAMPLE Frassino tinto campione
A			€ 642,00	€ 666,00
C*			€ 654,00	€ 677,00
D40+D44			€ 668,00	€ 692,00
E	FR-N1-GC-	FR-N1-GC-	€ 691,00	€ 714,00
G	BI-AN	BI-AN	€ 691,00	€ 714,00
H*	TC	TC	€ 659,00	€ 682,00
N			€ 700,00	€ 723,00
P*			€ 703,00	€ 727,00
TC**			€ 642,00	€ 666,00
CL**			€ 648,00	€ 671,00

\*\*TC/CL = Minimum order 10 pcs each fabric colour  
TC/CL = Ordine minimo 10 pz per colore/tessuto

\*Excluding / Escluso C36+C39, H140+H143, PBS-PCO-PMS-PVE

### FINISHES / Finiture

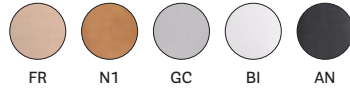

For fabrics see page 367  
Per i tessuti si veda a p. 367

### PACKING / Imballo



FABRIC REQUIRED / Fabbisogno tessuto  
1pc: Lin Mtrs 0,28 (h 1,40) fabric/tessuto

### TECHNICAL DETAILS / Dettagli tecnici



## Nym 2847

SOFT



SEAT Sedile	BACK Schienale	FRAME Telaio	ASH Frassino	ASH STAINED ON SAMPLE Frassino tinto campione
C*	C*		€ 613,00	€ 635,00
D40+D44	D40+D44		€ 653,00	€ 675,00
D120+D123	D120+D123	FR-N1-GC-	€ 759,00	€ 781,00
E	E	BI-AN	€ 713,00	€ 735,00
G	G	TC	€ 627,00	€ 649,00
H	H		€ 580,00	€ 602,00
TC**	TC**			

\*\*TC = Minimum order 10 pcs each fabric colour. Feasibility to be approved  
TC = Ordine minimo 10 pz per colore/tessuto. Fattibilità da valutare

\*Excluding / Escluso C36+C39

### FINISHES / Finiture



For fabrics see page 367  
Per i tessuti si veda a p. 367

### PACKING / Imballo



FABRIC REQUIRED / Fabbisogno tessuto  
1pc: Lin Mtrs 1,20 (h 1,40)

### TECHNICAL DETAILS / Dettagli tecnici



## Nym 2855



SEAT Sedile	BACK Schienale	FRAME Telaio	ASH Frassino	ASH STAINED ON SAMPLE Frassino tinto campione
FR-N1-GC-	FR-N1-GC-		POWDER COATED Verniciato	POWDER COATED Verniciato
BI-AN	BI-AN		€ 395,00	
TC	TC	Ø 11		€ 418,00

### FINISHES / Finiture



### PACKING / Imballo



### TECHNICAL DETAILS / Dettagli tecnici

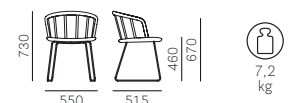

For colours and finishes see at page 362  
Per colori e finiture vedere da pagina 362



## Nym 2856



SEAT Sedile	BACK Schienale	FRAME Telaio	ASH Frassino	ASH STAINED ON SAMPLE Frassino tinto campione
			POWDER COATED Verniciato	POWDER COATED Verniciato
A	FR-N1-GC- BI-AN TC	Ø 11	€ 461,00	€ 485,00
C*			€ 473,00	€ 496,00
D40÷D44			€ 487,00	€ 510,00
E			€ 509,00	€ 533,00
G			€ 509,00	€ 533,00
H*			€ 477,00	€ 501,00
N			€ 518,00	€ 542,00
P**			€ 522,00	€ 546,00
TC**			€ 461,00	€ 485,00
CL**			€ 467,00	€ 491,00

\*\*TC/CL = Minimum order 10 pcs each fabric colour  
TC/CL = Ordine minimo 10 pz per colore/tessuto

\*Excluding / Escluso C36+C39, H140+H143, PBS-PCO-PMS-PVE

### FINISHES / Finiture

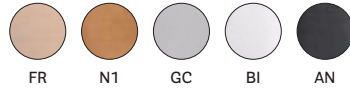

For fabrics see page 367  
Per i tessuti si veda a p. 367

### PACKING / Imballo



**FABRIC REQUIRED / Fabbisogno tessuto**  
1pc: Lin Mtrs 0,28 (h 1,40) fabric/tessuto

### TECHNICAL DETAILS / Dettagli tecnici

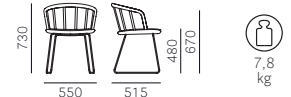

## Nym 2857

SOFT



SEAT Sedile	BACK Schienale	FRAME Telaio	POWDER COATED Verniciato
C*	C*	Ø 11	€ 480,00
D40÷D44 D120÷D123	D40÷D44 D120÷D123		€ 515,00
E	E		€ 615,00
G	G		€ 575,00
H	H		€ 495,00
TC**	TC**		€ 450,00

\*\*TC = Minimum order 10 pcs each fabric colour. Feasibility to be approved  
TC = Ordine minimo 10 pz per colore/tessuto. Fattibilità da valutare

\*Excluding / Escluso C36+C39

For fabrics see page 367  
Per i tessuti si veda a p. 367

### PACKING / Imballo



**FABRIC REQUIRED / Fabbisogno tessuto**  
1pc: Lin Mtrs 1,20 (h 1,40)

### TECHNICAL DETAILS / Dettagli tecnici

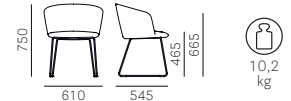

## Nym 2887

SOFT



SEAT Sedile	BACK Schienale	FRAME Telaio	POWDER COATED Verniciato
C*	C*	Ø 16	€ 480,00
D40÷D44 D120÷D123	D40÷D44 D120÷D123		€ 515,00
E	E		€ 615,00
G	G		€ 575,00
H	H		€ 495,00
TC**	TC**		€ 450,00

\*\*TC = Minimum order 10 pcs each fabric colour. Feasibility to be approved  
TC = Ordine minimo 10 pz per colore/tessuto. Fattibilità da valutare

\*Excluding / Escluso C36+C39

For fabrics see page 367  
Per i tessuti si veda a p. 367

### PACKING / Imballo



**FABRIC REQUIRED / Fabbisogno tessuto**  
1pc: Lin Mtrs 1,20 (h 1,40)

### TECHNICAL DETAILS / Dettagli tecnici



For colours and finishes see at page 362  
Per colori e finiture vedere da pagina 362

# Nym 2877

SOFT



SEAT Sedile	BACK Schienale	FRAME Telaio	WHITE/BLACK POWDER COATED Verniciato bianco/nero	POLISHED ALUMINIUM Alluminio lucidato
C*	C*	Ø 750	€ 530,00	€ 585,00
D40+D44 D120+D123	D40+D44 D120+D123		€ 569,00	€ 624,00
E	E		€ 676,00	€ 731,00
G	G		€ 630,00	€ 685,00
H	H		€ 544,00	€ 599,00
TC**	TC**		€ 497,00	€ 552,00

\*\*TC = Minimum order 10 pcs each fabric colour. Feasibility to be approved  
TC = Ordine minimo 10 pz per colore/tessuto. Fattibilità da valutare

\*Excluding / Escluso C36+C39

For fabrics see page 367  
Per i tessuti si veda a p. 367

PACKING / Imballo



FABRIC REQUIRED / Fabbisogno tessuto  
1pc: Lin Mtrs 1,20 (h 1,40)

TECHNICAL DETAILS / Dettagli tecnici



# Nym 2838



SEAT Sedile	BACK Schienale	FRAME Telaio	ASH Frassino	ASH STAINED ON SAMPLE Frassino tinto campione
FR-N1-GC- BI-AN	FR-N1-GC- BI-AN	H655	BRUSHED S/STEEL Inox satinato	BRUSHED S/STEEL Inox satinato
TC	TC		€ 467,00	€ 491,00

Minimum order q.ty: 20 pcs  
Ordine minimo: 20pz

FINISHES / Finiture



PACKING / Imballo



TECHNICAL DETAILS / Dettagli tecnici



SAFETY, STRENGTH and DURABILITY TESTS  
Prove di sicurezza, resistenza e durata  
EN 1728:2012+AC2013  
EN 16139:2013 level 2

# Nym 2838



SEAT Sedile	BACK Schienale	FRAME Telaio	ASH Frassino
BL2 AZ1 VE2 VE1 RB RA MO MC	BL2 AZ1 VE2 VE1 RB RA MO MC	H655	BRUSHED S/STEEL Inox satinato
			€ 479,00 Lacquered with visible grains Laccato a poro aperto

FINISHES / Finiture

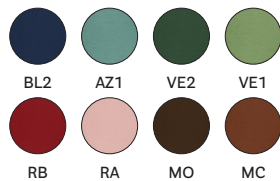

PACKING / Imballo



TECHNICAL DETAILS / Dettagli tecnici



SAFETY, STRENGTH and DURABILITY TESTS  
Prove di sicurezza, resistenza e durata  
EN 1728:2012+AC2013  
EN 16139:2013 level 2



## Nym 2838/A



SEAT Sedile	BACK Schienale	FRAME Telaio	ASH Frassino	ASH STAINED ON SAMPLE Frassino tinto campione
			BRUSHED S/STEEL Inox satinato	BRUSHED S/STEEL Inox satinato
A	FR-N1-GC- BI-AN  TC	H675	€ 533,00	€ 556,00
C*			€ 545,00	€ 568,00
D40÷D44			€ 559,00	€ 582,00
E			€ 581,00	€ 605,00
G			€ 581,00	€ 605,00
H*			€ 549,00	€ 573,00
N			€ 591,00	€ 614,00
P*			€ 594,00	€ 617,00
TC**			€ 533,00	€ 556,00
CL**			€ 539,00	€ 562,00

\*\*TC/CL = Minimum order 10 pcs each fabric colour  
TC/CL = Ordine minimo 10 pz per colore/tessuto

\*Excluding / Escluso C36+C39, H140+H143, PBS-PCO-PMS-PVE

### FINISHES / Finiture



For fabrics see page 367  
Per i tessuti si veda a p. 367

### PACKING / Imballo



FABRIC REQUIRED / Fabbisogno tessuto  
1pc: Lin Mtrs 0,28 (h 1,40) fabric/tessuto

### TECHNICAL DETAILS / Dettagli tecnici



SAFETY, STRENGTH and DURABILITY TESTS  
Prove di sicurezza, resistenza e durata  
EN 1728:2012+AC2013  
EN 16139:2013 level 2



## Nym 2839



SEAT Sedile	BACK Schienale	FRAME Telaio	ASH Frassino	ASH STAINED ON SAMPLE Frassino tinto campione
			BRUSHED S/STEEL Inox satinato	BRUSHED S/STEEL Inox satinato
FR-N1-GC- BI-AN	FR-N1-GC- BI-AN	H755	€ 471,00	
TC	TC			€ 495,00

### FINISHES / Finiture

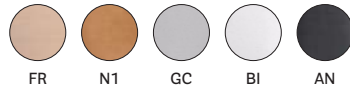

### PACKING / Imballo



### TECHNICAL DETAILS / Dettagli tecnici



SAFETY, STRENGTH and DURABILITY TESTS  
Prove di sicurezza, resistenza e durata  
EN 1728:2012+AC2013  
EN 16139:2013 level 2

## Nym 2839



SEAT Sedile	BACK Schienale	FRAME Telaio	ASH Frassino
			BRUSHED S/STEEL Inox satinato
BL2 AZ1 VE2 VE1 RB RA MO MC	BL2 AZ1 VE2 VE1 RB RA MO MC	H755	€ 483,00 Lacquered with visible grains Laccato a poro aperto

### FINISHES / Finiture



### PACKING / Imballo



### TECHNICAL DETAILS / Dettagli tecnici



SAFETY, STRENGTH and DURABILITY TESTS  
Prove di sicurezza, resistenza e durata  
EN 1728:2012+AC2013  
EN 16139:2013 level 2



PRODUCT CERTIFIED  
FOR LOW CHEMICAL  
EMISSIONS:  
UL.COM/CGG  
UL 2818



PRODUCT CERTIFIED  
FOR LOW CHEMICAL  
EMISSIONS:  
UL.COM/CGG  
UL 2818



## Nym 2839/A



SEAT Sedile	BACK Schienale	FRAME Telaio	ASH Frassino	ASH STAINED ON SAMPLE Frassino tinto campione
			BRUSHED S/STEEL Inox satinato	BRUSHED S/STEEL Inox satinato
A	FR-N1-GC- BI-AN  TC	H775	€ 538,00	€ 561,00
C*			€ 549,00	€ 573,00
D40+D44			€ 563,00	€ 587,00
E			€ 586,00	€ 609,00
G			€ 586,00	€ 609,00
H*			€ 554,00	€ 577,00
N			€ 595,00	€ 618,00
P*			€ 599,00	€ 622,00
TC**			€ 538,00	€ 561,00
CL**			€ 544,00	€ 567,00

\*\*TC/CL = Minimum order 10 pcs each fabric colour  
TC/CL = Ordine minimo 10 pz per colore/tessuto

\*Excluding / Escluso C36+C39, H140+H143, PBS-PCO-PMS-PVE

### FINISHES / Finiture

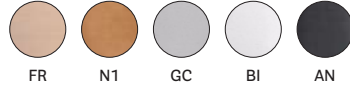

For fabrics see page 367  
Per i tessuti si veda a p. 367

### PACKING / Imballo



FABRIC REQUIRED / Fabbisogno tessuto  
1pc: Lin Mtrs 0,28 (h 1,40) fabric/tessuto

### TECHNICAL DETAILS / Dettagli tecnici



SAFETY, STRENGTH and DURABILITY TESTS  
Prove di sicurezza, resistenza e durata  
EN 1728:2012+AC2013  
EN 16139:2013 level 2



## Nym 2848



SEAT Sedile	BACK Schienale	FRAME Telaio	ASH Frassino	ASH STAINED ON SAMPLE Frassino tinto campione
			BLACK POWDER COATED Verniciato nero	BLACK POWDER COATED Verniciato nero
FR-N1-GC- BI-AN	FR-N1-GC- BI-AN	H650	€ 577,00	
TC	TC			€ 601,00

### FINISHES / Finiture



### PACKING / Imballo



### TECHNICAL DETAILS / Dettagli tecnici



## Nym 2848



SEAT Sedile	BACK Schienale	FRAME Telaio	ASH Frassino
			BLACK POWDER COATED Verniciato nero
BL2 AZ1 VE2 VE1 RB RA MO MC	BL2 AZ1 VE2 VE1 RB RA MO MC	H650	€ 589,00 Lacquered with visible grains Laccato a poro aperto

### FINISHES / Finiture

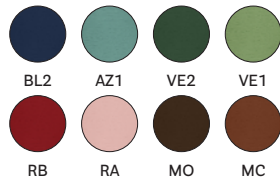

### PACKING / Imballo



### TECHNICAL DETAILS / Dettagli tecnici



PRODUCT CERTIFIED  
FOR LOW CHEMICAL  
EMISSIONS:  
UL.COM/CGG  
UL 2818



PRODUCT CERTIFIED  
FOR LOW CHEMICAL  
EMISSIONS:  
UL.COM/CGG  
UL 2818

## Nym 2848/A



SEAT Sedile	BACK Schienale	FRAME Telaio	ASH Frassino	ASH STAINED ON SAMPLE Frassino tinto campione
			BLACK POWDER COATED Verniciato nero	BLACK POWDER COATED Verniciato nero
A	FR-N1-GC- BI-AN  TC	H670	€ 644,00	€ 667,00
C*			€ 655,00	€ 679,00
D40* D44			€ 669,00	€ 693,00
E			€ 692,00	€ 715,00
G			€ 692,00	€ 715,00
H*			€ 660,00	€ 683,00
N			€ 701,00	€ 724,00
P*			€ 705,00	€ 728,00
TC**			€ 644,00	€ 667,00
CL**			€ 649,00	€ 673,00

\*\*TC/CL = Minimum order 10 pcs each fabric colour  
TC/CL = Ordine minimo 10 pz per colore/tessuto

\*Excluding / Escluso C36+C39, H140+H143, PBS-PCO-PMS-PVE

### FINISHES / Finiture

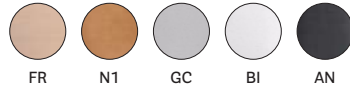

For fabrics see page 367  
Per i tessuti si veda a p. 367

### PACKING / Imballo



FABRIC REQUIRED / Fabbisogno tessuto  
1pc: Lin Mtrs 0,28 (h 1,40) fabric/tessuto

### TECHNICAL DETAILS / Dettagli tecnici



## Nym 2849



SEAT Sedile	BACK Schienale	FRAME Telaio	ASH Frassino	ASH STAINED ON SAMPLE Frassino tinto campione
			BLACK POWDER COATED Verniciato nero	BLACK POWDER COATED Verniciato nero
FR-N1-GC- BI-AN	FR-N1-GC- BI-AN	H750	€ 582,00	
TC	TC			€ 606,00

### FINISHES / Finiture



### PACKING / Imballo



### TECHNICAL DETAILS / Dettagli tecnici



## Nym 2849



SEAT Sedile	BACK Schienale	FRAME Telaio	ASH Frassino
			BLACK POWDER COATED Verniciato nero
BL2 AZ1 VE2 VE1 RB RA MO MC	BL2 AZ1 VE2 VE1 RB RA MO MC	H750	€ 594,00 Lacquered with visible grains Laccato a poro aperto

### FINISHES / Finiture



### PACKING / Imballo



### TECHNICAL DETAILS / Dettagli tecnici



## Nym 2849/A



SEAT Sedile	BACK Schienale	FRAME Telaio	ASH Frassino	ASH STAINED ON SAMPLE Frassino tinto campione
			BLACK POWDER COATED Verniciato nero	BLACK POWDER COATED Verniciato nero
A	FR-N1-GC- BI-AN  TC	H770	€ 648,00	€ 671,00
C*			€ 660,00	€ 683,00
D40÷D44			€ 674,00	€ 698,00
E			€ 697,00	€ 720,00
G			€ 697,00	€ 720,00
H*			€ 664,00	€ 688,00
N			€ 706,00	€ 729,00
P*			€ 709,00	€ 733,00
TC**			€ 648,00	€ 671,00
CL**			€ 654,00	€ 677,00

\*\*TC/CL = Minimum order 10 pcs each fabric colour  
TC/CL = Ordine minimo 10 pz per colore/tessuto

\*Excluding / Escluso C36+C39, H140+H143, PBS-PCO-PMS-PVE

### FINISHES / Finiture



For fabrics see page 367  
Per i tessuti si veda a p. 367

### PACKING / Imballo



FABRIC REQUIRED / Fabbisogno tessuto  
1pc: Lin Mtrs 0,28 (h 1,40) fabric/tessuto

### TECHNICAL DETAILS / Dettagli tecnici



## Nym 2858



SEAT Sedile	BACK Schienale	FRAME Telaio	ASH Frassino	ASH STAINED ON SAMPLE Frassino tinto campione
			POWDER COATED Verniciato	POWDER COATED Verniciato
FR-N1-GC- BI-AN	FR-N1-GC- BI-AN	Ø 11 H650	€ 373,00	
TC	TC			€ 396,00

### FINISHES / Finiture



### PACKING / Imballo



### TECHNICAL DETAILS / Dettagli tecnici

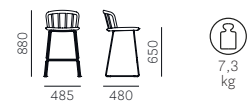

## Nym 2858/A



SEAT Sedile	BACK Schienale	FRAME Telaio	ASH Frassino	ASH STAINED ON SAMPLE Frassino tinto campione
			POWDER COATED Verniciato	POWDER COATED Verniciato
A	FR-N1-GC- BI-AN  TC	Ø 11 H670	€ 439,00	€ 462,00
C*			€ 450,00	€ 474,00
D40÷D44			€ 464,00	€ 488,00
E			€ 487,00	€ 510,00
G			€ 487,00	€ 510,00
H*			€ 455,00	€ 479,00
N			€ 496,00	€ 520,00
P*			€ 500,00	€ 523,00
TC**			€ 439,00	€ 462,00
CL**			€ 445,00	€ 468,00

\*\*TC/CL = Minimum order 10 pcs each fabric colour  
TC/CL = Ordine minimo 10 pz per colore/tessuto

\*Excluding / Escluso C36+C39, H140+H143, PBS-PCO-PMS-PVE

### FINISHES / Finiture



For fabrics see page 367  
Per i tessuti si veda a p. 367

### PACKING / Imballo



FABRIC REQUIRED / Fabbisogno tessuto  
1pc: Lin Mtrs 0,28 (h 1,40) fabric/tessuto

### TECHNICAL DETAILS / Dettagli tecnici



PRODUCT CERTIFIED  
FOR LOW CHEMICAL  
EMISSIONS:  
UL.COM/GG  
UL 2818

For colours and finishes see at page 362  
Per colori e finiture vedere da pagina 362



## Nym 2859



SEAT Sedile	BACK Schienale	FRAME Telaio	ASH Frassino	ASH STAINED ON SAMPLE Frassino tinto campione
			POWDER COATED Verniciato	POWDER COATED Verniciato
FR-N1-GC- BI-AN	FR-N1-GC- BI-AN	Ø 11 H750	<b>€ 377,00</b>	<b>€ 401,00</b>
TC	TC			

FINISHES / Finiture



PACKING / Imballo



TECHNICAL DETAILS / Dettagli tecnici

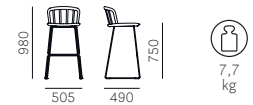

## Nym 2859/A



SEAT Sedile	BACK Schienale	FRAME Telaio	ASH Frassino	ASH STAINED ON SAMPLE Frassino tinto campione
			POWDER COATED Verniciato	POWDER COATED Verniciato
A	FR-N1-GC- BI-AN	Ø 11 H770	<b>€ 443,00</b>	<b>€ 467,00</b>
C*			<b>€ 455,00</b>	<b>€ 479,00</b>
D40÷D44			<b>€ 469,00</b>	<b>€ 493,00</b>
E			<b>€ 492,00</b>	<b>€ 515,00</b>
G			<b>€ 492,00</b>	<b>€ 515,00</b>
H*			<b>€ 460,00</b>	<b>€ 483,00</b>
N			<b>€ 501,00</b>	<b>€ 524,00</b>
P*			<b>€ 504,00</b>	<b>€ 528,00</b>
TC**			<b>€ 443,00</b>	<b>€ 467,00</b>
CL**			<b>€ 449,00</b>	<b>€ 473,00</b>

\*\*TC/CL = Minimum order 10 pcs each fabric colour  
TC/CL = Ordine minimo 10 pz per colore/tessuto

\*Excluding / Escluso C36+C39, H140+H143, PBS-PCO-PMS-PVE

FINISHES / Finiture

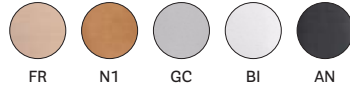

For fabrics see page 367  
Per i tessuti si veda a p. 367

PACKING / Imballo



FABRIC REQUIRED / Fabbisogno tessuto  
1pc: Lin Mtrs 0,28 (h 1,40) fabric/tessuto

TECHNICAL DETAILS / Dettagli tecnici

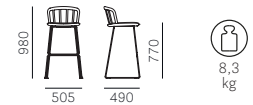

## Osaka 2810



SEAT Sedile	BACK Schienale	FRAME Telaio	ASH Frassino	ASH STAINED ON SAMPLE Frassino tinto campione
FR-N1-GC- BI-AN	FR-N1-GC- BI-AN	FR-N1-GC- BI-AN	<b>€ 267,00</b>	<b>€ 291,00</b>
TC	TC	TC		

### FINISHES / Finiture



### PACKING / Imballo



### TECHNICAL DETAILS / Dettagli tecnici



**SAFETY, STRENGTH and DURABILITY TESTS**  
 Prove di sicurezza, resistenza e durata  
 EN 1728:2012+AC2013  
 EN 16139:2013 level 2

## Osaka 2810



SEAT Sedile	BACK Schienale	FRAME Telaio	ASH Frassino
BL2 AZ1 VE2 VE1 RB RA MO MC	BL2 AZ1 VE2 VE1 RB RA MO MC	BL2 AZ1 VE2 VE1 RB RA MO MC	<b>€ 279,00</b> Lacquered with visible grains Laccato a poro aperto

### FINISHES / Finiture



### PACKING / Imballo



### TECHNICAL DETAILS / Dettagli tecnici



**SAFETY, STRENGTH and DURABILITY TESTS**  
 Prove di sicurezza, resistenza e durata  
 EN 1728:2012+AC2013  
 EN 16139:2013 level 2

## Osaka 2811



SEAT Sedile	BACK Schienale	FRAME Telaio	ASH Frassino	ASH STAINED ON SAMPLE Frassino tinto campione
A	A	FR-N1-GC- BI-AN	<b>€ 384,00</b>	<b>€ 408,00</b>
C*	C*		<b>€ 413,00</b>	<b>€ 437,00</b>
D40÷D44	D40÷D44	TC	<b>€ 447,00</b>	<b>€ 471,00</b>
G	G		<b>€ 499,00</b>	<b>€ 523,00</b>
H*	H*	TC	<b>€ 425,00</b>	<b>€ 449,00</b>
N	N		<b>€ 524,00</b>	<b>€ 548,00</b>
P*	P*	CL**	<b>€ 587,00</b>	<b>€ 612,00</b>
TC**	TC**		<b>€ 384,00</b>	<b>€ 408,00</b>
CL**	CL**		<b>€ 390,00</b>	<b>€ 414,00</b>

\*\*TC/CL = Minimum order 10 pcs each fabric colour  
 TC/CL = Ordine minimo 10 pz per colore/tessuto

\*Excluding / Escluso C36+C39, H140+H143, PBS-PCO-PMS-PVE

### FINISHES / Finiture



### PACKING / Imballo



### TECHNICAL DETAILS / Dettagli tecnici



**SAFETY, STRENGTH and DURABILITY TESTS**  
 Prove di sicurezza, resistenza e durata  
 EN 1728:2012+AC2013  
 EN 16139:2013 level 2

For fabrics see page 367  
 Per i tessuti si veda a p. 367

### FABRIC REQUIRED / Fabbisogno tessuto

1 pc: Lin Mtrs 0,95 (h 1,40) fabric/tessuto  
 1 pc: Square Mtrs 1,40 mid-grain leather/pelle mezzo fiore

Upcharge for double-colour upholstery: fabric € 10,00, leather € 33,00  
 Supplemento tappezzeria bicolore: tessuto € 10,00, pelle € 33,00



# Osaka 2815



SEAT Sedile	BACK Schienale	FRAME Telaio	ASH Frassino	ASH STAINED ON SAMPLE Frassino tinto campione
FR-N1-GC- BI-AN	FR-N1-GC- BI-AN	FR-N1-GC- BI-AN	<b>€ 323,00</b>	<b>€ 347,00</b>
TC	TC	TC		

FINISHES / Finiture

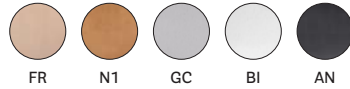

PACKING / Imballo



TECHNICAL DETAILS / Dettagli tecnici



**SAFETY, STRENGTH and DURABILITY TESTS**  
 Prove di sicurezza, resistenza e durata  
 EN 1728:2012+AC2013  
 EN 16139:2013 level 2

# Osaka 2815



SEAT Sedile	BACK Schienale	FRAME Telaio	ASH Frassino
BL2 AZ1 VE2 VE1 RB RA MO MC	BL2 AZ1 VE2 VE1 RB RA MO MC	BL2 AZ1 VE2 VE1 RB RA MO MC	<b>€ 335,00</b> Lacquered with visible grains Laccato a poro aperto

FINISHES / Finiture



PACKING / Imballo



TECHNICAL DETAILS / Dettagli tecnici



**SAFETY, STRENGTH and DURABILITY TESTS**  
 Prove di sicurezza, resistenza e durata  
 EN 1728:2012+AC2013  
 EN 16139:2013 level 2

# Osaka 2816



SEAT Sedile	BACK Schienale	FRAME Telaio	ASH Frassino	ASH STAINED ON SAMPLE Frassino tinto campione
A	A		<b>€ 465,00</b>	<b>€ 489,00</b>
C*	C*		<b>€ 498,00</b>	<b>€ 522,00</b>
D40÷D44	D40÷D44		<b>€ 537,00</b>	<b>€ 561,00</b>
G	G	FR-N1-GC- BI-AN	<b>€ 598,00</b>	<b>€ 622,00</b>
H*	H*		<b>€ 512,00</b>	<b>€ 536,00</b>
N	N	TC	<b>€ 626,00</b>	<b>€ 651,00</b>
P*	P*		<b>€ 672,00</b>	<b>€ 696,00</b>
TC**	TC**		<b>€ 465,00</b>	<b>€ 489,00</b>
CL**	CL**		<b>€ 471,00</b>	<b>€ 495,00</b>

\*\*TC/CL = Minimum order 10 pcs each fabric colour  
 TC/CL = Ordine minimo 10 pz per colore/tessuto

\*Excluding / Escluso C36+C39, H140+H143, PBS-PCO-PMS-PVE

FINISHES / Finiture



PACKING / Imballo



TECHNICAL DETAILS / Dettagli tecnici



**SAFETY, STRENGTH and DURABILITY TESTS**  
 Prove di sicurezza, resistenza e durata  
 EN 1728:2012+AC2013  
 EN 16139:2013 level 2

For fabrics see page 367  
 Per i tessuti si veda a p. 367

FABRIC REQUIRED / Fabbisogno tessuto

1 pc: Lin Mtrs 0,95 (h 1,40) fabric/tessuto  
 1 pc: Square Mtrs 1,40 mid-grain leather/pelle mezzo fiore

Upcharge for double-colour upholstery: fabric € 10,00, leather € 50,00  
 Supplemento tappezzeria bicolore: tessuto € 10,00, pelle € 50,00



# Osaka Metal 5711



SEAT Sedile	BACK Schienale	FRAME Telaio	ASH Frassino				ASH STAINED ON SAMPLE Frassino tinto campione			
			POWDER COATED Verniciato	GOLD LACQUERED Laccato oro	CHROMED Cromato	ANTIQU BRASS Ottone anticato	POWDER COATED Verniciato	GOLD LACQUERED Laccato oro	CHROMED Cromato	ANTIQU BRASS Ottone anticato
FR-MC- MO-AN	FR-MC- MO-AN	Ø 16	€ 172,00	€ 227,00	€ 172,00	€ 238,00				
TC	TC		€ 185,00	€ 240,00	€ 185,00	€ 251,00				

FINISHES / Finiture



PACKING / Imballo



TECHNICAL DETAILS / Dettagli tecnici



SAFETY, STRENGTH and DURABILITY TESTS  
Prove di sicurezza, resistenza e durata  
EN 1728:2012+AC2013  
EN 16139:2013 level 2

# Osaka Metal 5714



SEAT Sedile	BACK Schienale	FRAME Telaio	ASH Frassino				ASH STAINED ON SAMPLE Frassino tinto campione			
			POWDER COATED Verniciato	GOLD LACQUERED Laccato oro	CHROMED Cromato	ANTIQU BRASS Ottone anticato	POWDER COATED Verniciato	GOLD LACQUERED Laccato oro	CHROMED Cromato	ANTIQU BRASS Ottone anticato
FR-MC- MO-AN	FR-MC- MO-AN	Ø 11	€ 181,00	€ 236,00	€ 181,00	€ 247,00				
TC	TC		€ 194,00	€ 249,00	€ 194,00	€ 260,00				

FINISHES / Finiture



PACKING / Imballo



TECHNICAL DETAILS / Dettagli tecnici

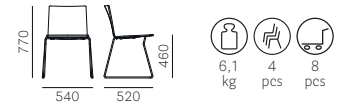

SAFETY, STRENGTH and DURABILITY TESTS  
Prove di sicurezza, resistenza e durata  
EN 1728:2012+AC2013  
EN 16139:2013 level 2

# Osaka Metal 5721

SOFT



SEAT Sedile	BACK Schienale	FRAME Telaio	POWDER COATED Verniciato	GOLD LACQUERED Laccato oro	CHROMED Cromato	ANTIQU BRASS Ottone anticato
A	A	Ø 16	€ 278,00	€ 333,00	€ 278,00	€ 344,00
C*	C*		€ 305,00	€ 360,00	€ 305,00	€ 371,00
D40+D44 D120+D123	D40+D44 D120+D123		€ 335,00	€ 390,00	€ 335,00	€ 401,00
G	G		€ 383,00	€ 438,00	€ 383,00	€ 449,00
H	H		€ 316,00	€ 371,00	€ 316,00	€ 382,00
N	N		€ 405,00	€ 460,00	€ 405,00	€ 471,00
P*	P*		€ 464,00	€ 519,00	€ 464,00	€ 530,00
TC**	TC**		€ 278,00	€ 333,00	€ 278,00	€ 344,00
CL**	CL**		€ 284,00	€ 339,00	€ 284,00	€ 350,00

\*\*TC/CL = Minimum order 10 pcs each fabric colour  
TC/CL = Ordine minimo 10 pz per colore/tessuto

\*Excluding / Escluso C36+C39, PBS-PCO-PMS-PVE

For fabrics see page 367  
Per i tessuti si veda a p. 367

Upcharge for double-colour upholstery: fabric € 10,00, leather € 33,00  
Supplemento tappezzeria bicolore: tessuto € 10,00, pelle € 33,00

PACKING / Imballo



TECHNICAL DETAILS / Dettagli tecnici



FABRIC REQUIRED / Fabbisogno tessuto

1 pc: Lin Mtrs 0,95 (h 1,40) fabric/tessuto  
1 pc: Square Mtrs 1,40 mid-grain leather/pelle mezzo fiore

SAFETY, STRENGTH and DURABILITY TESTS  
Prove di sicurezza, resistenza e durata  
EN 1728:2012+AC2013  
EN 16139:2013 level 2

For colours and finishes see at page 362  
Per colori e finiture vedere da pagina 362

# Osaka Metal 5724

SOFT



SEAT Sedile	BACK Schienale	FRAME Telaio	POWDER COATED Verniciato	GOLD LACQUERED Laccato oro	CHROMED Cromato	ANTIQU BRASS Ottone antico
A	A		€ 287,00	€ 342,00	€ 287,00	€ 353,00
C*	C*		€ 313,00	€ 368,00	€ 313,00	€ 379,00
D40+D44 D120+D123	D40+D44 D120+D123		€ 344,00	€ 399,00	€ 344,00	€ 410,00
G	G	∅ 11	€ 392,00	€ 447,00	€ 392,00	€ 458,00
H	H		€ 324,00	€ 379,00	€ 324,00	€ 390,00
N	N		€ 414,00	€ 469,00	€ 414,00	€ 480,00
P*	P*		€ 472,00	€ 527,00	€ 472,00	€ 538,00
TC**	TC**		€ 287,00	€ 342,00	€ 287,00	€ 353,00
CL**	CL**		€ 293,00	€ 348,00	€ 293,00	€ 359,00

\*\*TC/CL = Minimum order 10 pcs each fabric colour  
TC/CL = Ordine minimo 10 pz per colore/tessuto

\*Excluding / Escluso C36+C39, PBS-PCO-PMS-PVE

For fabrics see page 367  
Per i tessuti si veda a p. 367

Upcharge for double-colour upholstery: fabric € 10,00, leather € 33,00  
Supplemento tappezzeria bicolore: tessuto € 10,00, pelle € 33,00

PACKING / Imballo

TECHNICAL DETAILS / Dettagli tecnici

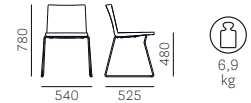

FABRIC REQUIRED / Fabbisogno tessuto

1pc: Lin Mtrs 0,95 (h 1,40) fabric/tessuto  
1pc: Square Mtrs 1,40 mid-grain leather/pelle mezzo fiore

SAFETY, STRENGTH and DURABILITY TESTS  
Prove di sicurezza, resistenza e durata  
EN 1728:2012+AC2013  
EN 16139:2013 level 2

# Osaka Metal 5712



SEAT Sedile	BACK Schienale	FRAME Telaio	ASH Frassino				ASH STAINED ON SAMPLE Frassino tinto campione			
			POWDER COATED Verniciato	GOLD LACQUERED Laccato oro	CHROMED Cromato	ANTIQU BRASS Ottone antico	POWDER COATED Verniciato	GOLD LACQUERED Laccato oro	CHROMED Cromato	ANTIQU BRASS Ottone antico
FR-MC-MO-AN	FR-MC-MO-AN	∅ 16	€ 240,00	€ 302,00	€ 247,00	€ 313,00				
TC	TC						€ 253,00	€ 315,00	€ 260,00	€ 326,00

Armrest finish: FR only  
Finitura bracciolo: solo FR

FINISHES / Finiture



PACKING / Imballo

TECHNICAL DETAILS / Dettagli tecnici



Minimum order q.ty: 20 pcs  
Ordine minimo: 20pz

SAFETY, STRENGTH and DURABILITY TESTS  
Prove di sicurezza, resistenza e durata  
EN 1728:2012+AC2013  
EN 16139:2013 level 2

# Osaka Metal 5715



SEAT Sedile	BACK Schienale	FRAME Telaio	ASH Frassino				ASH STAINED ON SAMPLE Frassino tinto campione			
			POWDER COATED Verniciato	GOLD LACQUERED Laccato oro	CHROMED Cromato	ANTIQU BRASS Ottone antico	POWDER COATED Verniciato	GOLD LACQUERED Laccato oro	CHROMED Cromato	ANTIQU BRASS Ottone antico
FR-MC-MO-AN	FR-MC-MO-AN	∅ 11	€ 252,00	€ 321,00	€ 266,00	€ 332,00				
TC	TC						€ 266,00	€ 334,00	€ 279,00	€ 345,00

Armrest finish: FR only  
Finitura bracciolo: solo FR

FINISHES / Finiture



PACKING / Imballo

TECHNICAL DETAILS / Dettagli tecnici

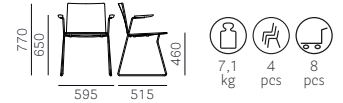

Minimum order q.ty: 20 pcs  
Ordine minimo: 20pz

SAFETY, STRENGTH and DURABILITY TESTS  
Prove di sicurezza, resistenza e durata  
EN 1728:2012+AC2013  
EN 16139:2013 level 2

For colours and finishes see at page 362  
Per colori e finiture vedere da pagina 362





## Osaka Metal 5722

SOFT



SEAT Sedile	BACK Schienale	FRAME Telaio	POWDER COATED Verniciato	GOLD LACQUERED Laccato oro	CHROMED Cromato	ANTIQU BRASS Ottone anticato
A	A		€ 346,00	€ 408,00	€ 353,00	€ 419,00
C*	C*		€ 373,00	€ 434,00	€ 379,00	€ 445,00
D40*D44 D120*D123	D40*D44 D120*D123		€ 404,00	€ 465,00	€ 410,00	€ 476,00
G	G	∅ 16	€ 451,00	€ 513,00	€ 458,00	€ 524,00
H	H		€ 384,00	€ 445,00	€ 390,00	€ 456,00
N	N		€ 473,00	€ 535,00	€ 480,00	€ 549,00
P*	P*		€ 532,00	€ 593,00	€ 538,00	€ 604,00
TC**	TC**		€ 346,00	€ 408,00	€ 353,00	€ 419,00
CL**	CL**		€ 352,00	€ 414,00	€ 359,00	€ 425,00

\*\*TC/CL = Minimum order 10 pcs each fabric colour  
TC/CL = Ordine minimo 10 pz per colore/tessuto

\*Excluding / Escluso C36+C39, PBS-PCO-PMS-PVE

Armrest finish: FR only  
Finitura bracciolo: solo FR

For fabrics see page 367  
Per i tessuti si veda a p. 367

SAFETY, STRENGTH and DURABILITY TESTS  
Prove di sicurezza, resistenza e durata  
EN 1728:2012+AC2013  
EN 16139:2013 level 2

Upcharge for double-colour upholstery: fabric € 10,00, leather € 33,00  
Supplemento tappezzeria bicolore: tessuto € 10,00, pelle € 33,00

PACKING / Imballo

TECHNICAL DETAILS / Dettagli tecnici



FABRIC REQUIRED / Fabbisogno tessuto

1pc: Lin Mtrs 0,95 (h 1,40) fabric/tessuto  
1pc: Square Mtrs 1,40 mid-grain leather/pelle mezzo fiore



## Osaka Metal 5725

SOFT



SEAT Sedile	BACK Schienale	FRAME Telaio	POWDER COATED Verniciato	GOLD LACQUERED Laccato oro	CHROMED Cromato	ANTIQU BRASS Ottone anticato
A	A		€ 359,00	€ 427,00	€ 372,00	€ 438,00
C*	C*		€ 385,00	€ 453,00	€ 398,00	€ 464,00
D40*D44 D120*D123	D40*D44 D120*D123		€ 416,00	€ 484,00	€ 429,00	€ 495,00
G	G	∅ 11	€ 463,00	€ 531,00	€ 476,00	€ 542,00
H	H		€ 396,00	€ 464,00	€ 409,00	€ 475,00
N	N		€ 486,00	€ 554,00	€ 499,00	€ 568,00
P*	P*		€ 544,00	€ 612,00	€ 557,00	€ 623,00
TC**	TC**		€ 359,00	€ 427,00	€ 372,00	€ 438,00
CL**	CL**		€ 364,00	€ 432,00	€ 377,00	€ 443,00

\*\*TC/CL = Minimum order 10 pcs each fabric colour  
TC/CL = Ordine minimo 10 pz per colore/tessuto

\*Excluding / Escluso C36+C39, PBS-PCO-PMS-PVE

Armrest finish: FR only  
Finitura bracciolo: solo FR

For fabrics see page 367  
Per i tessuti si veda a p. 367

SAFETY, STRENGTH and DURABILITY TESTS  
Prove di sicurezza, resistenza e durata  
EN 1728:2012+AC2013  
EN 16139:2013 level 2

Upcharge for double-colour upholstery: fabric € 10,00, leather € 33,00  
Supplemento tappezzeria bicolore: tessuto € 10,00, pelle € 33,00

PACKING / Imballo

TECHNICAL DETAILS / Dettagli tecnici



FABRIC REQUIRED / Fabbisogno tessuto

1pc: Lin Mtrs 0,95 (h 1,40) fabric/tessuto  
1pc: Square Mtrs 1,40 mid-grain leather/pelle mezzo fiore



## Osaka Metal 5716



SEAT Sedile	BACK Schienale	FRAME Telaio	ASH Frassino				ASH STAINED ON SAMPLE Frassino tinto campione			
			POWDER COATED Verniciato	GOLD LACQUERED Laccato oro	CHROMED Cromato	ANTIQU BRASS Ottone anticato	POWDER COATED Verniciato	GOLD LACQUERED Laccato oro	CHROMED Cromato	ANTIQU BRASS Ottone anticato
FR-MC-MO-AN	FR-MC-MO-AN	∅ 11 H650	€ 185,00	€ 244,00	€ 189,00	€ 260,00				
TC	TC						€ 198,00	€ 257,00	€ 202,00	€ 273,00

FINISHES / Finiture



PACKING / Imballo

TECHNICAL DETAILS / Dettagli tecnici

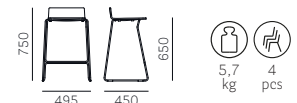

For colours and finishes see at page 362  
Per colori e finiture vedere da pagina 362



# Osaka Metal 5717

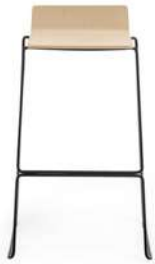

SEAT Sedile	BACK Schienale	FRAME Telaio	ASH Frassino				ASH STAINED ON SAMPLE Frassino tinto campione			
			POWDER COATED Verniciato	GOLD LACQUERED Laccato oro	CHROMED Cromato	ANTIQU BRASS Ottone anticato	POWDER COATED Verniciato	GOLD LACQUERED Laccato oro	CHROMED Cromato	ANTIQU BRASS Ottone anticato
FR-MC- MO-AN	FR-MC- MO-AN	Ø 11 H750	€ 187,00	€ 246,00	€ 191,00	€ 262,00				
TC	TC						€ 201,00	€ 259,00	€ 204,00	€ 275,00

FINISHES / Finiture



PACKING / Imballo



TECHNICAL DETAILS / Dettagli tecnici

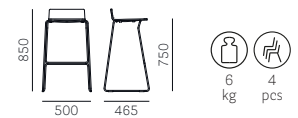

# Osaka Metal 5729

SOFT  
LOUNGE



SEAT Sedile	BACK Schienale	FRAME Telaio	POWDER COATED Verniciato	GOLD LACQUERED Laccato oro
			A	A
C*	C*		€ 447,00	€ 502,00
D40+D44 D120+D123	D40+D44 D120+D123	Ø 20	€ 487,00	€ 542,00
G	G		€ 546,00	€ 601,00
H	H		€ 461,00	€ 516,00
N	N		€ 574,00	€ 629,00
P*	P*		€ 637,00	€ 692,00
TC**	TC**		€ 414,00	€ 469,00
CL**	CL**		€ 420,00	€ 475,00

\*\*TC/CL = Minimum order 10 pcs each fabric colour  
TC/CL = Ordine minimo 10 pz per colore/tessuto

\*Excluding / Escluso C36+C39, PBS-PCO-PMS-PVE

Armrest finish: FR only  
Finitura bracciolo: solo FR

For fabrics see page 367  
Per i tessuti si veda a p. 367

Upcharge for double-colour upholstery: fabric € 10,00, leather € 33,00  
Supplemento tappezzeria bicolore: tessuto € 10,00, pelle € 33,00

PACKING / Imballo



FABRIC REQUIRED / Fabbisogno tessuto  
1pc: Lin Mtrs 1,10 (h 1,40)

TECHNICAL DETAILS / Dettagli tecnici



SAFETY, STRENGTH and DURABILITY TESTS  
Prove di sicurezza, resistenza e durata  
EN 1728:2012+AC2013  
EN 16139:2013 level 2

# Panarea 3675



SEAT Sedile	BACK Schienale	FRAME Telaio	POWDER COATED Verniciato
D22+D26 D110+D115 D130+D133	Ø 20 + Cord/Corda	Ø 20	€ 460,00

For fabrics see page 367  
Per i tessuti si veda a p. 367

CORD FINISHES / Finiture corda



POWDER COATED FINISHES / Finiture verniciato



For colours and finishes see at page 362  
Per colori e finiture vedere da pagina 362

PACKING / Imballo



TECHNICAL DETAILS / Dettagli tecnici



SAFETY, STRENGTH and DURABILITY TESTS  
Prove di sicurezza, resistenza e durata  
EN 1728:2012+AC2013  
EN 581-1:2017

## Panarea 3675.8

Cushion only  
Solo cuscino



BACK Schienale	FABRIC Tessuto
D22+D26 D110+D115 D130+D133	€ 72,00

For fabrics see page 367  
Per i tessuti si veda a p. 367

TECHNICAL DETAILS / Dettagli tecnici

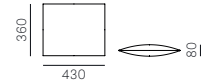

## Panarea 3678



SEAT Sedile	BACK Schienale	FRAME Telaio	POWDER COATED Verniciato
D22+D26 D110+D115 D130+D133	Ø 20 + Cord/Corda	Ø 20 H770	€ 520,00

For fabrics see page 367  
Per i tessuti si veda a p. 367

CORD FINISHES / Finiture corda



POWDER COATED FINISHES / Finiture verniciato



PACKING / Imballo



TECHNICAL DETAILS / Dettagli tecnici



## Panarea 3679

LOUNGE



SEAT Sedile	BACK Schienale	FRAME Telaio	POWDER COATED Verniciato
D22+D26 D110+D115 D130+D133	Ø 20 + Cord/Corda	Ø 20	€ 879,00

For fabrics see page 367  
Per i tessuti si veda a p. 367

CORD FINISHES / Finiture corda



POWDER COATED FINISHES / Finiture verniciato



Optional protective cover available on request see page 346  
Disponibile a richiesta la copertura protettiva accessorio si veda a p. 346

PACKING / Imballo



TECHNICAL DETAILS / Dettagli tecnici



SAFETY, STRENGTH and DURABILITY TESTS  
Prove di sicurezza, resistenza e durata  
EN 1728:2012+AC2013  
EN 581-1:2017

## Pasha 660



SEAT Sedile	BACK Schienale	FRAME Telaio	POLYCARBONATE Policarbonato
PC	PC	PC	<b>€ 231,00</b>

PC FINISHES / Finiture PC

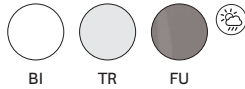

**SAFETY, STRENGTH and DURABILITY TESTS**  
Prove di sicurezza, resistenza e durata  
EN 1728:2000

PACKING / Imballo



TECHNICAL DETAILS / Dettagli tecnici

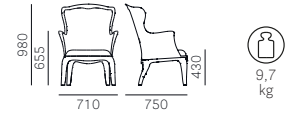

## Pasha 660/CL1

Fire retardant version  
Versione ignifuga



SEAT Sedile	BACK Schienale	FRAME Telaio	POLYCARBONATE Policarbonato
PC	PC	PC	<b>€ 266,00</b>

Minimum order 200 pcs each colour  
Ordine minimo 200 pz per colore

PC FINISHES / Finiture PC

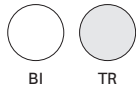

**SAFETY, STRENGTH and DURABILITY TESTS**  
Prove di sicurezza, resistenza e durata  
EN 1728:2000

PACKING / Imballo



TECHNICAL DETAILS / Dettagli tecnici

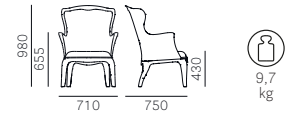

## Pasha 660.3

Cushion only  
Solo cuscino



SEAT Sedile	FABRIC Tessuto
C36+C39 fabric / tessuto	<b>€ 135,00</b>
D80+D89 fabric / tessuto	<b>€ 132,00</b>
H40+H53 velvet / velluto	<b>€ 115,00</b>

For fabrics see page 367  
Per i tessuti si veda a p. 367

PACKING / Imballo



TECHNICAL DETAILS / Dettagli tecnici



## Pasha 660.8

Fabric covering only  
Solo vestina



SEAT Sedile	BACK Schienale	FRAME Telaio	FABRIC Tessuto
A10	A10	A10	<b>€ 174,00</b>

COVERING FINISHES / Finiture vestina



A10

RIM FINISHES / Finiture bordino



A10

PACKING / Imballo



MC 0,056

TECHNICAL DETAILS / Dettagli tecnici

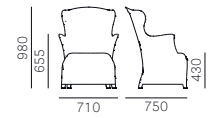

1 kg

## Pasha 661

POUF



SEAT Sedile	FRAME Telaio	POLYCARBONATE Policarbonato
PC	PC	<b>€ 105,00</b>

PC FINISHES / Finiture PC



BI

TR

FU



NE

PACKING / Imballo



MC 0,21

TECHNICAL DETAILS / Dettagli tecnici



4 kg

## Pasha 661/CL1

POUF

Fire retardant version  
Versione ignifuga



SEAT Sedile	FRAME Telaio	POLYCARBONATE Policarbonato
PC	PC	<b>€ 121,00</b>

Minimum order 200 pcs each colour  
Ordine minimo 200 pz per colore

PC FINISHES / Finiture PC



BI

TR

PACKING / Imballo



MC 0,21

TECHNICAL DETAILS / Dettagli tecnici



4 kg

## Pasha 662

Tray only  
Solo vassoio



SEAT Sedile	FRAME Telaio	THERMOFORMED METHACRYLATE Metacrilato termoformato
ME	ME	€ 120,00

ME FINISHES / Finiture ME



BI



NE

PACKING / Imballo



TECHNICAL DETAILS / Dettagli tecnici

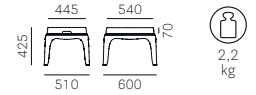

## Pasha 663

Floating tray  
Vassoio galleggiante



SEAT Sedile	FRAME Telaio	THERMOFORMED METHACRYLATE Metacrilato termoformato
ME	ME	€ 130,00

ME FINISHES / Finiture ME



BI





PACKING / Imballo



TECHNICAL DETAILS / Dettagli tecnici



## Permanent 4726-4727

CODE Codice	SEAT Sedile	FRAME Telaio	BLACK POWDER COATED Verniciato nero	POWDER COATED Verniciato	CHROMED Cromato	BRUSHED S/STEEL Inox satinato
 4726	Frame only / Solo telaio	Ø220	€ 149,00	€ 156,00	€ 195,00	€ 242,00
	A		€ 192,00	€ 199,00	€ 238,00	€ 285,00
	C *		€ 204,00	€ 211,00	€ 250,00	€ 297,00
	G		€ 238,00	€ 245,00	€ 284,00	€ 331,00
	H *		€ 206,00	€ 213,00	€ 252,00	€ 299,00
	P *		€ 250,00	€ 257,00	€ 296,00	€ 343,00
	TC **		€ 192,00	€ 199,00	€ 238,00	€ 285,00
	CL **		€ 198,00	€ 205,00	€ 244,00	€ 291,00
	PG		€ 171,00	€ 178,00	€ 217,00	€ 264,00
S_TX	**TC/CL= Minimum order 10 pcs each fabric colour TC/CL= Ordine minimo 10 pz per colore/tessuto					
 S350CON	A	Ø220	€ 210,00	€ 217,00	€ 256,00	€ 303,00
	C *		€ 226,00	€ 233,00	€ 272,00	€ 319,00
	G		€ 274,00	€ 281,00	€ 320,00	€ 367,00
	H *		€ 230,00	€ 237,00	€ 276,00	€ 323,00
	P *		€ 290,00	€ 297,00	€ 336,00	€ 383,00
	TC **		€ 210,00	€ 217,00	€ 256,00	€ 303,00
	CL **		€ 215,00	€ 222,00	€ 261,00	€ 308,00
	PG		€ 173,00	€ 180,00	€ 219,00	€ 266,00
	S350CON		**TC/CL= Minimum order 10 pcs each fabric colour TC/CL= Ordine minimo 10 pz per colore/tessuto			
 4727	Frame only / Solo telaio	Ø220	€ 189,00	€ 197,00	€ 235,00	€ 282,00
	A		€ 232,00	€ 240,00	€ 278,00	€ 325,00
	C *		€ 244,00	€ 252,00	€ 290,00	€ 337,00
	G		€ 278,00	€ 286,00	€ 324,00	€ 371,00
	H *		€ 246,00	€ 254,00	€ 292,00	€ 339,00
	P *		€ 290,00	€ 298,00	€ 336,00	€ 383,00
	TC **		€ 232,00	€ 240,00	€ 278,00	€ 325,00
	CL **		€ 238,00	€ 246,00	€ 284,00	€ 331,00
	PG		€ 211,00	€ 219,00	€ 257,00	€ 304,00
S_TX	**TC/CL= Minimum order 10 pcs each fabric colour TC/CL= Ordine minimo 10 pz per colore/tessuto					
 S350CON	A	Ø220	€ 250,00	€ 258,00	€ 296,00	€ 343,00
	C *		€ 266,00	€ 274,00	€ 312,00	€ 359,00
	G		€ 314,00	€ 322,00	€ 360,00	€ 407,00
	H *		€ 270,00	€ 278,00	€ 316,00	€ 363,00
	P *		€ 330,00	€ 338,00	€ 376,00	€ 423,00
	TC **		€ 250,00	€ 258,00	€ 296,00	€ 343,00
	CL **		€ 255,00	€ 263,00	€ 301,00	€ 348,00
	PG		€ 213,00	€ 221,00	€ 259,00	€ 306,00
	S350CON		**TC/CL= Minimum order 10 pcs each fabric colour TC/CL= Ordine minimo 10 pz per colore/tessuto			

\*Excluding / Escluso C36+C39, H140+H143, PBS-PCO-PMS-PVE

For fabrics see page 367  
Per i tessuti si veda a p. 367

### TECHNICAL DETAILS / Dettagli tecnici

#### 4726 S\_TX







1 pc KD MC 0,081 40pcs

FABRIC REQUIRED / Fabbisogno tessuto  
1 pc: Lin Mtrs 0,35 (h 1,40)

#### 4726 S350CON







1 pc KD MC 0,127 40pcs

FABRIC REQUIRED / Fabbisogno tessuto  
1 pc: Lin Mtrs 0,60 (h 1,40)

#### 4727 S\_TX







1 pc KD MC 0,093 40pcs

FABRIC REQUIRED / Fabbisogno tessuto  
1 pc: Lin Mtrs 0,35 (h 1,40)

#### 4727 S350CON







1 pc KD MC 0,139 40pcs

FABRIC REQUIRED / Fabbisogno tessuto  
1 pc: Lin Mtrs 0,60 (h 1,40)

For colours and finishes see at page 362  
Per colori e finiture vedere da pagina 362

## Permanent 4736

S\_TX



SEAT Sedile	FRAME Telaio	CHROMED Cromato	BRUSHED S/STEEL Inox satinato
Frame only / Solo telaio		€ 204,00	€ 226,00
A		€ 247,00	€ 269,00
C*		€ 259,00	€ 281,00
G		€ 293,00	€ 315,00
H*	Ø 280	€ 261,00	€ 283,00
P*		€ 305,00	€ 327,00
TC**		€ 247,00	€ 269,00
CL**		€ 253,00	€ 275,00
PG		€ 226,00	€ 248,00

\*\*TC/CL = Minimum order 10 pcs each fabric colour  
TC/CL = Ordine minimo 10 pz per colore/tessuto

\*Excluding / Escluso C36+C39, H140+H143, PBS-PCO-PMS-PVE

For fabrics see page 367  
Per i tessuti si veda a p. 367

## PACKING / Imballo



## FABRIC REQUIRED / Fabbisogno tessuto

1pc: Lin Mtrs 0,35 (h 1,40)

## TECHNICAL DETAILS / Dettagli tecnici

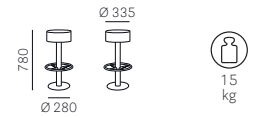

## Permanent 4737

S\_TX



SEAT Sedile	FRAME Telaio	CHROMED Cromato	BRUSHED S/STEEL Inox satinato
Frame only / Solo telaio		€ 245,00	€ 266,00
A		€ 288,00	€ 309,00
C*		€ 300,00	€ 321,00
G		€ 334,00	€ 355,00
H*	Ø 280	€ 302,00	€ 323,00
P*		€ 346,00	€ 367,00
TC**		€ 288,00	€ 309,00
CL**		€ 294,00	€ 315,00
PG		€ 267,00	€ 288,00

\*\*TC/CL = Minimum order 10 pcs each fabric colour  
TC/CL = Ordine minimo 10 pz per colore/tessuto

\*Excluding / Escluso C36+C39, H140+H143, PBS-PCO-PMS-PVE

For fabrics see page 367  
Per i tessuti si veda a p. 367

## PACKING / Imballo



## FABRIC REQUIRED / Fabbisogno tessuto

1pc: Lin Mtrs 0,35 (h 1,40)

## TECHNICAL DETAILS / Dettagli tecnici

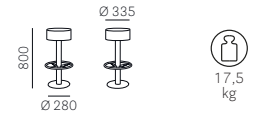



## Plural

Without armrests  
Senza braccioli



P020\_USB

USB optional kit  
integrated into the top  
Kit USB accessorio  
integrato nel ripiano



CODE Codice	SEAT Sedile	BACK Schienale	POWDER COATED Verniciato	CHROMED Cromato
<b>P02003</b>	PPL	PPL	<b>€ 853,00</b>	<b>€ 1.155,00</b>
	Floor fixing kit: surcharge € 55,00 (Item P02003_FIX) Kit di fissaggio a terra: supplemento € 55,00 (Art.P02003_FIX)			
<b>P02004</b>	PPL	PPL	<b>€ 1.001,00</b>	<b>€ 1.430,00</b>
	Floor fixing kit: surcharge € 55,00 (Item P02004_FIX) Kit di fissaggio a terra: supplemento € 55,00 (Art.P02004_FIX)			
<b>P02006</b>	PPL	PPL	<b>€ 1.540,00</b>	<b>€ 2.035,00</b>
	Floor fixing kit: surcharge € 83,00 (Item P02006_FIX) Kit di fissaggio a terra: supplemento € 83,00 (Art.P02006_FIX)			
<b>P02009</b>	PPL	PPL	<b>€ 2.200,00</b>	<b>€ 2.893,00</b>
	Floor fixing kit: surcharge € 110,00 (Item P02009_FIX) Kit di fissaggio a terra: supplemento € 110,00 (Art.P02009_FIX)			
<b>P020_USB</b>	USB kit: surcharge € 77,00 (electrification excluded) Kit USB: supplemento € 77,00 (elettrificazione esclusa)			

### SAFETY, STRENGTH and DURABILITY TESTS

Prove di sicurezza, resistenza e durata

EN 1728:2012+AC2013

EN 16139:2013 level 2

(for P02003 - P02004)



PRODUCT CERTIFIED  
FOR LOW CHEMICAL  
EMISSIONS:  
UL.COM/CG  
UL 2818

### PPL FINISHES / Finiture PPL



BI

NE

BE

For colours and finishes see at page 362  
Per colori e finiture vedere da pagina 362

### TECHNICAL DETAILS / Dettagli tecnici

#### P02003

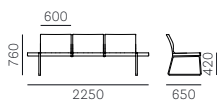

37  
kg

1 pc KD  
MC 0,395

#### P02004

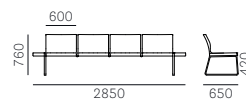

47  
kg

1 pc KD  
MC 0,40

#### P02006

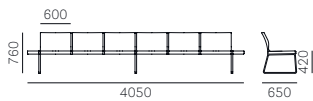

68  
kg

1 pc KD  
MC 0,73

#### P02009

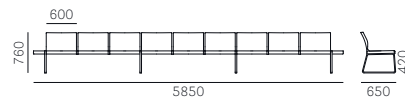

99  
kg

1 pc KD  
MC 1,04

## Plural

With armrests  
Con braccioli



CODE Codice	SEAT Sedile	BACK Schienale	POWDER COATED Verniciato	CHROMED Cromato
<b>P02013</b>	PPL	PPL	<b>€ 946,00</b>	<b>€ 1.419,00</b>
	Floor fixing kit: surcharge € 55,00 (Item P02013_FIX) Kit di fissaggio a terra: supplemento € 55,00 (Art.P02013_FIX)			
<b>P02014</b>	PPL	PPL	<b>€ 1.117,00</b>	<b>€ 1.705,00</b>
	Floor fixing kit: surcharge € 55,00 (Item P02014_FIX) Kit di fissaggio a terra: supplemento € 55,00 (Art.P02014_FIX)			
<b>P02016</b>	PPL	PPL	<b>€ 1.650,00</b>	<b>€ 2.453,00</b>
	Floor fixing kit: surcharge € 83,00 (Item P02016_FIX) Kit di fissaggio a terra: supplemento € 83,00 (Art.P02016_FIX)			
<b>P02019</b>	PPL	PPL	<b>€ 2.365,00</b>	<b>€ 3.476,00</b>
	Floor fixing kit: surcharge € 110,00 (Item P02019_FIX) Kit di fissaggio a terra: supplemento € 110,00 (Art.P02019_FIX)			
<b>P020_USB</b>	USB kit: surcharge € 77,00 (electrification excluded) Kit USB: supplemento € 77,00 (elettrificazione esclusa)			

### SAFETY, STRENGTH and DURABILITY TESTS

Prove di sicurezza, resistenza e durata

EN 1728:2012+AC2013

EN 16139:2013 level 2

(for P02013 - P02014)



PRODUCT CERTIFIED  
FOR LOW CHEMICAL  
EMISSIONS:  
UL.COM/CG  
UL 2818

### PPL FINISHES / Finiture PPL



BI

NE

BE

For colours and finishes see at page 362  
Per colori e finiture vedere da pagina 362

### TECHNICAL DETAILS / Dettagli tecnici

#### P02013

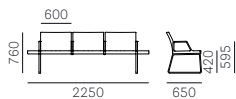

1 pc

KD  
MC 0,42

#### P02014

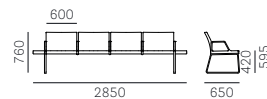

1 pc

KD  
MC 0,42

#### P02016

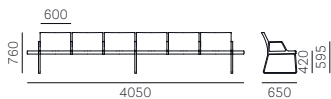

1 pc

KD  
MC 0,81

#### P02019

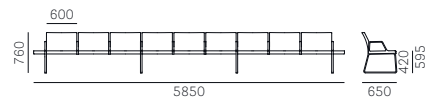

1 pc

KD  
MC 1,08

## Plural

With outside armrests  
Con braccioli esterni



P020\_USB

USB optional kit  
integrated into the top  
Kit USB accessorio  
integrato nel ripiano



CODE Codice	SEAT Sedile	BACK Schienale	POWDER COATED Verniciato	CHROMED Cromato
<b>P02023</b>	PPL	PPL	<b>€ 924,00</b>	<b>€ 1.342,00</b>
	Floor fixing kit: surcharge € 55,00 (Item P02023_FIX) Kit di fissaggio a terra: supplemento € 55,00 (Art.P02023_FIX)			
<b>P02024</b>	PPL	PPL	<b>€ 1.095,00</b>	<b>€ 1.584,00</b>
	Floor fixing kit: surcharge € 55,00 (Item P02024_FIX) Kit di fissaggio a terra: supplemento € 55,00 (Art.P02024_FIX)			
<b>P02026</b>	PPL	PPL	<b>€ 1.584,00</b>	<b>€ 2.200,00</b>
	Floor fixing kit: surcharge € 83,00 (Item P02026_FIX) Kit di fissaggio a terra: supplemento € 83,00 (Art.P02026_FIX)			
<b>P02029</b>	PPL	PPL	<b>€ 2.255,00</b>	<b>€ 3.058,00</b>
	Floor fixing kit: surcharge € 110,00 (Item P02029_FIX) Kit di fissaggio a terra: supplemento € 110,00 (Art.P02029_FIX)			
<b>P020_USB</b>	USB kit: surcharge € 77,00 (electrification excluded) Kit USB: supplemento € 77,00 (elettrificazione esclusa)			

### SAFETY, STRENGTH and DURABILITY TESTS

Prove di sicurezza, resistenza e durata

EN 1728:2012+AC2013

EN 16139:2013 level 2

(for P02023 - P02024)



PRODUCT CERTIFIED  
FOR LOW CHEMICAL  
EMISSIONS:  
UL.COM/CG  
UL 2818

### PPL FINISHES / Finiture PPL



For colours and finishes see at page 362  
Per colori e finiture vedere da pagina 362

### TECHNICAL DETAILS / Dettagli tecnici

P02023

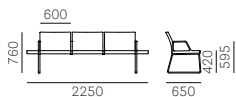

P02024

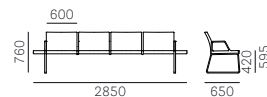

P02026

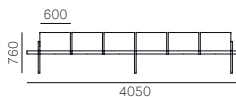

P02029

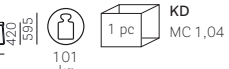

## Plural

SOFT  
Without armrests  
Senza braccioli



P020\_USB

USB optional kit  
integrated into the top  
Kit USB accessorio  
integrato nel ripiano



CODE Codice	SEAT Sedile	BACK Schienale	POWDER COATED Verniciato	CHROMED Cromato
P02103	A	PPL	€ 1.180,00	€ 1.482,00
	C*		€ 1.209,00	€ 1.512,00
	D40+D44		€ 1.246,00	€ 1.548,00
	G		€ 1.305,00	€ 1.608,00
	H*		€ 1.223,00	€ 1.525,00
Floor fixing kit: surcharge € 55,00 (Item P02103_FIX) Kit di fissaggio a terra: supplemento € 55,00 (Art.P02103_FIX)				
P02104	A	PPL	€ 1.437,00	€ 1.866,00
	C*		€ 1.477,00	€ 1.906,00
	D40+D44		€ 1.525,00	€ 1.954,00
	G		€ 1.604,00	€ 2.033,00
	H*		€ 1.494,00	€ 1.923,00
Floor fixing kit: surcharge € 55,00 (Item P02104_FIX) Kit di fissaggio a terra: supplemento € 55,00 (Art.P02104_FIX)				
P02106	A	PPL	€ 2.194,00	€ 2.689,00
	C*		€ 2.253,00	€ 2.748,00
	D40+D44		€ 2.326,00	€ 2.821,00
	G		€ 2.445,00	€ 2.940,00
	H*		€ 2.280,00	€ 2.775,00
Floor fixing kit: surcharge € 83,00 (Item P02106_FIX) Kit di fissaggio a terra: supplemento € 83,00 (Art.P02106_FIX)				
P02109	A	PPL	€ 3.181,00	€ 3.874,00
	C*		€ 3.270,00	€ 3.963,00
	D40+D44		€ 3.379,00	€ 4.072,00
	G		€ 3.557,00	€ 4.250,00
	H*		€ 3.309,00	€ 4.002,00
Floor fixing kit: surcharge € 110,00 (Item P02109_FIX) Kit di fissaggio a terra: supplemento € 110,00 (Art.P02109_FIX)				
P020_USB	USB kit: surcharge € 77,00 (electrification excluded) Kit USB: supplemento € 77,00 (elettrificazione esclusa)			

\* Excluding / Escluso C36+C39, H140+H143

### PPL FINISHES / Finiture PPL



For fabrics see page 367  
Per i tessuti si veda a p. 367

For colours and finishes see at page 362  
Per colori e finiture vedere da pagina 362

### SAFETY, STRENGTH and DURABILITY TESTS

Prove di sicurezza, resistenza e durata  
EN 1728:2012+AC2013  
EN 16139:2013 level 2  
(for P02103 - P02104)

### TECHNICAL DETAILS / Dettagli tecnici

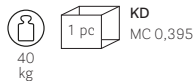
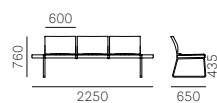

### P02104

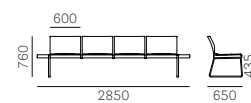

### P02106

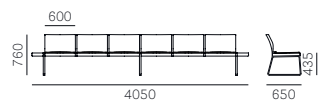

### P02109

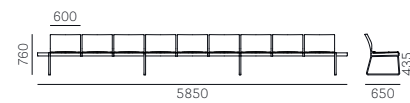

## Plural

SOFT  
With armrests  
Con braccioli



P020\_USB

USB optional kit  
integrated into the top  
Kit USB accessorio  
integrato nel ripiano



CODE Codice	SEAT Sedile	BACK Schienale	POWDER COATED Verniciato	CHROMED Cromato
P02113	A	PPL	€ 1.273,00	€ 1.746,00
	C*		€ 1.303,00	€ 1.776,00
	D40+D44		€ 1.339,00	€ 1.812,00
	G		€ 1.399,00	€ 1.872,00
	H*		€ 1.316,00	€ 1.789,00
Floor fixing kit: surcharge € 55,00 (Item P02113_FIX) Kit di fissaggio a terra: supplemento € 55,00 (Art.P02113_FIX)				
P02114	A	PPL	€ 1.553,00	€ 2.141,00
	C*		€ 1.592,00	€ 2.181,00
	D40+D44		€ 1.641,00	€ 2.229,00
	G		€ 1.720,00	€ 2.308,00
	H*		€ 1.610,00	€ 2.198,00
Floor fixing kit: surcharge € 55,00 (Item P02114_FIX) Kit di fissaggio a terra: supplemento € 55,00 (Art.P02114_FIX)				
P02116	A	PPL	€ 2.304,00	€ 3.107,00
	C*		€ 2.363,00	€ 3.166,00
	D40+D44		€ 2.436,00	€ 3.239,00
	G		€ 2.555,00	€ 3.358,00
	H*		€ 2.390,00	€ 3.193,00
Floor fixing kit: surcharge € 83,00 (Item P02116_FIX) Kit di fissaggio a terra: supplemento € 83,00 (Art.P02116_FIX)				
P02119	A	PPL	€ 3.346,00	€ 4.457,00
	C*		€ 3.435,00	€ 4.546,00
	D40+D44		€ 3.544,00	€ 4.655,00
	G		€ 3.722,00	€ 4.833,00
	H*		€ 3.474,00	€ 4.585,00
Floor fixing kit: surcharge € 110,00 (Item P02119_FIX) Kit di fissaggio a terra: supplemento € 110,00 (Art.P02119_FIX)				
P020_USB	USB kit: surcharge € 77,00 (electrification excluded) Kit USB: supplemento € 77,00 (elettrificazione esclusa)			

\* Excluding / Escluso C36+C39, H140+H143

### PPL FINISHES / Finiture PPL



For fabrics see page 367  
Per i tessuti si veda a p. 367

For colours and finishes see at page 362  
Per colori e finiture vedere da pagina 362

### SAFETY, STRENGTH and DURABILITY TESTS

Prove di sicurezza, resistenza e durata  
EN 1728:2012+AC2013  
EN 16139:2013 level 2  
(for P02113 - P02114)

### TECHNICAL DETAILS / Dettagli tecnici

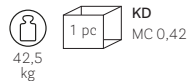
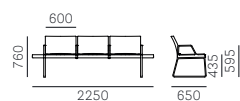

### P02114

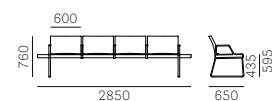

### P02116

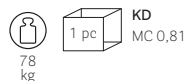
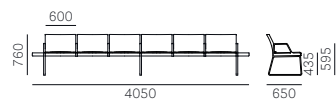

### P02119

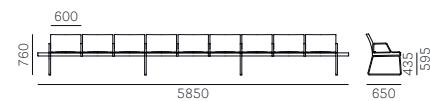

## Plural

SOFT  
With outside armrests  
Con braccioli esterni



CODE Codice	SEAT Sedile	BACK Schienale	POWDER COATED Verniciato	CHROMED Cromato
P02123	A		€ 1.251,00	€ 1.669,00
	C *		€ 1.281,00	€ 1.699,00
	D40+D44	PPL	€ 1.317,00	€ 1.735,00
	G		€ 1.377,00	€ 1.795,00
	H *		€ 1.294,00	€ 1.712,00
Floor fixing kit: surcharge € 55,00 (Item P02123_FIX) Kit di fissaggio a terra: supplemento € 55,00 (Art.P02123_FIX)				
P02124	A		€ 1.531,00	€ 2.020,00
	C *		€ 1.570,00	€ 2.060,00
	D40+D44	PPL	€ 1.619,00	€ 2.108,00
	G		€ 1.698,00	€ 2.187,00
	H *		€ 1.588,00	€ 2.077,00
Floor fixing kit: surcharge € 55,00 (Item P02124_FIX) Kit di fissaggio a terra: supplemento € 55,00 (Art.P02124_FIX)				
P02126	A		€ 2.238,00	€ 2.854,00
	C *		€ 2.297,00	€ 2.913,00
	D40+D44	PPL	€ 2.370,00	€ 2.986,00
	G		€ 2.489,00	€ 3.105,00
	H *		€ 2.324,00	€ 2.940,00
Floor fixing kit: surcharge € 83,00 (Item P02126_FIX) Kit di fissaggio a terra: supplemento € 83,00 (Art.P02126_FIX)				
P02129	A		€ 3.236,00	€ 4.039,00
	C *		€ 3.325,00	€ 4.128,00
	D40+D44	PPL	€ 3.434,00	€ 4.237,00
	G		€ 3.612,00	€ 4.415,00
	H *		€ 3.364,00	€ 4.167,00
Floor fixing kit: surcharge € 110,00 (Item P02129_FIX) Kit di fissaggio a terra: supplemento € 110,00 (Art.P02129_FIX)				
P020_USB	USB kit: surcharge € 77,00 (electrification excluded) Kit USB: supplemento € 77,00 (elettrificazione esclusa)			

\* Excluding / Escluso C36+C39, H140+H143

### PPL FINISHES / Finiture PPL



For fabrics see page 367  
Per i tessuti si veda a p. 367

For colours and finishes see at page 362  
Per colori e finiture vedere da pagina 362

### SAFETY, STRENGTH and DURABILITY TESTS

Prove di sicurezza, resistenza e durata  
EN 1728:2012+AC2013  
EN 16139:2013 level 2  
(for P02123 - P02124)

### TECHNICAL DETAILS / Dettagli tecnici

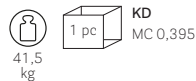
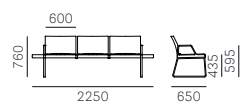

### P02124

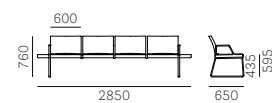

### P02126

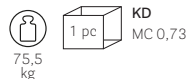
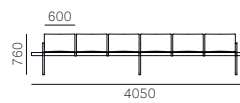

### P02129

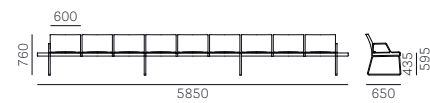

## Plus 630



SEAT Sedile	BACK Schienale	FRAME Telaio	POLYPROPYLENE Polipropilene
PPL	PPL	PPL	€ 87,00

PPL FINISHES / Finiture PPL



**SAFETY, STRENGTH and DURABILITY TESTS**  
Prove di sicurezza, resistenza e durata  
EN 1728:2000

PACKING / Imballo



TECHNICAL DETAILS / Dettagli tecnici

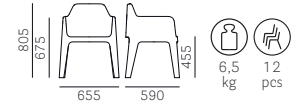

## Plus 630.3

Cushion only  
Solo cuscino



SEAT Sedile	FABRIC Tessuto
D22+D26 D80+D89 D100+D105 D110+D115 D130+D133	€ 108,00

For fabrics see page 367  
Per i tessuti si veda a p. 367

PACKING / Imballo



TECHNICAL DETAILS / Dettagli tecnici

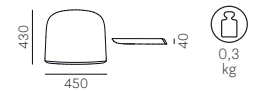

## Plus Air 631

LOUNGE



SEAT Sedile	BACK Schienale	FRAME Telaio	POLYETHYLENE Polietilene
PET	PET	PET	€ 265,00

PET FINISHES / Finiture PET

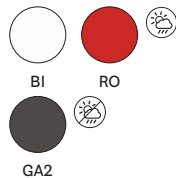

**SAFETY, STRENGTH and DURABILITY TESTS**  
Prove di sicurezza, resistenza e durata  
EN 1728:2000

PACKING / Imballo



TECHNICAL DETAILS / Dettagli tecnici

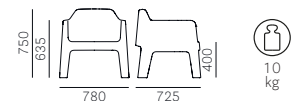

## Plus Air 631.3

Cushion only  
Solo cuscino



**SEAT**  
Sedile

D22+D26  
D80+D89  
D100+D105  
D110+D115  
D130+D133

For fabrics see page 367  
Per i tessuti si veda a p. 367

**FABRIC**  
Tessuto

€ 125,00

**PACKING / Imballo**



**TECHNICAL DETAILS / Dettagli tecnici**



## Plus Air 636

SOFA



**SEAT**  
Sedile

PET

**BACK**  
Schienale

PET

**FRAME**  
Telaio

PET

**POLYETHYLENE**  
Polietilene

€ 501,00

**PACKING / Imballo**



**TECHNICAL DETAILS / Dettagli tecnici**

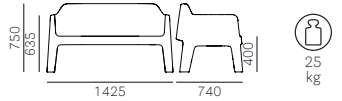

**SAFETY, STRENGTH and DURABILITY TESTS**  
Prove di sicurezza, resistenza e durata  
EN 1728:2000

**PET FINISHES / Finiture PET**

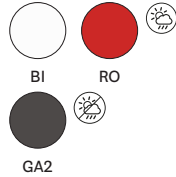

## Plus Air 636.3

Cushion only  
Solo cuscino



**SEAT**  
Sedile

D22+D26  
D80+D89  
D100+D105  
D110+D115  
D130+D133

For fabrics see page 367  
Per i tessuti si veda a p. 367

**FABRIC**  
Tessuto

€ 208,00

**PACKING / Imballo**



**TECHNICAL DETAILS / Dettagli tecnici**

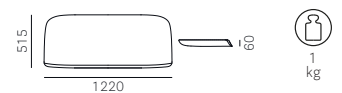



## Polar 3770

Polypropylene lumbar support  
Supporto lombare in polipropilene



SEAT Sedile	BACK Schienale	FRAME Telaio	BLACK POWDER COATED Verniciato nero	WHITE POWDER COATED Verniciato bianco
C83+C89; C100+C101 C110+C122 C210+C217	Mesh/Rete	Ø 750	€ 440,00	€ 490,00
G59+G78; G190+G197 G140+G146 G160+G169 G170+G176; G210+G213			€ 485,00	€ 535,00
H60 H120+H127			€ 450,00	€ 500,00

For fabrics see page 367  
Per i tessuti si veda a p. 367

PPL FINISHES / Finiture PPL

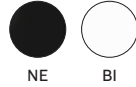

PACKING / Imballo



TECHNICAL DETAILS / Dettagli tecnici



## Polar 3771

Upholstered lumbar support  
Supporto lombare imbottito



SEAT Sedile	BACK Schienale	FRAME Telaio	BLACK POWDER COATED Verniciato nero	WHITE POWDER COATED Verniciato bianco
C83+C89; C100+C101 C110+C122 C210+C217	Mesh/Rete	Ø 750	€ 500,00	€ 550,00
G59+G78; G190+G197 G140+G146 G160+G169 G170+G176; G210+G213			€ 560,00	€ 610,00
H60 H120+H127			€ 510,00	€ 560,00

For fabrics see page 367  
Per i tessuti si veda a p. 367

PACKING / Imballo



TECHNICAL DETAILS / Dettagli tecnici



## Polar 3775

Polypropylene lumbar support  
Supporto lombare in polipropilene



SEAT Sedile	BACK Schienale	FRAME Telaio	BLACK POWDER COATED Verniciato nero	WHITE POWDER COATED Verniciato bianco
C83+C89; C100+C101 C110+C122 C210+C217	Mesh/Rete	Ø 750	€ 500,00	€ 560,00
G59+G78; G190+G197 G140+G146 G160+G169 G170+G176; G210+G213			€ 545,00	€ 605,00
H60 H120+H127			€ 510,00	€ 570,00

For fabrics see page 367  
Per i tessuti si veda a p. 367

PPL FINISHES / Finiture PPL

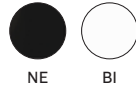

PACKING / Imballo



TECHNICAL DETAILS / Dettagli tecnici



SAFETY, STRENGTH and DURABILITY TESTS  
Prove di sicurezza, resistenza e durata  
EN 1728:2012+AC2013  
EN 1335-2:2018  
ANSI-BIFMA X5.1-2017

## Polar 3776

Upholstered lumbar support  
Supporto lombare imbottito



SEAT Sedile	BACK Schienale	FRAME Telaio	BLACK POWDER COATED Verniciato nero	WHITE POWDER COATED Verniciato bianco
C83+C89; C100+C101 C110+C122 C210+C217	Mesh/Rete	Ø 750	€ 560,00	€ 620,00
G59+G78; G190+G197 G140+G146 G160+G169 G170+G176; G210+G213			€ 620,00	€ 680,00
H60 H120+H127			€ 570,00	€ 630,00

For fabrics see page 367  
Per i tessuti si veda a p. 367

### PACKING / Imballo



### TECHNICAL DETAILS / Dettagli tecnici



**SAFETY, STRENGTH and DURABILITY TESTS**  
Prove di sicurezza, resistenza e durata  
EN 1728:2012+AC2013  
EN 1335-2:2018  
ANSI-BIFMA X5.1-2017

## Queen 650



SEAT Sedile	BACK Schienale	FRAME Telaio	POLYCARBONATE Policarbonato
PC	PC	PC	<b>€ 94,00</b>

PC FINISHES / Finiture PC

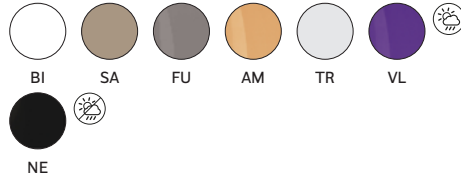

PACKING / Imballo



TECHNICAL DETAILS / Dettagli tecnici

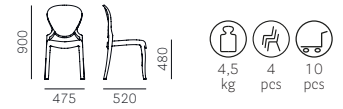

SAFETY, STRENGTH and DURABILITY TESTS  
Prove di sicurezza, resistenza e durata  
EN 1728:2000

## Queen 650/CL1

Fire retardant version  
Versione ignifuga



SEAT Sedile	BACK Schienale	FRAME Telaio	POLYCARBONATE Policarbonato
PC	PC	PC	<b>€ 104,00</b>

PC FINISHES / Finiture PC



PACKING / Imballo



TECHNICAL DETAILS / Dettagli tecnici

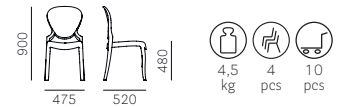

SAFETY, STRENGTH and DURABILITY TESTS  
Prove di sicurezza, resistenza e durata  
EN 1728:2000

## Queen 650.3

Cushion only  
Solo cuscino



SEAT Sedile	FABRIC Tessuto
C36÷C39 fabric / tessuto	<b>€ 105,00</b>
E velvet / velluto	<b>€ 145,00</b>
G07 fabric / tessuto	<b>€ 135,00</b>
H40÷H53 velvet / velluto	<b>€ 102,00</b>
TC *	<b>€ 84,00</b>

surcharge for pattern fabrics: + € 10,00  
supplemento per tessuti fantasia: + € 10,00

\*TC = Minimum order 20 pcs each fabric colour  
TC = Ordine minimo 20 pz per colore/tessuto

For fabrics see page 367  
Per i tessuti si veda a p. 367

PACKING / Imballo



FABRIC REQUIRED / Fabbisogno tessuto  
1 pc: Lin Mtrs 0,50 (h 1,40)

TECHNICAL DETAILS / Dettagli tecnici

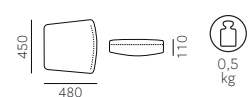

## Queen 650.8

Fabric covering only  
Solo vestina



SEAT Sedile	BACK Schienale	FRAME Telaio	FABRIC Tessuto
A10	A10	A10	€ 171,00

COVERING FINISHES / Finiture vestina



A10

RIM FINISHES / Finiture bordino



A10

PACKING / Imballo



MC 0,056

TECHNICAL DETAILS / Dettagli tecnici

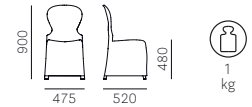

## Remind 3730RM



recycled polypropylene



SEAT Sedile	BACK Schienale	FRAME Telaio	POLYPROPYLENE Polipropilene
PPL	PPL	PPL	€ 75,00

PPL FINISHES / Finiture PPL



RG

PACKING / Imballo



MC 0,345

TECHNICAL DETAILS / Dettagli tecnici

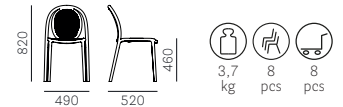

SAFETY, STRENGTH and DURABILITY TESTS  
Prove di sicurezza, resistenza e durata  
EN 1728:2012+AC2013  
EN 16139:2013 level 2



## Remind 3730



SEAT Sedile	BACK Schienale	FRAME Telaio	POLYPROPYLENE Polipropilene
PPL	PPL	PPL	€ 75,00

PPL FINISHES / Finiture PPL



NE

BE

SA

RO

VE

TE

PACKING / Imballo



MC 0,345

TECHNICAL DETAILS / Dettagli tecnici

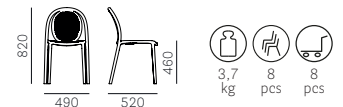

SAFETY, STRENGTH and DURABILITY TESTS  
Prove di sicurezza, resistenza e durata  
EN 1728:2012+AC2013  
EN 16139:2013 level 2



## Remind 3735RM



recycled polypropylene

SEAT Sedile	BACK Schienale	FRAME Telaio	POLYPROPYLENE Polipropilene
PPL	PPL	PPL	€ 91,00

### PPL FINISHES / Finiture PPL



RG

### PACKING / Imballo



MC 0,405

### TECHNICAL DETAILS / Dettagli tecnici

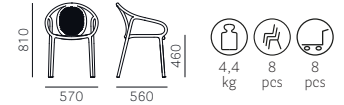

**SAFETY, STRENGTH and DURABILITY TESTS**  
 Prove di sicurezza, resistenza e durata  
 EN 1728:2012+AC2013  
 EN 16139:2013 level 2  
 ANSI-BIFMA X5.1-2017



## Remind 3735



SEAT Sedile	BACK Schienale	FRAME Telaio	POLYPROPYLENE Polipropilene
PPL	PPL	PPL	€ 91,00

### PPL FINISHES / Finiture PPL



NE

BE

SA

RO

VE

TE

### PACKING / Imballo



MC 0,405

### TECHNICAL DETAILS / Dettagli tecnici

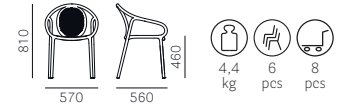

**SAFETY, STRENGTH and DURABILITY TESTS**  
 Prove di sicurezza, resistenza e durata  
 EN 1728:2012+AC2013  
 EN 16139:2013 level 2  
 ANSI-BIFMA X5.1-2017



## Remind pixel



SEAT Sedile	BACK Schienale	FRAME Telaio	POLYPROPYLENE Polipropilene
PPL	PPL	PPL	€ 88,00 Pack of 300 pixels Confezione da 300 pixel

### PPL FINISHES / Finiture PPL



RO

RA



CODE Codice	SEAT Sedile	BACK Schienale	FRAME Telaio	POWDER COATED Verniciato
<b>RAIL</b> Sun lounger Lettino	TXT	TXT	BI100E, SA200E + TXT	<b>€ 735,00</b>
RAIL + RAIL.23				<b>€ 1.105,00</b>
<b>RAIL/2</b> Sun lounger with rear castors Lettino con ruote posteriori	TXT	TXT	BI100E, SA200E + TXT	<b>€ 830,00</b>
RAIL/2 + RAIL.23				<b>€ 1.200,00</b>
<b>RAIL.23</b> Cushion for sun lounger Cuscino per lettino	D22+D26 D80+D89 D100+D105 D110+D115 D130+D133	D22+D26 D80+D89 D100+D105 D110+D115 D130+D133		<b>€ 370,00</b>
<b>RAIL.30</b> Sun lounger roof Tettuccio parasole			BI100E, SA200E + TXT	<b>€ 158,00</b>

### TXT FINISHES / Finiture TXT

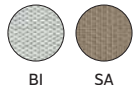

BI SA

### POWDER COATED FINISHES / Finiture verniciato



BI100E SA200E

For fabrics see page 367  
Per i tessuti si veda a p. 367

### SAFETY, STRENGTH and DURABILITY TESTS

Prove di sicurezza, resistenza e durata  
EN 1728:2012+AC2013  
EN 581-2:2015

### TECHNICAL DETAILS / Dettagli tecnici

#### RAIL



#### RAIL/2



#### RAIL.23



#### RAIL.30



## Reva



CODE Codice	SEAT Sedile	BACK Schienale	FRAME Telaio	POWDER COATED Verniciato	FABRIC Tessuto
<b>REVA_D</b> Three seater sofa Divano a tre posti	D22+D26 D80+D89 D100+D105 D110+D115 D130+D133	D22+D26 D80+D89 D100+D105 D110+D115 D130+D133	BI100E, SA200E + TXT	<b>€ 2.008,00</b>	
REVA_D + 3005 (2pcs)				<b>€ 2.158,00</b>	
<b>REVA_P</b> Armchair Poltrona	D22+D26 D80+D89 D100+D105 D110+D115 D130+D133	D22+D26 D80+D89 D100+D105 D110+D115 D130+D133	BI100E, SA200E + TXT	<b>€ 1.217,00</b>	
REVA_P + 3005 (2pcs)				<b>€ 1.367,00</b>	
<b>3005</b> Optional side pillow Cuscino laterale opzionale	D22+D26 D80+D89 D100+D105 D110+D115 D130+D133	D22+D26 D80+D89 D100+D105 D110+D115 D130+D133			<b>€ 75,00</b> (1 pc / 1 pz)
<b>3005.1</b> Pillowcase for lateral cushion Federa cuscino laterale	D22+D26 D80+D89 D100+D105 D110+D115 D130+D133	D22+D26 D80+D89 D100+D105 D110+D115 D130+D133			<b>€ 47,00</b> (1 pc / 1 pz)
<b>REVA.17</b> Pillowcase for seat cushion Federa cuscino sedile	D22+D26 D80+D89 D100+D105 D110+D115 D130+D133				<b>€ 149,00</b> (1 pc / 1 pz)
<b>REVA.18</b> Pillowcase for backrest cushion Federa cuscino schienale		D22+D26 D80+D89 D100+D105 D110+D115 D130+D133			<b>€ 103,00</b> (1 pc / 1 pz)
<b>REVA_L</b> Sun lounger Lettino			BI100E, SA200E + TXT	<b>€ 1.155,00</b>	
REVA_L + REVA_L.3				<b>€ 1.606,00</b>	
<b>REVA_L.3*</b> Cushion for sun lounger Cuscino per lettino	D22+D26 D80+D89 D100+D105 D110+D115 D130+D133	D22+D26 D80+D89 D100+D105 D110+D115 D130+D133			<b>€ 451,00</b>
<b>RAIL.30</b> Sun lounger roof Tettuccio parasole			BI100E, SA200E + TXT	<b>€ 158,00</b>	

\*In case of combination with the sun lounger roof (item RAIL.30) supply the RAIL sun lounger cushion (item RAIL.23)  
In caso di abbinamento con il tettuccio parasole (art. RAIL.30) fornire il cuscino per lettino del RAIL (art. RAIL.23)

Optional cushions available on request see page 344  
Disponibili a richiesta i cuscini accessori si veda a p. 344

Optional protective covers available on request see page 346  
Disponibili a richiesta le coperture protettive accessorie si veda a p. 346

**TXT FINISHES (sofa and armchair)**  
Finiture TXT (divano e poltrona)

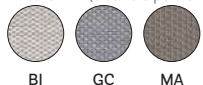

**POWDER COATED FINISHES**  
Finiture verniciato



**TXT FINISHES (sun lounger)**  
Finiture TXT (lettino)

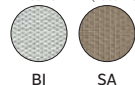

For fabrics see page 367  
Per i tessuti si veda a p. 367

**SAFETY, STRENGTH and DURABILITY TESTS**

Prove di sicurezza, resistenza e durata  
EN 1728:2012+AC2013  
EN 16139:2013 level 2  
(for REVA\_L)  
EN 1728:2012+AC2013  
EN 581-1:2017  
EN 581-2:2015+AC2013  
(for REVA\_D)

**TECHNICAL DETAILS / Dettagli tecnici**  
**REVA\_D**

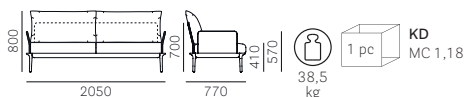

**REVA\_P**

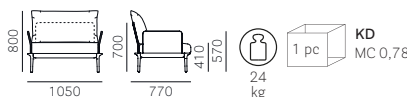

**3005**

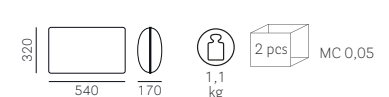

**REVA\_L**

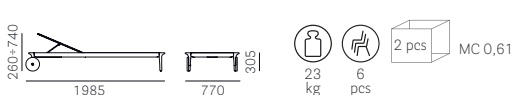

**REVA\_L.3**

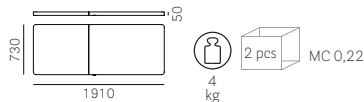

**RAIL.30**



## Reva Twist



CODE Codice	SEAT Sedile	BACK Schienale	FRAME Telaio	POWDER COATED Verniciato	FABRIC Tessuto
<b>REVA/2_D</b> Three seater sofa Divano a tre posti	D22+D26 D80+D89 D100+D105 D110+D115 D130+D133	D22+D26 D80+D89 D100+D105 D110+D115 D130+D133	Powder coated / Verniciato + Cord / Corda	<b>€ 2.300,00</b>	
REVA/2_D + 3005 (2pcs)				<b>€ 2.450,00</b>	
<b>REVA/2_P</b> Armchair Poltrona	D22+D26 D80+D89 D100+D105 D110+D115 D130+D133	D22+D26 D80+D89 D100+D105 D110+D115 D130+D133	Powder coated / Verniciato + Cord / Corda	<b>€ 1.500,00</b>	
REVA/2_P + 3005 (2pcs)				<b>€ 1.650,00</b>	
<b>3005</b> Optional side pillow Cuscino laterale opzionale	D22+D26 D80+D89 D100+D105 D110+D115 D130+D133	D22+D26 D80+D89 D100+D105 D110+D115 D130+D133			<b>€ 75,00</b> (1 pc / 1 pz)
<b>3005.1</b> Pillowcase for lateral cushion Federa cuscino laterale	D22+D26 D80+D89 D100+D105 D110+D115 D130+D133	D22+D26 D80+D89 D100+D105 D110+D115 D130+D133			<b>€ 47,00</b> (1 pc / 1 pz)
<b>REVA.17</b> Pillowcase for seat cushion Federa cuscino sedile	D22+D26 D80+D89 D100+D105 D110+D115 D130+D133				<b>€ 149,00</b> (1 pc / 1 pz)
<b>REVA.18</b> Pillowcase for backrest cushion Federa cuscino schienale		D22+D26 D80+D89 D100+D105 D110+D115 D130+D133			<b>€ 103,00</b> (1 pc / 1 pz)

Optional cushions available on request see page 344  
Disponibili a richiesta i cuscini accessori si veda a p. 344

Optional protective covers available on request see page 346  
Disponibili a richiesta le coperture protettive accessorie si veda a p. 346

### CORD FINISHES

Finiture corda



BE

MA2

TE

### POWDER COATED FINISHES

Finiture verniciato



BI100E

BE100E

SA200E

MGE

TEE

For fabrics see page 367  
Per i tessuti si veda a p. 367

### SAFETY, STRENGTH and DURABILITY TESTS

Prove di sicurezza, resistenza e durata

EN 1728:2012+AC2013  
EN 581-1:2017  
EN 581-2:2015+AC2013  
(for REVA/2\_D)

### TECHNICAL DETAILS / Dettagli tecnici

#### REVA/2\_D

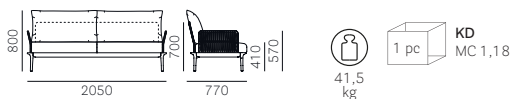

#### 3005



#### REVA/2\_P





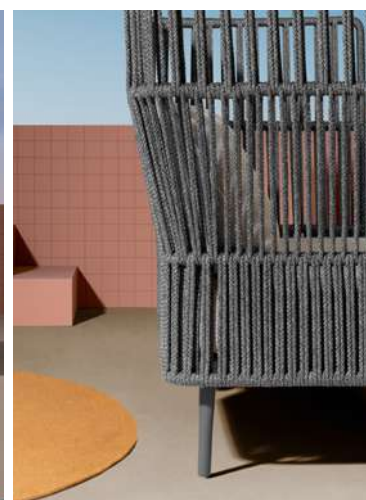

CODE Codice	SEAT Sedile	BACK Schienale	FRAME Telaio	POWDER COATED Verniciato
<b>RVC010</b> Pouf	D22+D26 D80+D89 D100+D105 D110+D115 D130+D133	D22+D26 D80+D89 D100+D105 D110+D115 D130+D133	Powder coated / Verniciato	<b>€ 1.335,00</b>
<b>RVC011</b> Linear armchair with high backrest Poltrona lineare con schienale alto	D22+D26 D80+D89 D100+D105 D110+D115 D130+D133	D22+D26 D80+D89 D100+D105 D110+D115 D130+D133	Powder coated / Verniciato + Cord / Corda	<b>€ 2.060,00</b>
<b>RVC012</b> Linear armchair with low backrest Poltrona lineare con schienale basso				<b>€ 1.780,00</b>
<b>RVC013</b> Right corner armchair Poltrona angolare DX	D22+D26 D80+D89 D100+D105 D110+D115 D130+D133	D22+D26 D80+D89 D100+D105 D110+D115 D130+D133	Powder coated / Verniciato + Cord / Corda	<b>€ 3.135,00</b>
<b>RVC014</b> Left corner armchair Poltrona angolare SX				
<b>RVC021</b> Linear sofa with high backrest Divano lineare con schienale alto	D22+D26 D80+D89 D100+D105 D110+D115 D130+D133	D22+D26 D80+D89 D100+D105 D110+D115 D130+D133	Powder coated / Verniciato + Cord / Corda	<b>€ 4.165,00</b>
<b>RVC022</b> Linear sofa with low backrest Divano lineare con schienale basso				<b>€ 3.605,00</b>
<b>RVC023</b> Right corner and linear sofa with high backrest Divano angolare DX e lineare con schienale alto	D22+D26 D80+D89 D100+D105 D110+D115 D130+D133	D22+D26 D80+D89 D100+D105 D110+D115 D130+D133	Powder coated / Verniciato + Cord / Corda	<b>€ 5.040,00</b>
<b>RVC024</b> Left corner and linear sofa with high backrest Divano angolare SX e lineare con schienale alto				
<b>RVC025</b> Right corner and linear sofa with low backrest Divano angolare DX e lineare con schienale basso	D22+D26 D80+D89 D100+D105 D110+D115 D130+D133	D22+D26 D80+D89 D100+D105 D110+D115 D130+D133	Powder coated / Verniciato + Cord / Corda	<b>€ 4.760,00</b>
<b>RVC026</b> Left corner and linear sofa with low backrest Divano angolare SX e lineare con schienale basso				
<b>RVC027</b> Right and left corner sofa Divano angolare DX e SX	D22+D26 D80+D89 D100+D105 D110+D115 D130+D133	D22+D26 D80+D89 D100+D105 D110+D115 D130+D133	Powder coated / Verniciato + Cord / Corda	<b>€ 5.915,00</b>
<b>RVC033</b> Right chaise longue Chaise longue angolare DX	D22+D26 D80+D89 D100+D105 D110+D115 D130+D133	D22+D26 D80+D89 D100+D105 D110+D115 D130+D133	Powder coated / Verniciato + Cord / Corda	<b>€ 3.425,00</b>
<b>RVC034</b> Left chaise longue Chaise longue angolare SX				

Optional cushions available on request see page 344  
Disponibili a richiesta i cuscini accessori si veda a p. 344

Optional protective covers available on request see page 346  
Disponibili a richiesta le coperture protettive accessorie si veda a p. 346

## CORD FINISHES Finiture corda



BE GA2 TE

## POWDER COATED FINISHES Finiture verniciato

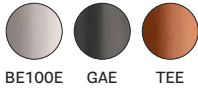

BE100E GAE TEE

For fabrics see page 367  
Per i tessuti si veda a p. 367

## TECHNICAL DETAILS / Dettagli tecnici RVC010



## RVC011

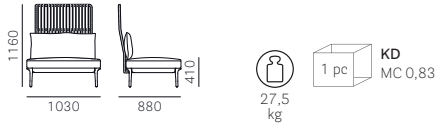

## RVC012



## RVC013

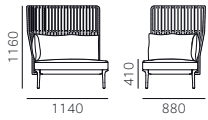

## RVC014

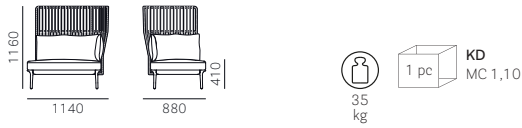

## RVC021

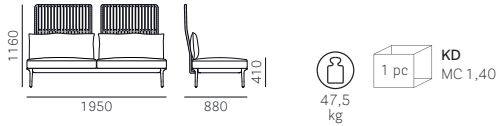

## RVC022



## RVC023

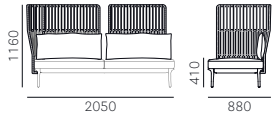

## RVC024



## RVC025

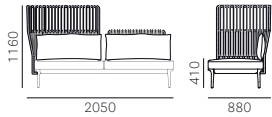

## RVC026



## RVC027

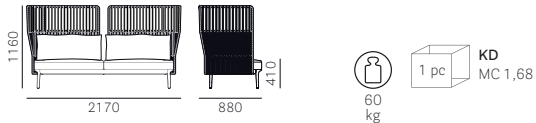

## RVC033

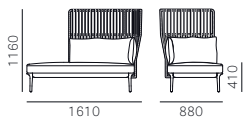

## RVC034



# Rubik 580



SEAT Sedile	FRAME Telaio	POLYCARBONATE Policarbonato
PC	PC H750	€ 88,00

**SAFETY, STRENGTH and DURABILITY TESTS**  
 Prove di sicurezza, resistenza e durata  
 EN 15373:2007

PC FINISHES / Finiture PC

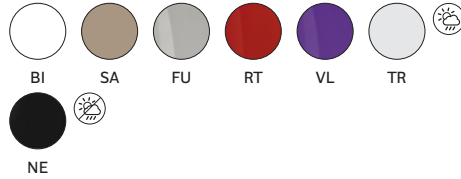

PACKING / Imballo



TECHNICAL DETAILS / Dettagli tecnici

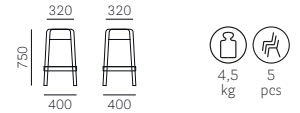

# Rubik 580/CL1

Fire retardant version  
 Versione ignifuga



SEAT Sedile	FRAME Telaio	POLYCARBONATE Policarbonato
PC	PC H750	€ 102,00

Minimum order 300 pcs each colour  
 Ordine minimo 300 pz per colore

**SAFETY, STRENGTH and DURABILITY TESTS**  
 Prove di sicurezza, resistenza e durata  
 EN 15373:2007

PC FINISHES / Finiture PC

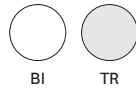

PACKING / Imballo



TECHNICAL DETAILS / Dettagli tecnici

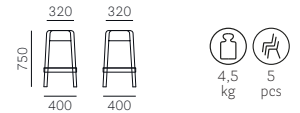

# Rubik 582



SEAT Sedile	FRAME Telaio	POLYCARBONATE Policarbonato
PC	PC H650	€ 109,00

**SAFETY, STRENGTH and DURABILITY TESTS**  
 Prove di sicurezza, resistenza e durata  
 EN 15373:2007

PC FINISHES / Finiture PC

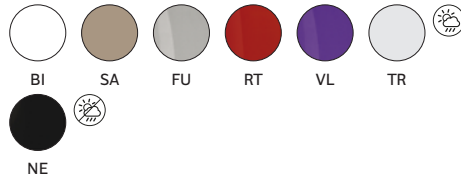

PACKING / Imballo



TECHNICAL DETAILS / Dettagli tecnici

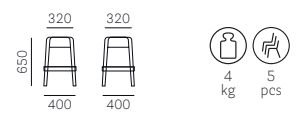

# Rubik 583



SEAT Sedile	FRAME Telaio	POLYCARBONATE Policarbonato
PC	PC H450	<b>€ 109,00</b>

PC FINISHES / Finiture PC



PACKING / Imballo



TECHNICAL DETAILS / Dettagli tecnici



# Serif 860



SEAT Sedile	FRAME Telaio	POLYETHYLENE Polietilene
PET	PET H750	<b>€ 155,00</b>

PET FINISHES / Finiture PET

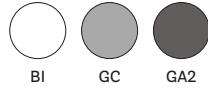

PACKING / Imballo



TECHNICAL DETAILS / Dettagli tecnici

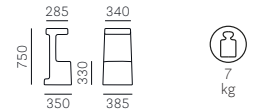

SAFETY, STRENGTH and DURABILITY TESTS  
 Prove di sicurezza, resistenza e durata  
 EN 1728:2000

## Sign 455



SEAT Sedile	BACK Schienale	FRAME Telaio
A		
C*		
D120+D123	RS-W-N1- GC-BI	RS-W-N1- GC-BI
G		
H		
P*	TC	TC
TC**		
CL**		

\*\*TC/CL = Minimum order 10 pcs each fabric colour  
TC/CL = Ordine minimo 10 pz per colore/tessuto

\*Excluding / Escluso C36+C39, PBS-PCO-PMS-PVE

### FINISHES / Finiture



### OAK Rovere

€ 335,00  
€ 346,00  
€ 367,00  
€ 375,00  
€ 350,00  
€ 380,00  
€ 335,00  
€ 341,00

### OAK STAINED ON SAMPLE Rovere tinto campione

€ 359,00  
€ 370,00  
€ 390,00  
€ 398,00  
€ 373,00  
€ 403,00  
€ 359,00  
€ 364,00

Minimum order q.ty: 20 pcs  
Ordine minimo: 20pz

For fabrics see page 367  
Per i tessuti si veda a p. 367

### PACKING / Imballo



FABRIC REQUIRED / Fabbisogno tessuto  
1pc: Lin Mtrs 0,80 (h 1,40)

### TECHNICAL DETAILS / Dettagli tecnici

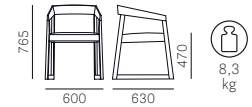

## Sign 457



SEAT Sedile	BACK Schienale	FRAME Telaio
A	A	
C*	C*	
D120+D123	D120+D123	RS-W-N1- GC-BI
G	G	
H	H	
P*	P*	TC
TC**	TC**	
CL**	CL**	

\*\*TC/CL = Minimum order 10 pcs each fabric colour  
TC/CL = Ordine minimo 10 pz per colore/tessuto

\*Excluding / Escluso C36+C39, PBS-PCO-PMS-PVE

### FINISHES / Finiture



### OAK Rovere

€ 451,00  
€ 473,00  
€ 509,00  
€ 535,00  
€ 480,00  
€ 552,00  
€ 451,00  
€ 457,00

### OAK STAINED ON SAMPLE Rovere tinto campione

€ 474,00  
€ 496,00  
€ 532,00  
€ 559,00  
€ 503,00  
€ 575,00  
€ 474,00  
€ 480,00

Minimum order q.ty: 20 pcs  
Ordine minimo: 20pz

For fabrics see page 367  
Per i tessuti si veda a p. 367

### PACKING / Imballo



FABRIC REQUIRED / Fabbisogno tessuto  
1pc: Lin Mtrs 1,40 (h 1,40)

### TECHNICAL DETAILS / Dettagli tecnici

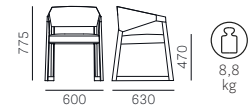

## Snow 300



SEAT Sedile	BACK Schienale	FRAME Telaio	POLYPROPYLENE Polipropilene
PPL	PPL	PPL	€ 57,00

### PPL FINISHES / Finiture PPL

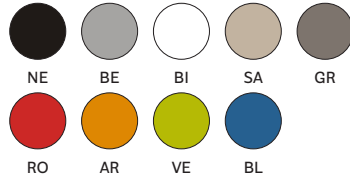

**SAFETY, STRENGTH and DURABILITY TESTS**  
 Prove di sicurezza, resistenza e durata  
 EN 1728:2012+AC2013  
 ANSI-BIFMA X5.1-2017  
 EN 16139:2013 level 2

### PACKING / Imballo



### TECHNICAL DETAILS / Dettagli tecnici

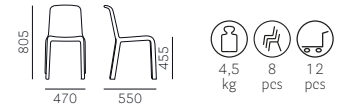

## Snow 300/CL1

Fire retardant version  
 Versione ignifuga



SEAT Sedile	BACK Schienale	FRAME Telaio	POLYPROPYLENE Polipropilene
PPL	PPL	PPL	€ 81,00

Minimum order 300 pcs  
 Ordine minimo 300 pz

### PPL FINISHES / Finiture PPL



**SAFETY, STRENGTH and DURABILITY TESTS**  
 Prove di sicurezza, resistenza e durata  
 EN 1728:2012+AC2013  
 ANSI-BIFMA X5.1-2017  
 EN 16139:2013 level 2

### PACKING / Imballo



### TECHNICAL DETAILS / Dettagli tecnici

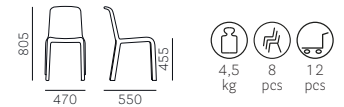

## Snow 303

JUNIOR



SEAT Sedile	BACK Schienale	FRAME Telaio	POLYPROPYLENE Polipropilene
PPL	PPL	PPL	€ 48,00

### PPL FINISHES / Finiture PPL



### PACKING / Imballo



### TECHNICAL DETAILS / Dettagli tecnici



## Social

Two seats  
Due sedute



### SAFETY, STRENGTH and DURABILITY TESTS

Prove di sicurezza, resistenza e durata  
EN 1728:2012+AC2013  
EN 16139:2013 level 2

CODE Codice	SEAT Sedile	BACK Schienale	POWDER COATED Verniciato	POLISHED ALUMINIUM Alluminio lucidato
DSO_2L	A	A	€ 1.066,00	€ 1.094,00
	C*	C*	€ 1.137,00	€ 1.165,00
	D40÷D44	D40÷D44	€ 1.222,00	€ 1.249,00
	D120÷D123	D120÷D123	€ 1.436,00	€ 1.464,00
	E	E	€ 1.351,00	€ 1.379,00
	G	G	€ 1.167,00	€ 1.195,00
	H	H	€ 1.412,00	€ 1.440,00
	N*	N*	€ 1.671,00	€ 1.698,00
	P*	P*	€ 1.066,00	€ 1.094,00
TC**	TC**	€ 1.066,00	€ 1.094,00	
**TC = Minimum order 10 pcs each fabric colour (single seat unit) / Ordine minimo 10 pz per colore/tessuto (sedute singole)				
DSO_2LP	A	A	€ 962,00	€ 990,00
	C*	C*	€ 1.027,00	€ 1.056,00
	D40÷D44	D40÷D44	€ 1.105,00	€ 1.134,00
	D120÷D123	D120÷D123	€ 1.304,00	€ 1.331,00
	E	E	€ 1.224,00	€ 1.252,00
	G	G	€ 1.055,00	€ 1.083,00
	H	H	€ 1.279,00	€ 1.308,00
	N*	N*	€ 1.528,00	€ 1.556,00
	P*	P*	€ 962,00	€ 990,00
TC**	TC**	€ 962,00	€ 990,00	
**TC = Minimum order 10 pcs each fabric colour (single seat unit) / Ordine minimo 10 pz per colore/tessuto (sedute singole)				
DSO_2AL	A	A	€ 1.246,00	€ 1.274,00
	C*	C*	€ 1.336,00	€ 1.363,00
	D40÷D44	D40÷D44	€ 1.441,00	€ 1.469,00
	D120÷D123	D120÷D123	€ 1.706,00	€ 1.733,00
	E	E	€ 1.588,00	€ 1.615,00
	G	G	€ 1.373,00	€ 1.401,00
	H	H	€ 1.679,00	€ 1.707,00
	N*	N*	€ 1.977,00	€ 2.006,00
	P*	P*	€ 1.246,00	€ 1.274,00
TC**	TC**	€ 1.246,00	€ 1.274,00	
**TC = Minimum order 10 pcs each fabric colour (single seat unit) / Ordine minimo 10 pz per colore/tessuto (sedute singole)				
DSO_2A	A	A	€ 1.426,00	€ 1.454,00
	C*	C*	€ 1.535,00	€ 1.562,00
	D40÷D44	D40÷D44	€ 1.661,00	€ 1.689,00
	D120÷D123	D120÷D123	€ 1.974,00	€ 2.002,00
	E	E	€ 1.824,00	€ 1.852,00
	G	G	€ 1.579,00	€ 1.606,00
	H	H	€ 1.946,00	€ 1.974,00
	N*	N*	€ 2.284,00	€ 2.313,00
	P*	P*	€ 1.426,00	€ 1.454,00
TC**	TC**	€ 1.426,00	€ 1.454,00	
**TC = Minimum order 10 pcs each fabric colour (single seat unit) / Ordine minimo 10 pz per colore/tessuto (sedute singole)				
DSO_2P	A	A	€ 858,00	€ 887,00
	C*	C*	€ 918,00	€ 947,00
	D40÷D44	D40÷D44	€ 988,00	€ 1.017,00
	D120÷D123	D120÷D123	€ 1.171,00	€ 1.199,00
	E	E	€ 1.097,00	€ 1.125,00
	G	G	€ 943,00	€ 971,00
	H	H	€ 1.147,00	€ 1.175,00
	N*	N*	€ 1.384,00	€ 1.412,00
	P*	P*	€ 858,00	€ 887,00
TC**	TC**	€ 858,00	€ 887,00	
**TC = Minimum order 10 pcs each fabric colour (single seat unit) / Ordine minimo 10 pz per colore/tessuto (sedute singole)				
DSO_LINK	Connecting plate kit for DSO sofas: surcharge € 24,00 Kit lamiera di collegamento per divani DSO: supplemento € 24,00			

\* Excluding / Escluso C36+C39, N20+N27, PBS-PCO-PMS-PVE

For fabrics see page 367  
Per i tessuti si veda a p. 367

For colours and finishes see at page 362  
Per colori e finiture vedere da pagina 362

### TECHNICAL DETAILS / Dettagli tecnici

#### DSO\_2L

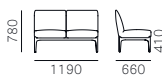

1 pc KD  
MC 0,31

FABRIC REQUIRED /  
Fabbisogno tessuto  
1pc: Lin Mtrs 2,40 (h 1,40)

#### DSO\_2LP

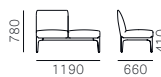

1 pc KD  
MC 0,58

FABRIC REQUIRED /  
Fabbisogno tessuto  
1pc: Lin Mtrs 3,00 (h 1,40)

#### DSO\_2AL



1 pc KD  
MC 0,58

FABRIC REQUIRED /  
Fabbisogno tessuto  
1pc: Lin Mtrs 3,55 (h 1,40)

#### DSO\_2A



1 pc KD  
MC 0,31

FABRIC REQUIRED /  
Fabbisogno tessuto  
1pc: Lin Mtrs 3,15 (h 1,40)

#### DSO\_2P

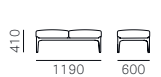

1 pc KD  
MC 0,31

FABRIC REQUIRED /  
Fabbisogno tessuto  
1pc: Lin Mtrs 2,35 (h 1,40)

## Social

Three seats  
Tre sedute



### SAFETY, STRENGTH and DURABILITY TESTS

Prove di sicurezza, resistenza e durata

EN 1728:2012+AC2013

EN 16139:2013 level 2

CODE Codice	SEAT Sedile	BACK Schienale	POWDER COATED Verniciato	POLISHED ALUMINIUM Alluminio lucidato
DSO_3L	A	A	€ 1.542,00	€ 1.570,00
	C*	C*	€ 1.650,00	€ 1.679,00
	D40÷D44	D40÷D44	€ 1.777,00	€ 1.805,00
	D120÷D123	D120÷D123	€ 2.099,00	€ 2.127,00
	E	E	€ 1.971,00	€ 1.999,00
	G	G	€ 1.695,00	€ 1.723,00
	H	H	€ 2.062,00	€ 2.090,00
	N*	N*	€ 2.451,00	€ 2.478,00
	P*	P*	€ 1.542,00	€ 1.570,00
	TC**	TC**		
**TC = Minimum order 10 pcs each fabric colour (single seat unit) / Ordine minimo 10 pz per colore/tessuto (sedute singole)				
DSO_3LLP	A	A	€ 1.438,00	€ 1.467,00
	C*	C*	€ 1.540,00	€ 1.569,00
	D40÷D44	D40÷D44	€ 1.661,00	€ 1.688,00
	D120÷D123	D120÷D123	€ 1.967,00	€ 1.994,00
	E	E	€ 1.844,00	€ 1.872,00
	G	G	€ 1.583,00	€ 1.611,00
	H	H	€ 1.929,00	€ 1.958,00
	N*	N*	€ 2.307,00	€ 2.335,00
	P*	P*	€ 1.438,00	€ 1.467,00
	TC**	TC**		
**TC = Minimum order 10 pcs each fabric colour (single seat unit) / Ordine minimo 10 pz per colore/tessuto (sedute singole)				
DSO_3ALL	A	A	€ 1.723,00	€ 1.750,00
	C*	C*	€ 1.848,00	€ 1.876,00
	D40÷D44	D40÷D44	€ 1.997,00	€ 2.024,00
	D120÷D123	D120÷D123	€ 2.368,00	€ 2.396,00
	E	E	€ 2.208,00	€ 2.235,00
	G	G	€ 1.900,00	€ 1.928,00
	H	H	€ 2.329,00	€ 2.358,00
	N*	N*	€ 2.758,00	€ 2.786,00
	P*	P*	€ 1.723,00	€ 1.750,00
	TC**	TC**		
**TC = Minimum order 10 pcs each fabric colour (single seat unit) / Ordine minimo 10 pz per colore/tessuto (sedute singole)				
DSO_3AAL	A	A	€ 1.903,00	€ 1.931,00
	C*	C*	€ 2.047,00	€ 2.075,00
	D40÷D44	D40÷D44	€ 2.216,00	€ 2.244,00
	D120÷D123	D120÷D123	€ 2.638,00	€ 2.665,00
	E	E	€ 2.445,00	€ 2.472,00
	G	G	€ 2.106,00	€ 2.134,00
	H	H	€ 2.596,00	€ 2.625,00
	N*	N*	€ 3.064,00	€ 3.093,00
	P*	P*	€ 1.903,00	€ 1.931,00
	TC**	TC**		
**TC = Minimum order 10 pcs each fabric colour (single seat unit) / Ordine minimo 10 pz per colore/tessuto (sedute singole)				
DSO_3ALP	A	A	€ 1.619,00	€ 1.646,00
	C*	C*	€ 1.739,00	€ 1.767,00
	D40÷D44	D40÷D44	€ 1.880,00	€ 1.908,00
	D120÷D123	D120÷D123	€ 2.235,00	€ 2.263,00
	E	E	€ 2.081,00	€ 2.108,00
	G	G	€ 1.789,00	€ 1.816,00
	H	H	€ 2.197,00	€ 2.224,00
	N*	N*	€ 2.614,00	€ 2.642,00
	P*	P*	€ 1.619,00	€ 1.646,00
	TC**	TC**		
**TC = Minimum order 10 pcs each fabric colour (single seat unit) / Ordine minimo 10 pz per colore/tessuto (sedute singole)				
DSO_LINK	Connecting plate kit for DSO sofas: surcharge € 24,00 Kit lamiera di collegamento per divani DSO: supplemento € 24,00			

\* Excluding / Escluso C36+C39, N20+N27, PBS-PCO-PMS-PVE

For fabrics see page 367  
Per i tessuti si veda a p. 367

For colours and finishes see at page 362  
Per colori e finiture vedere da pagina 362

### TECHNICAL DETAILS / Dettagli tecnici

#### DSO\_3L

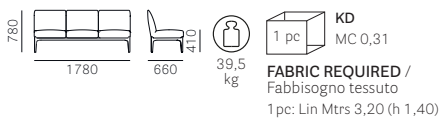

#### DSO\_3LLP



#### DSO\_3ALL



#### DSO\_3AAL



#### DSO\_3ALP





## Social

Four seats  
Quattro sedute

CODE Codice	SEAT Sedile	BACK Schienale	POWDER COATED Verniciato	POLISHED ALUMINIUM Alluminio lucidato
<b>DSO_4L</b>	A	A	€ 2.059,00	€ 2.088,00
	C*	C*	€ 2.203,00	€ 2.232,00
	D40÷D44	D40÷D44	€ 2.372,00	€ 2.401,00
	D120÷D123	D120÷D123	€ 2.801,00	€ 2.830,00
	E	E	€ 2.631,00	€ 2.660,00
	G	G	€ 2.262,00	€ 2.290,00
	H	H	€ 2.753,00	€ 2.781,00
	N*	N*	€ 3.269,00	€ 3.298,00
	P*	P*	€ 2.059,00	€ 2.088,00
	TC**	TC**		
**TC = Minimum order 10 pcs each fabric colour (single seat unit) / Ordine minimo 10 pz per colore/tessuto (sedute singole)				
<b>DSO_4ALLL</b>	A	A	€ 2.240,00	€ 2.268,00
	C*	C*	€ 2.402,00	€ 2.430,00
	D40÷D44	D40÷D44	€ 2.591,00	€ 2.620,00
	D120÷D123	D120÷D123	€ 3.071,00	€ 3.100,00
	E	E	€ 2.868,00	€ 2.895,00
	G	G	€ 2.468,00	€ 2.497,00
	H	H	€ 3.020,00	€ 3.048,00
	N*	N*	€ 3.577,00	€ 3.606,00
	P*	P*	€ 2.240,00	€ 2.268,00
	TC**	TC**		
**TC = Minimum order 10 pcs each fabric colour (single seat unit) / Ordine minimo 10 pz per colore/tessuto (sedute singole)				
<b>DSO_4AALL</b>	A	A	€ 2.420,00	€ 2.448,00
	C*	C*	€ 2.601,00	€ 2.628,00
	D40÷D44	D40÷D44	€ 2.811,00	€ 2.840,00
	D120÷D123	D120÷D123	€ 3.340,00	€ 3.369,00
	E	E	€ 3.104,00	€ 3.132,00
	G	G	€ 2.673,00	€ 2.702,00
	H	H	€ 3.286,00	€ 3.314,00
	N*	N*	€ 3.884,00	€ 3.912,00
	P*	P*	€ 2.420,00	€ 2.448,00
	TC**	TC**		
**TC = Minimum order 10 pcs each fabric colour (single seat unit) / Ordine minimo 10 pz per colore/tessuto (sedute singole)				
<b>DSO_2X2P</b>	A	A	€ 1.575,00	€ 1.603,00
	C*	C*	€ 1.695,00	€ 1.723,00
	D40÷D44	D40÷D44	€ 1.835,00	€ 1.864,00
	D120÷D123	D120÷D123	€ 2.200,00	€ 2.229,00
	E	E	€ 2.051,00	€ 2.079,00
	G	G	€ 1.743,00	€ 1.772,00
	H	H	€ 2.152,00	€ 2.180,00
	N*	N*	€ 2.627,00	€ 2.655,00
	P*	P*	€ 1.575,00	€ 1.603,00
	TC**	TC**		
**TC = Minimum order 10 pcs each fabric colour (single seat unit) / Ordine minimo 10 pz per colore/tessuto (sedute singole)				
<b>DSO_LINK</b>	Connecting plate kit for DSO sofas: surcharge € 24,00 Kit lamiera di collegamento per divani DSO: supplemento € 24,00			

\* Excluding / Escluso C36+C39, N20+N27, PBS-PCO-PMS-PVE

For fabrics see page 367  
Per i tessuti si veda a p. 367For colours and finishes see at page 362  
Per colori e finiture vedere da pagina 362

## SAFETY, STRENGTH and DURABILITY TESTS

Prove di sicurezza, resistenza e durata  
EN 1728:2012+AC2013  
EN 16139:2013 level 2

## TECHNICAL DETAILS / Dettagli tecnici

## DSO\_4L



1 pc MC 0,315

FABRIC REQUIRED /  
Fabbisogno tessuto

1pc: Lin Mtrs 4,80 (h 1,40)

## DSO\_4ALLL

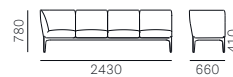

1 pc MC 0,585

FABRIC REQUIRED /  
Fabbisogno tessuto

1pc: Lin Mtrs 4,95 (h 1,40)

## DSO\_4AALL

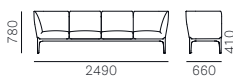

1 pc MC 0,585

FABRIC REQUIRED /  
Fabbisogno tessuto

1pc: Lin Mtrs 5,55 (h 1,40)

## DSO\_2X2P

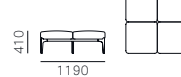



1 pc MC 0,345

FABRIC REQUIRED /  
Fabbisogno tessuto

1pc: Lin Mtrs 3,00 (h 1,40)

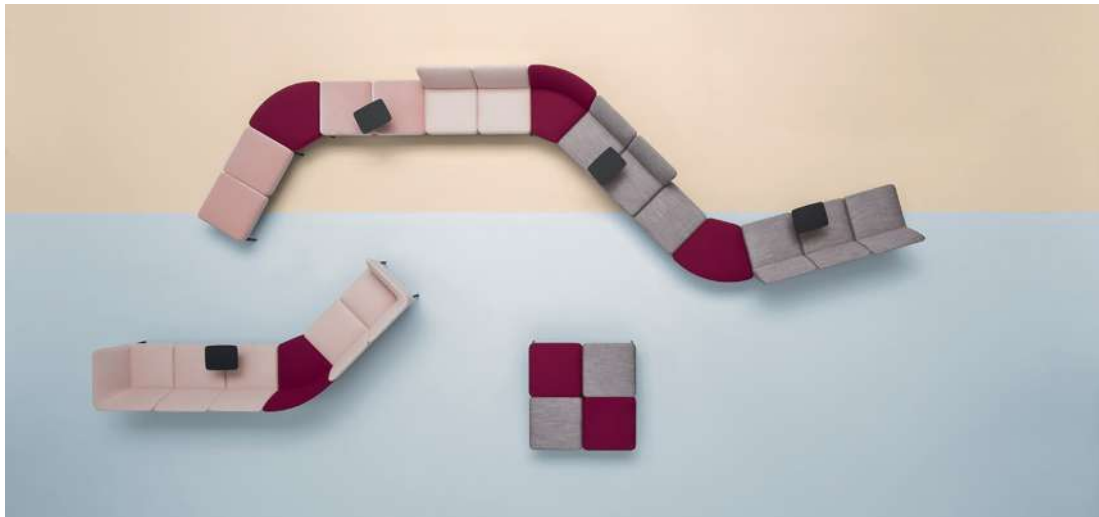
## Social corner 45° - 60° - 90° / tablet



CODE Codice	SEAT Sedile	BACK Schienale	FABRIC Tessuto	POWDER COATED Verniciato	POLISHED ALUMINIUM Alluminio lucidato	TOP Ripiano
<b>DSO45C</b> Corner 45° with backrest Angolo 45° con schienale	A	A	€ 681,00			
	C*	C*	€ 728,00			
	D40÷D44	D40÷D44	€ 784,00			
	D120÷D123	D120÷D123	€ 917,00			
	E	E	€ 868,00			
	G	G	€ 748,00			
	H	H	€ 909,00			
	N*	N*	€ 982,00			
P*	P*	€ 681,00				
TC**	TC**					
**TC = Minimum order 10 pcs each fabric colour (single seat unit) / Ordine minimo 10 pz per colore/tessuto (sedute singole)						
<b>DSO60P</b> Corner 60° without backrest Angolo 60° senza schienale	A		€ 511,00			
	C*		€ 561,00			
	D40÷D44		€ 620,00			
	D120÷D123		€ 747,00			
	E		€ 710,00			
	G		€ 582,00			
	H		€ 753,00			
	N*		€ 712,00			
P*		€ 511,00				
TC**						
**TC = Minimum order 10 pcs each fabric colour (single seat unit) / Ordine minimo 10 pz per colore/tessuto (sedute singole)						
<b>DSO90C</b> Corner 90° with backrest Angolo 90° con schienale	A	A		€ 1.431,00	€ 1.477,00	
	C*	C*		€ 1.525,00	€ 1.571,00	
	D40÷D44	D40÷D44		€ 1.636,00	€ 1.683,00	
	D120÷D123	D120÷D123		€ 1.833,00	€ 1.879,00	
	E	E		€ 1.805,00	€ 1.851,00	
	G	G		€ 1.564,00	€ 1.611,00	
	H	H		€ 1.886,00	€ 1.932,00	
	N*	N*		€ 2.033,00	€ 2.079,00	
P*	P*		€ 1.431,00	€ 1.477,00		
TC**	TC**					
**TC = Minimum order 10 pcs each fabric colour (single seat unit) / Ordine minimo 10 pz per colore/tessuto (sedute singole)						
<b>DSO/TT</b> Turning tablet Tavoletta girevole						<p>€ 151,00</p>  <p>CFP_BI FNP_NE*</p> <p>*Anti-fingerprint finish Finitura anti-impronta</p>

\* Excluding / Escluso C36+C39, N20+N27, PBS-PCO-PMS-PVE

The modules are not freestanding. They must be combined on both sides with linear modules.  
Moduli non autoportanti. Da abbinare su entrambi i lati a moduli lineari.

For fabrics see page 367  
Per i tessuti si veda a p. 367

For colours and finishes see at page 362  
Per colori e finiture vedere da pagina 362

### TECHNICAL DETAILS / Dettagli tecnici

#### DSO45C



1 pc KD  
MC 0,405

FABRIC REQUIRED /  
Fabbisogno tessuto  
1pc: Lin Mtrs 1,50 (h 1,40)

#### DSO90C

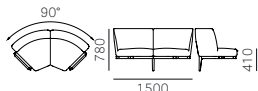

1 pc KD  
MC 0,77

FABRIC REQUIRED /  
Fabbisogno tessuto  
1pc: Lin Mtrs 3,00 (h 1,40)

#### DSO60P



1 pc KD  
MC 0,295

FABRIC REQUIRED /  
Fabbisogno tessuto  
1pc: Lin Mtrs 1,60 (h 1,40)

#### DSO/TT



1 pc KD  
MC 0,022

### SAFETY, STRENGTH and DURABILITY TESTS

Prove di sicurezza, resistenza e durata  
EN 1728:2012+AC2013  
EN 16139:2013 level 2

## Social Plus

Two seats  
Due sedute

CODE Codice	SEAT Sedile	BACK Schienale	POWDER COATED Verniciato	POLISHED ALUMINIUM Alluminio lucidato	FABRIC Tessuto
DSO2_2L	A	A	€ 1.467,00	€ 1.539,00	
	C*	C*	€ 1.599,00	€ 1.671,00	
	D40÷D44	D40÷D44	€ 1.754,00	€ 1.825,00	
	D120÷D123	D120÷D123	€ 2.079,00	€ 2.151,00	
	E	E	€ 1.991,00	€ 2.062,00	
	G	G	€ 1.654,00	€ 1.725,00	
	H	H	€ 2.103,00	€ 2.175,00	
	N*	N*	€ 2.162,00	€ 2.233,00	
	P*	P*	€ 1.467,00	€ 1.539,00	
	TC**	TC**			
**TC = Minimum order 10 pcs each fabric colour (single seat unit) / Ordine minimo 10 pz per colore/tessuto (sedute singole)					
DSO2_2AL	A	A	€ 1.616,00	€ 1.688,00	
	C*	C*	€ 1.745,00	€ 1.818,00	
	D40÷D44	D40÷D44	€ 1.896,00	€ 1.968,00	
	D120÷D123	D120÷D123	€ 2.235,00	€ 2.307,00	
	E	E	€ 2.128,00	€ 2.200,00	
	G	G	€ 1.798,00	€ 1.869,00	
	H	H	€ 2.237,00	€ 2.309,00	
	N*	N*	€ 2.407,00	€ 2.478,00	
	P*	P*	€ 1.616,00	€ 1.688,00	
	TC**	TC**			
**TC = Minimum order 10 pcs each fabric colour (single seat unit) / Ordine minimo 10 pz per colore/tessuto (sedute singole)					
DSO2_2A	A	A	€ 1.766,00	€ 1.837,00	
	C*	C*	€ 1.892,00	€ 1.963,00	
	D40÷D44	D40÷D44	€ 2.039,00	€ 2.111,00	
	D120÷D123	D120÷D123	€ 2.393,00	€ 2.464,00	
	E	E	€ 2.266,00	€ 2.337,00	
	G	G	€ 1.942,00	€ 2.015,00	
	H	H	€ 2.372,00	€ 2.443,00	
	N*	N*	€ 2.651,00	€ 2.723,00	
	P*	P*	€ 1.766,00	€ 1.837,00	
	TC**	TC**			
**TC = Minimum order 10 pcs each fabric colour (single seat unit) / Ordine minimo 10 pz per colore/tessuto (sedute singole)					
 DSO2.3 Cushion only Solo cuscino	A	A			€ 64,00
	C	C			€ 76,00
	D40÷D44	D40÷D44			€ 90,00
	D120÷D123	D120÷D123			€ 110,00
	E	E			€ 110,00
	G	G			€ 80,00
	H	H			€ 121,00
N*	N*			€ 156,00	
P*	P*			€ 64,00	
TC**	TC**				
**TC = Minimum order 10 pcs each fabric colour (single seat unit) / Ordine minimo 10 pz per colore/tessuto (sedute singole)					
DSO_LINK	Connecting plate kit for DSO2 sofas: surcharge € 24,00 Kit lamiera di collegamento per divani DSO2: supplemento € 24,00				

\* Excluding / Escluso C36+C39, N20+N27, PBS-PCO-PMS-PVE

For fabrics see page 367  
Per i tessuti si veda a p. 367For colours and finishes see at page 362  
Per colori e finiture vedere da pagina 362

## SAFETY, STRENGTH and DURABILITY TESTS

Prove di sicurezza, resistenza e durata  
EN 1728:2012+AC2013  
EN 16139:2013 level 2

## TECHNICAL DETAILS / Dettagli tecnici

## DSO2\_2L



1 pc MC 0,52

34,5 kg

FABRIC REQUIRED /  
Fabbisogno tessuto

1pc: Lin Mtrs 4,40 (h 1,40)

## DSO2\_2AL

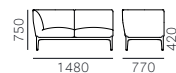

1 pc MC 0,88

37 kg

FABRIC REQUIRED /  
Fabbisogno tessuto

1pc: Lin Mtrs 4,30 (h 1,40)

## DSO2\_2A



1 pc MC 0,40

39,5 kg

FABRIC REQUIRED /  
Fabbisogno tessuto

1pc: Lin Mtrs 4,20 (h 1,40)

## DSO2.3



2 pcs MC 0,045

0,7 kg

FABRIC REQUIRED /  
Fabbisogno tessuto

1pc: Lin Mtrs 0,40 (h 1,40)

## Social Plus

Three seats  
Tre sedute

CODE Codice	SEAT Sedile	BACK Schienale	POWDER COATED Verniciato	POLISHED ALUMINIUM Alluminio lucidato	FABRIC Tessuto
DSO2_3L	A	A	€ 2.124,00	€ 2.201,00	
	C*	C*	€ 2.321,00	€ 2.400,00	
	D40÷D44	D40÷D44	€ 2.553,00	€ 2.631,00	
	D120÷D123	D120÷D123			
	E	E	€ 3.043,00	€ 3.121,00	
	G	G	€ 2.909,00	€ 2.986,00	
	H	H	€ 2.402,00	€ 2.481,00	
	N*	N*	€ 3.076,00	€ 3.154,00	
	P*	P*	€ 3.165,00	€ 3.243,00	
	TC**	TC**	€ 2.124,00	€ 2.201,00	
**TC = Minimum order 10 pcs each fabric colour (single seat unit) / Ordine minimo 10 pz per colore/tessuto (sedute singole)					
DSO2_3ALL	A	A	€ 2.273,00	€ 2.350,00	
	C*	C*	€ 2.468,00	€ 2.545,00	
	D40÷D44	D40÷D44	€ 2.696,00	€ 2.774,00	
	D120÷D123	D120÷D123			
	E	E	€ 3.199,00	€ 3.276,00	
	G	G	€ 3.047,00	€ 3.124,00	
	H	H	€ 2.547,00	€ 2.625,00	
	N*	N*	€ 3.211,00	€ 3.289,00	
	P*	P*	€ 3.410,00	€ 3.488,00	
	TC**	TC**	€ 2.273,00	€ 2.350,00	
**TC = Minimum order 10 pcs each fabric colour (single seat unit) / Ordine minimo 10 pz per colore/tessuto (sedute singole)					
DSO2_3AAL	A	A	€ 2.422,00	€ 2.499,00	
	C*	C*	€ 2.613,00	€ 2.691,00	
	D40÷D44	D40÷D44	€ 2.839,00	€ 2.916,00	
	D120÷D123	D120÷D123			
	E	E	€ 3.356,00	€ 3.433,00	
	G	G	€ 3.184,00	€ 3.261,00	
	H	H	€ 2.692,00	€ 2.769,00	
	N*	N*	€ 3.346,00	€ 3.423,00	
	P*	P*	€ 3.655,00	€ 3.733,00	
	TC**	TC**	€ 2.422,00	€ 2.499,00	
**TC = Minimum order 10 pcs each fabric colour (single seat unit) / Ordine minimo 10 pz per colore/tessuto (sedute singole)					
 <b>DSO2.3</b> Cushion only Solo cuscino	A	A			€ 64,00
	C	C			€ 76,00
	D40÷D44	D40÷D44			€ 90,00
	D120÷D123	D120÷D123			€ 110,00
	E	E			€ 110,00
	G	G			€ 80,00
	H	H			€ 121,00
N*	N*			€ 156,00	
P*	P*			€ 156,00	
TC**	TC**			€ 64,00	
**TC = Minimum order 10 pcs each fabric colour (single seat unit) / Ordine minimo 10 pz per colore/tessuto (sedute singole)					
<b>DSO_LINK</b>	Connecting plate kit for DSO2 sofas: surcharge € 24,00 Kit lamiera di collegamento per divani DSO2: supplemento € 24,00				

\* Excluding / Escluso C36+C39, N20+N27, PBS-PCO-PMS-PVE

For fabrics see page 367  
Per i tessuti si veda a p. 367For colours and finishes see at page 362  
Per colori e finiture vedere da pagina 362

## SAFETY, STRENGTH and DURABILITY TESTS

Prove di sicurezza, resistenza e durata  
EN 1728:2012+AC2013  
EN 16139:2013 level 2

## TECHNICAL DETAILS / Dettagli tecnici

## DSO2\_3L

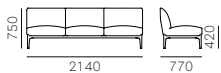

1 pc MC 0,53

49,5 kg

FABRIC REQUIRED /  
Fabbisogno tessuto

1pc: Lin Mtrs 6,60 (h 1,40)

## DSO2\_3AAL



1 pc MC 0,88

55 kg

FABRIC REQUIRED /  
Fabbisogno tessuto

1pc: Lin Mtrs 6,40 (h 1,40)

## DSO2\_3ALL

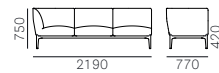

1 pc MC 0,88

52 kg

FABRIC REQUIRED /  
Fabbisogno tessuto

1pc: Lin Mtrs 6,50 (h 1,40)

## DSO2.3



2 pcs MC 0,045

0,7 kg

FABRIC REQUIRED /  
Fabbisogno tessuto

1pc: Lin Mtrs 0,40 (h 1,40)

## Social Plus

Four seats  
Quattro sedute

CODE Codice	SEAT Sedile	BACK Schienale	POWDER COATED Verniciato	POLISHED ALUMINIUM Alluminio lucidato	FABRIC Tessuto
DSO2_4L	A	A	€ 2.851,00	€ 2.936,00	
	C*	C*	€ 3.115,00	€ 3.200,00	
	D40÷D44 D120÷D123	D40÷D44 D120÷D123	€ 3.424,00	€ 3.509,00	
	E	E	€ 4.076,00	€ 4.161,00	
	G	G	€ 3.899,00	€ 3.983,00	
	H	H	€ 3.223,00	€ 3.307,00	
	N*	N*	€ 4.122,00	€ 4.206,00	
	P*	P*	€ 4.241,00	€ 4.325,00	
	TC**	TC**	€ 2.851,00	€ 2.936,00	
**TC = Minimum order 10 pcs each fabric colour (single seat unit) / Ordine minimo 10 pz per colore/tessuto (sedute singole)					
DSO2_4ALL	A	A	€ 3.000,00	€ 3.084,00	
	C*	C*	€ 3.261,00	€ 3.346,00	
	D40÷D44 D120÷D123	D40÷D44 D120÷D123	€ 3.567,00	€ 3.652,00	
	E	E	€ 4.233,00	€ 4.317,00	
	G	G	€ 4.036,00	€ 4.121,00	
	H	H	€ 3.367,00	€ 3.452,00	
	N*	N*	€ 4.257,00	€ 4.341,00	
	P*	P*	€ 4.486,00	€ 4.570,00	
	TC**	TC**	€ 3.000,00	€ 3.084,00	
**TC = Minimum order 10 pcs each fabric colour (single seat unit) / Ordine minimo 10 pz per colore/tessuto (sedute singole)					
DSO2_4AALL	A	A	€ 3.149,00	€ 3.233,00	
	C*	C*	€ 3.407,00	€ 3.491,00	
	D40÷D44 D120÷D123	D40÷D44 D120÷D123	€ 3.710,00	€ 3.794,00	
	E	E	€ 4.388,00	€ 4.474,00	
	G	G	€ 4.173,00	€ 4.257,00	
	H	H	€ 3.512,00	€ 3.597,00	
	N*	N*	€ 4.391,00	€ 4.475,00	
	P*	P*	€ 4.730,00	€ 4.815,00	
	TC**	TC**	€ 3.149,00	€ 3.233,00	
**TC = Minimum order 10 pcs each fabric colour (single seat unit) / Ordine minimo 10 pz per colore/tessuto (sedute singole)					
 DSO2.3 Cushion only Solo cuscino	A	A			€ 64,00
	C	C			€ 76,00
	D40÷D44 D120÷D123	D40÷D44 D120÷D123			€ 90,00
	E	E			€ 110,00
	G	G			€ 110,00
	H	H			€ 80,00
	N*	N*			€ 121,00
	P*	P*			€ 156,00
	TC**	TC**			€ 64,00
**TC = Minimum order 10 pcs each fabric colour (single seat unit) / Ordine minimo 10 pz per colore/tessuto (sedute singole)					
DSO_LINK	Connecting plate kit for DSO2 sofas: surcharge € 24,00 Kit lamiera di collegamento per divani DSO2: supplemento € 24,00				







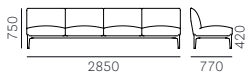

\* Excluding / Escluso C36-C39, N20-N27, PBS-PCO-PMS-PVE

For fabrics see page 367  
Per i tessuti si veda a p. 367For colours and finishes see at page 362  
Per colori e finiture vedere da pagina 362

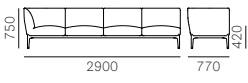
## SAFETY, STRENGTH and DURABILITY TESTS

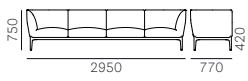
Prove di sicurezza, resistenza e durata  
EN 1728:2012+AC2013  
EN 16139:2013 level 2

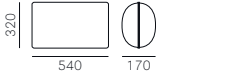
## TECHNICAL DETAILS / Dettagli tecnici

<b>DSO2_4L</b>   1 pc 81,5 kg <b>FABRIC REQUIRED /</b> Fabbisogno tessuto 1pc: Lin Mtrs 8,80 (h 1,40)	<b>DSO2_4ALL</b>   1 pc 84 kg <b>FABRIC REQUIRED /</b> Fabbisogno tessuto 1pc: Lin Mtrs 8,70 (h 1,40)
<b>DSO2_4AALL</b>   1 pc 87 kg <b>FABRIC REQUIRED /</b> Fabbisogno tessuto 1pc: Lin Mtrs 8,60 (h 1,40)	<b>DSO2.3</b>   2 pcs 0,7 kg <b>FABRIC REQUIRED /</b> Fabbisogno tessuto 1pc: Lin Mtrs 0,40 (h 1,40)

# Soul 3745



SEAT Sedile	BACK Schienale	FRAME Telaio	BLEACHED ASH Frassino sbiancato	BLACK LACQUERED ASH Frassino laccato nero	ASH STAINED WALNUT Frassino tinto noce
	FR	FR	<b>€ 484,00</b> (TR, BI)		
PC	N2	N2			<b>€ 484,00</b> (TR, BI, FU)
	AN	AN		<b>€ 484,00</b> (NE, FU)	

PC FINISHES / Finiture PC

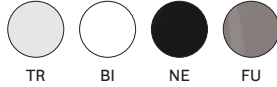

WOODEN FINISHES / Finiture legno



PACKING / Imballo



TECHNICAL DETAILS / Dettagli tecnici



**SAFETY, STRENGTH and DURABILITY TESTS**  
 Prove di sicurezza, resistenza e durata  
 EN 1728:2012+AC2013  
 EN 16139:2013 level 2



# Soul 3746

OUTDOOR



SEAT Sedile	BACK Schienale	FRAME Telaio	POWDER COATED Verniciato	ANODIZED ALUMINIUM Alluminio anodizzato
TEAK	METAL Ø 30	METAL Ø 30	<b>€ 340,00</b>	<b>€ 409,00</b>

FINISHES / Finiture



PACKING / Imballo



TECHNICAL DETAILS / Dettagli tecnici

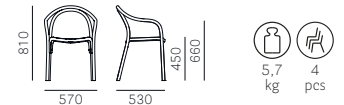

**SAFETY, STRENGTH and DURABILITY TESTS**  
 Prove di sicurezza, resistenza e durata  
 ANSI-BIFMA X5.1-2017

# Soul 3747

SOFT



SEAT Sedile	BACK Schienale	FRAME Telaio	ASH Frassino
C110+C122 C210+C217			<b>€ 623,00</b>
H20+H35; H100+H108 H120+H127	FR-N2 AN	FR-N2 AN	<b>€ 633,00</b>
G*			<b>€ 691,00</b>
P*			<b>€ 726,00</b>

\* Excluding / Escluso G100+G102, G180+G185, G230+G239,  
 PBS-PCO-PMS-PVE

FINISHES / Finiture



For fabrics see page 367  
 Per i tessuti si veda a p. 367

PACKING / Imballo



TECHNICAL DETAILS / Dettagli tecnici

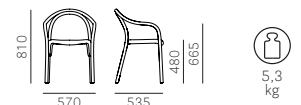

**SAFETY, STRENGTH and DURABILITY TESTS**  
 Prove di sicurezza, resistenza e durata  
 EN 1728:2012+AC2013  
 EN 16139:2013 level 2



## Souvenir 550RM



recycled polypropylene.



SEAT Sedile	BACK Schienale	FRAME Telaio
PPL	PPL	PPL

POLYPROPYLENE  
Polipropilene

€ 75,00

PPL FINISHES / Finiture PPL



GR

PACKING / Imballo



MC 0,405

TECHNICAL DETAILS / Dettagli tecnici

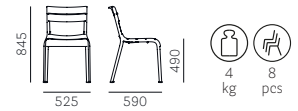

SAFETY, STRENGTH and DURABILITY TESTS  
Prove di sicurezza, resistenza e durata  
EN 1728:2012+AC2013  
EN 16139:2013 level 2



PRODUCT CERTIFIED  
FOR LOW CHEMICAL  
EMISSIONS:  
UL.COM/GG  
UL 2818

## Souvenir 550



SEAT Sedile	BACK Schienale	FRAME Telaio
PPL	PPL	PPL

POLYPROPYLENE  
Polipropilene

€ 75,00

PPL FINISHES / Finiture PPL



BI

NE

GC

RA

RO

VE

PACKING / Imballo



MC 0,405

TECHNICAL DETAILS / Dettagli tecnici



SAFETY, STRENGTH and DURABILITY TESTS  
Prove di sicurezza, resistenza e durata  
EN 1728:2012+AC2013  
EN 16139:2013 level 2



PRODUCT CERTIFIED  
FOR LOW CHEMICAL  
EMISSIONS:  
UL.COM/GG  
UL 2818

## Souvenir 555RM



recycled polypropylene.



SEAT Sedile	BACK Schienale	FRAME Telaio
PPL	PPL	PPL

POLYPROPYLENE  
Polipropilene

€ 91,00

PPL FINISHES / Finiture PPL



GR

PACKING / Imballo



MC 0,485

TECHNICAL DETAILS / Dettagli tecnici

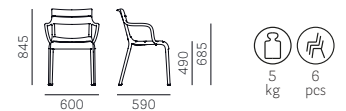

SAFETY, STRENGTH and DURABILITY TESTS  
Prove di sicurezza, resistenza e durata  
EN 1728:2012+AC2013  
EN 16139:2013 level 2



PRODUCT CERTIFIED  
FOR LOW CHEMICAL  
EMISSIONS:  
UL.COM/GG  
UL 2818

## Souvenir 555



SEAT Sedile	BACK Schienale	FRAME Telaio	POLYPROPYLENE Polipropilene
PPL	PPL	PPL	€ 91,00

PPL FINISHES / Finiture PPL



PACKING / Imballo



TECHNICAL DETAILS / Dettagli tecnici

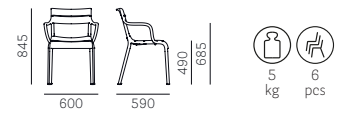

## Sunset 625



SEAT Sedile	BACK Schienale	FRAME Telaio	POLYETHYLENE Polietilene
PET	PET	PET	€ 412,00

PET FINISHES / Finiture PET



PACKING / Imballo



TECHNICAL DETAILS / Dettagli tecnici

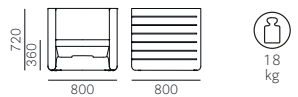

## Sunset 625.10

Seat + back cushion  
Cuscino per sedile e schienale



SEAT Sedile	BACK Schienale	FABRIC Tessuto
D22+D26 D80+D89 D100+D105 D110+D115 D130+D133	D22+D26 D80+D89 D100+D105 D110+D115 D130+D133	€ 324,00

We suggest to remove the cushions over night and in rainy days  
Si consiglia di ritirare i cuscini durante la notte e in caso di pioggia

For fabrics see page 367  
Per i tessuti si veda a p. 367

PACKING / Imballo



TECHNICAL DETAILS / Dettagli tecnici

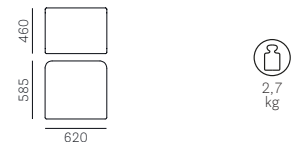



## Sunset 625.3

Seat cushion  
Cuscino per sedile



SEAT Sedile	FABRIC Tessuto
D22+D26 D80+D89 D100+D105 D110+D115 D130+D133	€ 174,00

We suggest to remove the cushions over night and in rainy days  
Si consiglia di ritirare i cuscini durante la notte e in caso di pioggia  
For fabrics see page 367  
Per i tessuti si veda a p. 367

PACKING / Imballo



TECHNICAL DETAILS / Dettagli tecnici

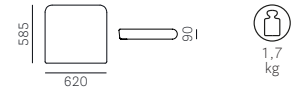

## Sunset 626

SOFA



SEAT Sedile	BACK Schienale	FRAME Telaio	POLYETHYLENE Polietilene
PET	PET	PET	€ 728,00

PET FINISHES / Finiture PET



PACKING / Imballo



TECHNICAL DETAILS / Dettagli tecnici

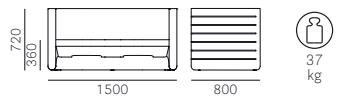

## Sunset 626.10

Seat + back cushion  
Cuscino per sedile e schienale



SEAT Sedile	BACK Schienale	FABRIC Tessuto
D22+D26 D80+D89 D100+D105 D110+D115 D130+D133	D22+D26 D80+D89 D100+D105 D110+D115 D130+D133	€ 532,00

We suggest to remove the cushions over night and in rainy days  
Si consiglia di ritirare i cuscini durante la notte e in caso di pioggia  
For fabrics see page 367  
Per i tessuti si veda a p. 367

PACKING / Imballo



TECHNICAL DETAILS / Dettagli tecnici

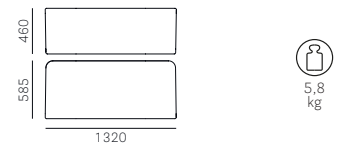

## Sunset 626.3

Seat cushion  
Cuscino per sedile



SEAT Sedile	FABRIC Tessuto
D22+D26 D80+D89 D100+D105 D110+D115 D130+D133	<b>€ 289,00</b>

We suggest to remove the cushions over night and in rainy days  
Si consiglia di ritirare i cuscini durante la notte e in caso di pioggia  
For fabrics see page 367  
Per i tessuti si veda a p. 367

PACKING / Imballo



TECHNICAL DETAILS / Dettagli tecnici

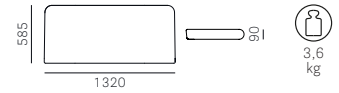

## Sunset 625.20

Supporting HPL top  
Piano d'appoggio



TOP Ripiano	FRAME Telaio	SOLID LAMINATE Stratificato
CFP_BI	BI100E	<b>€ 84,00</b> For Sunset BI, SA
COP_234	BE200E	<b>€ 84,00</b> For Sunset BE

FINISHES / Finiture

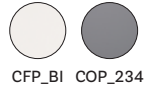

PACKING / Imballo



TECHNICAL DETAILS / Dettagli tecnici

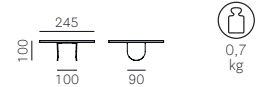

## Sunset 625.30

Double supporting HPL top  
Doppio piano d'appoggio



TOP Ripiano	FRAME Telaio	SOLID LAMINATE Stratificato
CFP_BI	BI100E	<b>€ 86,00</b> For Sunset BI, SA
COP_234	BE200E	<b>€ 86,00</b> For Sunset BE

FINISHES / Finiture



PACKING / Imballo



TECHNICAL DETAILS / Dettagli tecnici

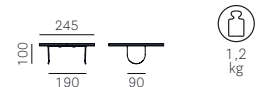

## Tatami 305



SEAT Sedile	BACK Schienale	FRAME Telaio	POLYPROPYLENE Polipropilene
PPL	PPL	PPL	€ 57,00

PPL FINISHES / Finiture PPL



PACKING / Imballo



TECHNICAL DETAILS / Dettagli tecnici

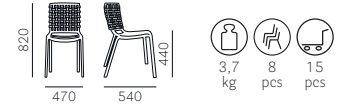

SAFETY, STRENGTH and DURABILITY TESTS  
Prove di sicurezza, resistenza e durata  
EN 1728:2000



## Tatami 306



SEAT Sedile	BACK Schienale	FRAME Telaio	POLYPROPYLENE Polipropilene
PPL	PPL	PPL	€ 74,00

PPL FINISHES / Finiture PPL



PACKING / Imballo



TECHNICAL DETAILS / Dettagli tecnici



SAFETY, STRENGTH and DURABILITY TESTS  
Prove di sicurezza, resistenza e durata  
EN 1728:2000



## Temps 3765



SEAT Sedile	BACK Schienale	FRAME Telaio	WHITE/BLACK POWDER COATED Verniciato bianco/nero	POLISHED ALUMINIUM Alluminio lucidato
C83+C89; C100+C101 C110+C122 C210+C217	C83+C89; C100+C101 C110+C122 C210+C217	Ø 750	€ 599,00	€ 660,00*
G59+G78; G190+G197 G140+G146 G160+G169 G170+G176; G210+G213	G59+G78; G190+G197 G140+G146 G160+G169 G170+G176; G210+G213		€ 700,00	€ 761,00*
H60 H120+H127	H60 H120+H127		€ 613,00	€ 674,00*

\*Armrest finish: black only  
Finitura bracciolo: solo nero

PPL FINISHES / Finiture PPL

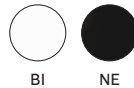

PACKING / Imballo



TECHNICAL DETAILS / Dettagli tecnici



SAFETY, STRENGTH and DURABILITY TESTS  
Prove di sicurezza, resistenza e durata  
EN 1728:2012+AC2013  
EN 1335-2:2018  
ANSI-BIFMA X5.1-2017

For fabrics see page 367  
Per i tessuti si veda a p. 367

# Temps 3766

LOW BACK



SEAT Sedile	BACK Schienale	FRAME Telaio	WHITE/BLACK POWDER COATED Verniciato bianco/nero	POLISHED ALUMINIUM Alluminio lucidato
C83+C89; C100+C101 C110+C122 C210+C217	C83+C89; C100+C101 C110+C122 C210+C217	Ø 750	<b>€ 575,00</b>	<b>€ 636,00*</b>
G59+G78; G190+G197 G140+G146 G160+G169 G170+G176; G210+G213	G59+G78; G190+G197 G140+G146 G160+G169 G170+G176; G210+G213		<b>€ 676,00</b>	<b>€ 736,00*</b>
H60 H120+H127	H60 H120+H127		<b>€ 589,00</b>	<b>€ 649,00*</b>

\*Armrest finish: black only  
Finitura bracciolo: solo nero

PPL FINISHES / Finiture PPL

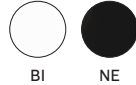

For fabrics see page 367  
Per i tessuti si veda a p. 367

PACKING / Imballo



TECHNICAL DETAILS / Dettagli tecnici



**SAFETY, STRENGTH and DURABILITY TESTS**  
Prove di sicurezza, resistenza e durata  
EN 1728:2012+AC2013  
EN 1335-2:2018  
ANSI-BIFMA X5.1-2017

# Tivoli 2800



SEAT Sedile	BACK Schienale	FRAME Telaio	ASH Frassino	ASH STAINED ON SAMPLE Frassino tinto campione
FR-N1-GC- BI-AN	FR-N1-GC- BI-AN	FR-N1-GC- BI-AN	<b>€ 414,00</b>	
TC	TC	TC		<b>€ 437,00</b>

FINISHES / Finiture

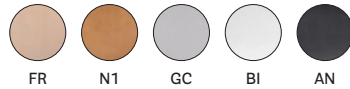

**SAFETY, STRENGTH and DURABILITY TESTS**  
Prove di sicurezza, resistenza e durata  
EN 1728:2012+AC2013  
EN 16139:2013 level 2

PACKING / Imballo



TECHNICAL DETAILS / Dettagli tecnici



# Tivoli 2800



SEAT Sedile	BACK Schienale	FRAME Telaio	ASH Frassino
BL2 AZ1 VE2 VE1 RB RA MO MC	BL2 AZ1 VE2 VE1 RB RA MO MC	BL2 AZ1 VE2 VE1 RB RA MO MC	<b>€ 426,00</b> Lacquered with visible grains Laccato a poro aperto

FINISHES / Finiture



**SAFETY, STRENGTH and DURABILITY TESTS**  
Prove di sicurezza, resistenza e durata  
EN 1728:2012+AC2013  
EN 16139:2013 level 2

PACKING / Imballo



TECHNICAL DETAILS / Dettagli tecnici



## Tivoli 2801



SEAT Sedile	BACK Schienale	FRAME Telaio	ASH Frassino	ASH STAINED ON SAMPLE Frassino tinto campione
A	A		<b>€ 479,00</b>	<b>€ 502,00</b>
C*	C*	FR-N1-GC- BI-AN	<b>€ 496,00</b>	<b>€ 519,00</b>
G	G		<b>€ 549,00</b>	<b>€ 572,00</b>
H*	H*	TC	<b>€ 500,00</b>	<b>€ 523,00</b>
P*	P*		<b>€ 568,00</b>	<b>€ 591,00</b>

\*Excluding / Escluso C36+C39, H140+H143, PBS-PCO-PMS-PVE

For fabrics see page 367  
Per i tessuti si veda a p. 367

### FINISHES / Finiture



### PACKING / Imballo



### TECHNICAL DETAILS / Dettagli tecnici



**SAFETY, STRENGTH and DURABILITY TESTS**  
Prove di sicurezza, resistenza e durata  
EN 1728:2012+AC2013  
EN 16139:2013 level 2

## Tivoli 2802



SEAT Sedile	BACK Schienale	FRAME Telaio	ASH Frassino	ASH STAINED ON SAMPLE Frassino tinto campione
A			<b>€ 447,00</b>	<b>€ 470,00</b>
C*	FR-N1-GC- BI-AN	FR-N1-GC- BI-AN	<b>€ 455,00</b>	<b>€ 478,00</b>
G			<b>€ 482,00</b>	<b>€ 505,00</b>
H*	TC	TC	<b>€ 457,00</b>	<b>€ 480,00</b>
P*			<b>€ 491,00</b>	<b>€ 514,00</b>

\*Excluding / Escluso C36+C39, H140+H143, PBS-PCO-PMS-PVE

### FINISHES / Finiture



### PACKING / Imballo



### TECHNICAL DETAILS / Dettagli tecnici



**SAFETY, STRENGTH and DURABILITY TESTS**  
Prove di sicurezza, resistenza e durata  
EN 1728:2012+AC2013  
EN 16139:2013 level 2

## Tivoli 2805



SEAT Sedile	BACK Schienale	FRAME Telaio	ASH Frassino	ASH STAINED ON SAMPLE Frassino tinto campione
FR-N1-GC- BI-AN	FR-N1-GC- BI-AN	FR-N1-GC- BI-AN	<b>€ 477,00</b>	
TC	TC	TC		<b>€ 500,00</b>

### FINISHES / Finiture



### PACKING / Imballo



### TECHNICAL DETAILS / Dettagli tecnici



**SAFETY, STRENGTH and DURABILITY TESTS**  
Prove di sicurezza, resistenza e durata  
EN 1728:2012+AC2013  
EN 16139:2013 level 2



PRODUCT CERTIFIED  
FOR LOW CHEMICAL  
EMISSIONS:  
UL.COM/GG  
UL 2818

## Tivoli 2805



SEAT Sedile	BACK Schienale	FRAME Telaio
BL2	BL2	BL2
AZ1	AZ1	AZ1
VE2	VE2	VE2
VE1	VE1	VE1
RB	RB	RB
RA	RA	RA
MO	MO	MO
MC	MC	MC

ASH  
Frassino

**€ 488,00**  
Lacquered with visible grains  
Laccato a poro aperto

FINISHES / Finiture



SAFETY, STRENGTH and DURABILITY TESTS  
Prove di sicurezza, resistenza e durata  
EN 1728:2012+AC2013  
EN 16139:2013 level 2

PACKING / Imballo



TECHNICAL DETAILS / Dettagli tecnici



## Tivoli 2806



SEAT Sedile	BACK Schienale	FRAME Telaio
A	A	
C*	C*	FR-N1-GC- BI-AN
G	G	TC
H*	H*	
P*	P*	

ASH  
Frassino

**€ 554,00**

**€ 573,00**

**€ 632,00**

**€ 577,00**

**€ 652,00**

ASH STAINED ON SAMPLE  
Frassino tinto campione

**€ 577,00**

**€ 596,00**

**€ 655,00**

**€ 600,00**

**€ 675,00**

Minimum order q.ty: 20 pcs  
Ordine minimo: 20pz

\*Excluding / Escluso C36+C39, H140+H143, PBS-PCO-PMS-PVE

FINISHES / Finiture

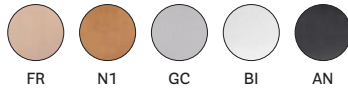

SAFETY, STRENGTH and DURABILITY TESTS  
Prove di sicurezza, resistenza e durata  
EN 1728:2012+AC2013  
EN 16139:2013 level 2

For fabrics see page 367  
Per i tessuti si veda a p. 367

PACKING / Imballo



TECHNICAL DETAILS / Dettagli tecnici



## Tivoli 2807



SEAT Sedile	BACK Schienale	FRAME Telaio
A		
C*	FR-N1-GC- BI-AN	FR-N1-GC- BI-AN
G		
H*	TC	TC
P*		

ASH  
Frassino

**€ 516,00**

**€ 525,00**

**€ 554,00**

**€ 528,00**

**€ 565,00**

ASH STAINED ON SAMPLE  
Frassino tinto campione

**€ 539,00**

**€ 548,00**

**€ 577,00**

**€ 551,00**

**€ 588,00**

Minimum order q.ty: 20 pcs  
Ordine minimo: 20pz

\*Excluding / Escluso C36+C39, H140+H143, PBS-PCO-PMS-PVE

FINISHES / Finiture



SAFETY, STRENGTH and DURABILITY TESTS  
Prove di sicurezza, resistenza e durata  
EN 1728:2012+AC2013  
EN 16139:2013 level 2

For fabrics see page 367  
Per i tessuti si veda a p. 367









PACKING / Imballo



TECHNICAL DETAILS / Dettagli tecnici

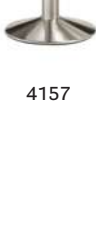

Tonda 4156-4157

CODE Codice	SEAT Sedile	FRAME Telaio	BLACK POWDER COATED Verniciato nero	POWDER COATED Verniciato	CHROMED Cromato	BRUSHED S/STEEL Inox satinato
 4156	Frame only / Solo telaio	 S_TX	€ 164,00	€ 172,00	€ 214,00	€ 267,00
	A		€ 207,00	€ 215,00	€ 257,00	€ 310,00
	C *		€ 219,00	€ 227,00	€ 269,00	€ 322,00
	G		€ 253,00	€ 261,00	€ 303,00	€ 356,00
	H *		€ 221,00	€ 229,00	€ 271,00	€ 324,00
	P *		€ 265,00	€ 273,00	€ 315,00	€ 368,00
	TC **		€ 207,00	€ 215,00	€ 257,00	€ 310,00
	CL **		€ 213,00	€ 221,00	€ 263,00	€ 316,00
	PG		€ 186,00	€ 194,00	€ 236,00	€ 289,00
**TC/CL= Minimum order 10 pcs each fabric colour TC/CL= Ordine minimo 10 pz per colore/tessuto						
 4156	Frame only / Solo telaio	 S350CON	€ 225,00	€ 233,00	€ 275,00	€ 328,00
	A		€ 241,00	€ 249,00	€ 291,00	€ 344,00
	C *		€ 289,00	€ 297,00	€ 339,00	€ 392,00
	G		€ 289,00	€ 297,00	€ 339,00	€ 392,00
	H *		€ 245,00	€ 253,00	€ 295,00	€ 348,00
	P *		€ 305,00	€ 313,00	€ 355,00	€ 408,00
	TC **		€ 225,00	€ 233,00	€ 275,00	€ 328,00
	CL **		€ 230,00	€ 238,00	€ 280,00	€ 333,00
	PG		€ 188,00	€ 196,00	€ 238,00	€ 291,00
**TC/CL= Minimum order 10 pcs each fabric colour TC/CL= Ordine minimo 10 pz per colore/tessuto						
 4157	Frame only / Solo telaio	 S_TX	€ 208,00	€ 216,00	€ 259,00	€ 311,00
	A		€ 251,00	€ 259,00	€ 302,00	€ 354,00
	C *		€ 263,00	€ 271,00	€ 314,00	€ 366,00
	G		€ 297,00	€ 305,00	€ 348,00	€ 400,00
	H *		€ 265,00	€ 273,00	€ 316,00	€ 368,00
	P *		€ 309,00	€ 317,00	€ 360,00	€ 412,00
	TC **		€ 251,00	€ 259,00	€ 302,00	€ 354,00
	CL **		€ 257,00	€ 265,00	€ 308,00	€ 360,00
	PG		€ 230,00	€ 238,00	€ 281,00	€ 333,00
**TC/CL= Minimum order 10 pcs each fabric colour TC/CL= Ordine minimo 10 pz per colore/tessuto						
 4157	Frame only / Solo telaio	 S350CON	€ 269,00	€ 277,00	€ 320,00	€ 372,00
	A		€ 285,00	€ 293,00	€ 336,00	€ 388,00
	C *		€ 333,00	€ 341,00	€ 384,00	€ 436,00
	G		€ 333,00	€ 341,00	€ 384,00	€ 436,00
	H *		€ 289,00	€ 297,00	€ 340,00	€ 392,00
	P *		€ 349,00	€ 357,00	€ 400,00	€ 452,00
	TC **		€ 269,00	€ 277,00	€ 320,00	€ 372,00
	CL **		€ 274,00	€ 282,00	€ 325,00	€ 377,00
	PG		€ 232,00	€ 240,00	€ 283,00	€ 335,00
**TC/CL= Minimum order 10 pcs each fabric colour TC/CL= Ordine minimo 10 pz per colore/tessuto						

\*Excluding / Escluso C36+C39, H140+H143, PBS-PCO-PMS-PVE

For fabrics see page 367  
Per i tessuti si veda a p. 367

TECHNICAL DETAILS / Dettagli tecnici

4156 S\_TX

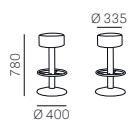

FABRIC REQUIRED / Fabbisogno tessuto  
1pc: Lin Mtrs 0,35 (h 1,40)

4156 S350CON

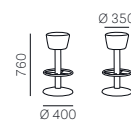

FABRIC REQUIRED / Fabbisogno tessuto  
1pc: Lin Mtrs 0,60 (h 1,40)

4157 S\_TX

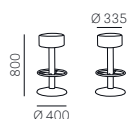

FABRIC REQUIRED / Fabbisogno tessuto  
1pc: Lin Mtrs 0,35 (h 1,40)

4157 S350CON

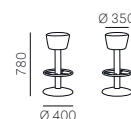

FABRIC REQUIRED / Fabbisogno tessuto  
1pc: Lin Mtrs 0,60 (h 1,40)

For colours and finishes see at page 362  
Per colori e finiture vedere da pagina 362

## Trend 447



SEAT Sedile	BACK Schienale	FRAME Telaio	CHROMED Cromato	MATT CHROMED Cromato opaco
F11 F12 F17 F18 F19	F11 F12 F17 F18 F19	Ø 16	€ 152,00	€ 165,00

\*Panel for stacking: surcharge € 22,00 (item IMP03)  
 Pannello per impilaggio: supplemento € 22,00 (art.IMP03)

REGENERATED LEATHER FINISHES / Finiture cuoio rigenerato



PACKING / Imballo



TECHNICAL DETAILS / Dettagli tecnici





## Trend 448



SEAT Sedile	BACK Schienale	FRAME Telaio	CHROMED Cromato
F11 F12 F17 F18 F19	F11 F12 F17 F18 F19	Ø 10	<b>€ 152,00</b>

\*Panel for stacking: surcharge € 22,00 (item IMP03)  
 Pannello per impilaggio:supplemento € 22,00 (art.IMP03)

REGENERATED LEATHER FINISHES / Finiture cuoio rigenerato



PACKING / Imballo



TECHNICAL DETAILS / Dettagli tecnici



## Tribeca 3660



SEAT Sedile	BACK Schienale	FRAME Telaio	POWDER COATED Verniciato
PVC	PVC	METAL Ø 20	<b>€ 216,00</b>

\*Flexible PVC profile in the same colour of the frame. Only for BI200 colour frame, PVC profile is in beige colour  
Intreccio in PVC flessibile in tinta con il telaio. Solo per il colore del telaio BI200, l'intreccio in PVC è color beige

### FINISHES / Finiture



### PACKING / Imballo



### TECHNICAL DETAILS / Dettagli tecnici

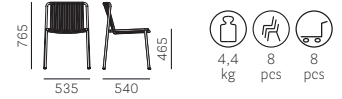

**SAFETY, STRENGTH and DURABILITY TESTS**  
Prove di sicurezza, resistenza e durata  
EN 1728:2012+AC2013  
EN 16139:2013 level 2

## Tribeca 3665



SEAT Sedile	BACK Schienale	FRAME Telaio	POWDER COATED Verniciato
PVC	PVC	METAL Ø 20	<b>€ 237,00</b>

\*Flexible PVC profile in the same colour of the frame. Only for BI200 colour frame, PVC profile is in beige colour  
Intreccio in PVC flessibile in tinta con il telaio. Solo per il colore del telaio BI200, l'intreccio in PVC è color beige

### FINISHES / Finiture



### PACKING / Imballo



### TECHNICAL DETAILS / Dettagli tecnici



**SAFETY, STRENGTH and DURABILITY TESTS**  
Prove di sicurezza, resistenza e durata  
EN 1728:2012+AC2013  
EN 16139:2013 level 2

## Tribeca 3667



SEAT Sedile	BACK Schienale	FRAME Telaio	POWDER COATED Verniciato
PVC	PVC	METAL Ø 20 H675	<b>€ 229,00</b>

\*Flexible PVC profile in the same colour of the frame. Only for BI200 colour frame, PVC profile is in beige colour  
Intreccio in PVC flessibile in tinta con il telaio. Solo per il colore del telaio BI200, l'intreccio in PVC è color beige

### FINISHES / Finiture



### PACKING / Imballo



### TECHNICAL DETAILS / Dettagli tecnici



**SAFETY, STRENGTH and DURABILITY TESTS**  
Prove di sicurezza, resistenza e durata  
EN 1728:2012+AC2013  
EN 16139:2013 level 2

## Tribeca 3668



SEAT Sedile	BACK Schienale	FRAME Telaio	POWDER COATED Verniciato
PVC	PVC	METAL Ø 20 H775	<b>€ 236,00</b>

\*Flexible PVC profile in the same colour of the frame. Only for BI200 colour frame, PVC profile is in beige colour  
Intreccio in PVC flessibile in tinta con il telaio. Solo per il colore del telaio BI200, l'intreccio in PVC è color beige

### FINISHES / Finiture



### PACKING / Imballo



### TECHNICAL DETAILS / Dettagli tecnici

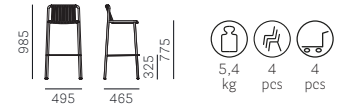

**SAFETY, STRENGTH and DURABILITY TESTS**  
Prove di sicurezza, resistenza e durata  
EN 1728:2012+AC2013  
EN 16139:2013 level 2

## Tribeca 3669

LOUNGE



SEAT Sedile	BACK Schienale	FRAME Telaio	POWDER COATED Verniciato
PVC	PVC	METAL Ø 20	<b>€ 286,00</b>

\*Flexible PVC profile in the same colour of the frame. Only for BI200 colour frame, PVC profile is in beige colour  
Intreccio in PVC flessibile in tinta con il telaio. Solo per il colore del telaio BI200, l'intreccio in PVC è color beige

### FINISHES / Finiture



### PACKING / Imballo



### TECHNICAL DETAILS / Dettagli tecnici

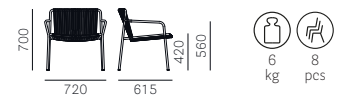

## Tribeca 3666

SOFA LOUNGE

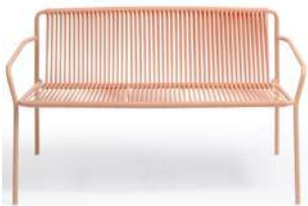

SEAT Sedile	BACK Schienale	FRAME Telaio	POWDER COATED Verniciato
PVC	PVC	METAL Ø 20	<b>€ 583,00</b>

\*Flexible PVC profile in the same colour of the frame. Only for BI200 colour frame, PVC profile is in beige colour  
Intreccio in PVC flessibile in tinta con il telaio. Solo per il colore del telaio BI200, l'intreccio in PVC è color beige

### FINISHES / Finiture



### PACKING / Imballo



### TECHNICAL DETAILS / Dettagli tecnici



## Trilly 1966



SEAT Sedile	CHROMED Cromato	SATINIZED Satinato
Frame only / Solo telaio	€ 95,00	€ 126,00
A	€ 156,00	€ 187,00
C*	€ 172,00	€ 203,00
G	€ 219,00	€ 251,00
H*	€ 175,00	€ 207,00
P*	€ 236,00	€ 267,00
TC**	€ 156,00	€ 187,00
CL**	€ 161,00	€ 192,00
PG	€ 119,00	€ 150,00

\*\*TC/CL = Minimum order 10 pcs each fabric colour  
TC/CL = Ordine minimo 10 pz per colore/tessuto

\*Excluding / Escluso C36+C39, H140+H143, PBS-PCO-PMS-PVE

For fabrics see page 367  
Per i tessuti si veda a p. 367

PACKING / Imballo



FABRIC REQUIRED / Fabbisogno tessuto  
1pc: Lin Mtrs 0,60 (h 1,40)

TECHNICAL DETAILS / Dettagli tecnici



## Trilly 1967



SEAT Sedile	CHROMED Cromato	SATINIZED Satinato
Frame only / Solo telaio	€ 126,00	€ 157,00
A	€ 186,00	€ 218,00
C*	€ 203,00	€ 234,00
G	€ 250,00	€ 282,00
H*	€ 206,00	€ 238,00
P*	€ 267,00	€ 298,00
TC**	€ 186,00	€ 218,00
CL**	€ 192,00	€ 223,00
PG	€ 150,00	€ 181,00

\*\*TC/CL = Minimum order 10 pcs each fabric colour  
TC/CL = Ordine minimo 10 pz per colore/tessuto

\*Excluding / Escluso C36+C39, H140+H143, PBS-PCO-PMS-PVE

For fabrics see page 367  
Per i tessuti si veda a p. 367

PACKING / Imballo



FABRIC REQUIRED / Fabbisogno tessuto  
1pc: Lin Mtrs 0,60 (h 1,40)

TECHNICAL DETAILS / Dettagli tecnici



## Tweet 890

One-colour  
Monocolore



SEAT Sedile	BACK Schienale	FRAME Telaio	POWDER COATED Verniciato	CHROMED Cromato	MATT CHROMED Cromato opaco
PPL	PPL	Ø 14	€ 95,00 AR, VE2, RA2 frame finish excluded Escluso telaio finitura AR, VE2, RA2	€ 95,00	€ 115,00

Fire-retardant version available on request: surcharge € 25,00 (item 890/CL1) - Minimum order 300 pcs each colour  
Disponibile a richiesta la versione ignifuga: supplemento € 25,00 (art. 890/CL1) - Ordine minimo 300 pz per colore

PPL FINISHES / Finiture PPL



PACKING / Imballo



TECHNICAL DETAILS / Dettagli tecnici



SAFETY, STRENGTH and DURABILITY TESTS  
Prove di sicurezza, resistenza e durata  
EN 1728:2012+AC2013  
EN 16139:2013 level 2

For colours and finishes see at page 362  
Per colori e finiture vedere da pagina 362



## Tweet 890

Bicolour  
Bicolore



SEAT Sedile	BACK Schienale	FRAME Telaio	POWDER COATED Verniciato	CHROMED Cromato	MATT CHROMED Cromato opaco
PPL	PPL	Ø 14	<b>€ 95,00</b> GI frame finish excluded Escluso telaio finitura GI	<b>€ 95,00</b>	<b>€ 115,00</b>

Fire-retardant version available on request: surcharge **€ 25,00** (item 890/CL1) - Minimum order 300 pcs each colour  
Disponibile a richiesta la versione ignifuga: supplemento **€ 25,00** (art. 890/CL1) - Ordine minimo 300 pz per colore

White front side always  
Scocca interna sempre bianca

PPL FINISHES / Finiture PPL

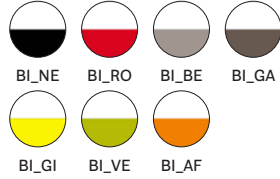

**SAFETY, STRENGTH and DURABILITY TESTS**  
Prove di sicurezza, resistenza e durata  
EN 1728:2012+AC2013  
EN 16139:2013 level 2

PACKING / Imballo



TECHNICAL DETAILS / Dettagli tecnici

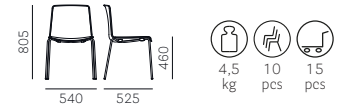

## Tweet 897

One-colour  
Monocolore



SEAT Sedile	BACK Schienale	FRAME Telaio	POWDER COATED Verniciato	CHROMED Cromato
PPL	PPL	Ø 11	<b>€ 106,00</b> AR, VE2, RA2 frame finish excluded Escluso telaio finitura AR, VE2, RA2	<b>€ 106,00</b>

Fire-retardant version available on request: surcharge **€ 25,00** (item 897/CL1) - Minimum order 300 pcs each colour  
Disponibile a richiesta la versione ignifuga: supplemento **€ 25,00** (art. 897/CL1) - Ordine minimo 300 pz per colore

PPL FINISHES / Finiture PPL

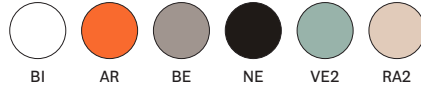

**SAFETY, STRENGTH and DURABILITY TESTS**  
Prove di sicurezza, resistenza e durata  
EN 1728:2012+AC2013  
EN 16139:2013 level 2

PACKING / Imballo



TECHNICAL DETAILS / Dettagli tecnici

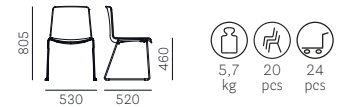

## Tweet 897

Bicolour  
Bicolore



SEAT Sedile	BACK Schienale	FRAME Telaio	POWDER COATED Verniciato	CHROMED Cromato
PPL	PPL	Ø 11	<b>€ 106,00</b> GI frame finish excluded Escluso telaio finitura GI	<b>€ 106,00</b>

Fire-retardant version available on request: surcharge **€ 25,00** (item 897/CL1) - Minimum order 300 pcs each colour  
Disponibile a richiesta la versione ignifuga: supplemento **€ 25,00** (art. 897/CL1) - Ordine minimo 300 pz per colore

White front side always  
Scocca interna sempre bianca

PPL FINISHES / Finiture PPL

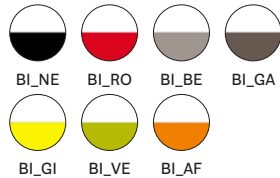

**SAFETY, STRENGTH and DURABILITY TESTS**  
Prove di sicurezza, resistenza e durata  
EN 1728:2012+AC2013  
EN 16139:2013 level 2

PACKING / Imballo



TECHNICAL DETAILS / Dettagli tecnici

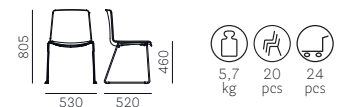

For colours and finishes see at page 362  
Per colori e finiture vedere da pagina 362

## Tweet 894

One-colour  
Monocolore



SEAT Sedile	BACK Schienale	FRAME Telaio	CHROMED Cromato
PPL	PPL	Ø 11	<b>€ 123,00</b>

Fire-retardant version available on request: surcharge **€ 25,00** (item 894/CL1) - Minimum order 300 pcs each colour  
Disponibile a richiesta la versione ignifuga: supplemento **€ 25,00** (art. 894/CL1) - Ordine minimo 300 pz per colore

### PPL FINISHES / Finiture PPL



### PACKING / Imballo



### TECHNICAL DETAILS / Dettagli tecnici

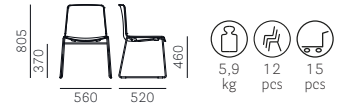

## Tweet 894

Bicolour  
Bicolore



SEAT Sedile	BACK Schienale	FRAME Telaio	CHROMED Cromato
PPL	PPL	Ø 11	<b>€ 123,00</b>

Fire-retardant version available on request: surcharge **€ 25,00** (item 894/CL1) - Minimum order 300 pcs each colour  
Disponibile a richiesta la versione ignifuga: supplemento **€ 25,00** (art. 894/CL1) - Ordine minimo 300 pz per colore

White front side always  
Scocca interna sempre bianca

### PPL FINISHES / Finiture PPL

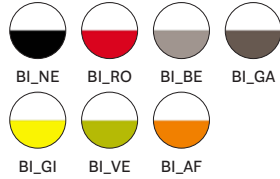

### PACKING / Imballo



### TECHNICAL DETAILS / Dettagli tecnici

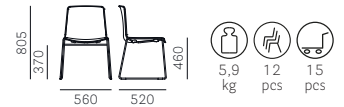

## Tweet 894/TT

Turning tablet only  
Solo tavoletta girevole



TOP Ripiano
<b>€ 94,00</b>

Chromed armrest Ø11 mm  
Bracciolo in tondino Ø11 mm cromato

For item / Per articoli  
894, 894/2

### TABLET FINISH / Finitura tavoletta



### PACKING / Imballo



### TECHNICAL DETAILS / Dettagli tecnici



## Tweet 893

One-colour  
Monocolore



SEAT Sedile	BACK Schienale	FRAME Telaio	BLACK POWDER COATED Verniciato nero
PPL	PPL	Ø 680	<b>€ 187,00</b>

Fire-retardant version available on request: surcharge **€ 25,00** (item 893/CL1) - Minimum order 300 pcs each colour  
Disponibile a richiesta la versione ignifuga: supplemento **€ 25,00** (art. 893/CL1) - Ordine minimo 300 pz per colore

### PPL FINISHES / Finiture PPL

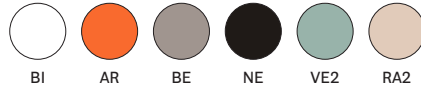

### PACKING / Imballo



### TECHNICAL DETAILS / Dettagli tecnici



## Tweet 893

Bicolour  
Bicolore



SEAT Sedile	BACK Schienale	FRAME Telaio	BLACK POWDER COATED Verniciato nero
PPL	PPL	Ø 680	<b>€ 187,00</b>

Fire-retardant version available on request: surcharge **€ 25,00** (item 893/CL1) - Minimum order 300 pcs each colour  
Disponibile a richiesta la versione ignifuga: supplemento **€ 25,00** (art. 893/CL1) - Ordine minimo 300 pz per colore

White front side always  
Scocca interna sempre bianca

### PPL FINISHES / Finiture PPL

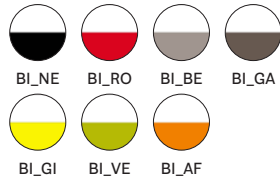

### PACKING / Imballo



### TECHNICAL DETAILS / Dettagli tecnici



## Tweet 893F

One-colour  
Monocolore



SEAT Sedile	BACK Schienale	FRAME Telaio	BLACK POWDER COATED Verniciato nero
PPL	PPL	Ø 680	<b>€ 210,00</b>

Fire-retardant version available on request: surcharge **€ 25,00** (item 893F/CL1) - Minimum order 300 pcs each colour  
Disponibile a richiesta la versione ignifuga: supplemento **€ 25,00** (art. 893F/CL1) - Ordine minimo 300 pz per colore

### PPL FINISHES / Finiture PPL



### PACKING / Imballo



### TECHNICAL DETAILS / Dettagli tecnici



## Tweet 893F

Bicolour  
Bicolore



SEAT Sedile	BACK Schienale	FRAME Telaio	BLACK POWDER COATED Verniciato nero
PPL	PPL	Ø 680	<b>€ 210,00</b>

Fire-retardant version available on request: surcharge **€ 25,00** (item 893F/CL1) - Minimum order 300 pcs each colour  
Disponibile a richiesta la versione ignifuga: supplemento **€ 25,00** (art. 893F/CL1) - Ordine minimo 300 pz per colore

White front side always  
Scocca interna sempre bianca

PPL FINISHES / Finiture PPL

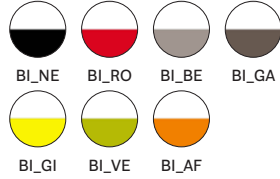

PACKING / Imballo



TECHNICAL DETAILS / Dettagli tecnici



## Tweet 891/3

Gas lift device  
Alzata a gas



SEAT Sedile	BACK Schienale	FRAME Telaio	WHITE/BLACK POWDER COATED Verniciato bianco/nero
PPL	PPL	Ø 750	<b>€ 231,00</b>

Fire-retardant version available on request: surcharge **€ 25,00** (item 891/3/CL1) - Minimum order 300 pcs each colour  
Disponibile a richiesta la versione ignifuga: supplemento **€ 25,00** (art. 891/3/CL1) - Ordine minimo 300 pz per colore

White front side always  
Scocca interna sempre bianca

PPL FINISHES / Finiture PPL



PACKING / Imballo



TECHNICAL DETAILS / Dettagli tecnici



## Tweet 890/2

SOFT



SEAT Sedile	BACK Schienale	FRAME Telaio	POWDER COATED Verniciato	GOLD LACQUERED Laccato oro	CHROMED Cromato	ANTIQUE BRASS Ottone anticato
A	A		<b>€ 238,00</b>	<b>€ 293,00</b>	<b>€ 238,00</b>	<b>€ 304,00</b>
C	C		<b>€ 271,00</b>	<b>€ 326,00</b>	<b>€ 271,00</b>	<b>€ 337,00</b>
D40+D44	D40+D44		<b>€ 310,00</b>	<b>€ 365,00</b>	<b>€ 310,00</b>	<b>€ 376,00</b>
E	E	Ø 14	<b>€ 370,00</b>	<b>€ 425,00</b>	<b>€ 370,00</b>	<b>€ 436,00</b>
G	G		<b>€ 370,00</b>	<b>€ 425,00</b>	<b>€ 370,00</b>	<b>€ 436,00</b>
H*	H*		<b>€ 284,00</b>	<b>€ 339,00</b>	<b>€ 284,00</b>	<b>€ 350,00</b>
TC**	TC**		<b>€ 238,00</b>	<b>€ 293,00</b>	<b>€ 238,00</b>	<b>€ 304,00</b>

\*\*TC = Minimum order 10 pcs each fabric colour  
TC = Ordine minimo 10 pz per colore/tessuto

\*Excluding / Escluso H140+H143

For fabrics see page 367  
Per i tessuti si veda a p. 367

PACKING / Imballo



TECHNICAL DETAILS / Dettagli tecnici

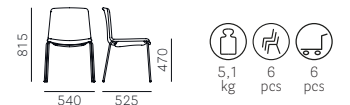

SAFETY, STRENGTH and DURABILITY TESTS  
Prove di sicurezza, resistenza e durata  
EN 1728:2012+AC2013  
EN 16139:2013 level 2

FABRIC REQUIRED / Fabbisogno tessuto  
1 pc: Lin Mtrs 1,20 (h 1,40)

For colours and finishes see at page 362  
Per colori e finiture vedere da pagina 362



## Tweet 897/2

SOFT



SEAT Sedile	BACK Schienale	FRAME Telaio	POWDER COATED Verniciato	GOLD LACQUERED Laccato oro	CHROMED Cromato	ANTIQU BRASS Ottone anticato
A	A		€ 249,00	€ 304,00	€ 249,00	€ 315,00
C	C		€ 282,00	€ 337,00	€ 282,00	€ 348,00
D40÷D44	D40÷D44		€ 321,00	€ 376,00	€ 321,00	€ 387,00
E	E	Ø 11	€ 381,00	€ 436,00	€ 381,00	€ 447,00
G	G		€ 381,00	€ 436,00	€ 381,00	€ 447,00
H*	H*		€ 295,00	€ 350,00	€ 295,00	€ 361,00
TC**	TC**		€ 249,00	€ 304,00	€ 249,00	€ 315,00

\*\*TC = Minimum order 10 pcs each fabric colour  
TC = Ordine minimo 10 pz per colore/tessuto

\*Excluding / Escluso H140+H143

For fabrics see page 367  
Per i tessuti si veda a p. 367

PACKING / Imballo



FABRIC REQUIRED / Fabbisogno tessuto  
1pc: Lin Mtrs 1,20 (h 1,40)

TECHNICAL DETAILS / Dettagli tecnici

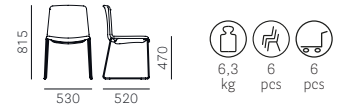

SAFETY, STRENGTH and DURABILITY TESTS  
Prove di sicurezza, resistenza e durata  
EN 1728:2012+AC2013  
EN 16139:2013 level 2

## Tweet 894/2

SOFT



SEAT Sedile	BACK Schienale	FRAME Telaio	CHROMED Cromato
A	A		€ 266,00
C	C		€ 299,00
D40÷D44	D40÷D44		€ 337,00
E	E	Ø 11	€ 398,00
G	G		€ 398,00
H*	H*		€ 312,00
TC**	TC**		€ 266,00

\*\*TC = Minimum order 10 pcs each fabric colour  
TC = Ordine minimo 10 pz per colore/tessuto

\*Excluding / Escluso H140+H143

For fabrics see page 367  
Per i tessuti si veda a p. 367

PACKING / Imballo



FABRIC REQUIRED / Fabbisogno tessuto  
1pc: Lin Mtrs 1,20 (h 1,40)

TECHNICAL DETAILS / Dettagli tecnici

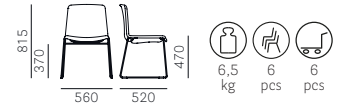

## Tweet 894/TT

Turning tablet only  
Solo tavoletta girevole



TABLET FINISH / Finitura tavoletta

Anti-fingerprint finish  
Finitura anti-impronta

FNPN\_NE



TOP  
Ripiano

€ 94,00  
Chromed armrest Ø11 mm  
Bracciolo in tondino Ø11 mm cromato

For item / Per articoli  
894, 894/2

PACKING / Imballo



TECHNICAL DETAILS / Dettagli tecnici

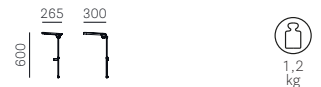

For colours and finishes see at page 362  
Per colori e finiture vedere da pagina 362

## Tweet 893/2

SOFT



SEAT Sedile	BACK Schienale	FRAME Telaio
A	A	Ø 680
C	C	
D40÷D44	D40÷D44	
E	E	
G	G	
H*	H*	
TC**	TC**	

\*\*TC = Minimum order 10 pcs each fabric colour  
TC = Ordine minimo 10 pz per colore/tessuto

\*Excluding / Escluso H140+H143

WHITE/BLACK POWDER COATED  
Verniciato bianco/nero

€ 337,00  
€ 372,00  
€ 412,00  
€ 476,00  
€ 476,00  
€ 385,00  
€ 337,00

For fabrics see page 367  
Per i tessuti si veda a p. 367

PACKING / Imballo



FABRIC REQUIRED / Fabbisogno tessuto  
1pc: Lin Mtrs 1,20 (h 1,40)

TECHNICAL DETAILS / Dettagli tecnici



## Tweet 893F/2

SOFT



SEAT Sedile	BACK Schienale	FRAME Telaio
A	A	Ø 680
C	C	
D40÷D44	D40÷D44	
E	E	
G	G	
H*	H*	
TC**	TC**	

\*\*TC = Minimum order 10 pcs each fabric colour  
TC = Ordine minimo 10 pz per colore/tessuto

\*Excluding / Escluso H140+H143

WHITE/BLACK POWDER COATED  
Verniciato bianco/nero

€ 360,00  
€ 395,00  
€ 435,00  
€ 499,00  
€ 499,00  
€ 408,00  
€ 360,00

For fabrics see page 367  
Per i tessuti si veda a p. 367

PACKING / Imballo



FABRIC REQUIRED / Fabbisogno tessuto  
1pc: Lin Mtrs 1,20 (h 1,40)

TECHNICAL DETAILS / Dettagli tecnici



## Tweet 891/4

SOFT  
Gas lift device  
Alzata a gas



SEAT Sedile	BACK Schienale	FRAME Telaio
A	A	Ø 750
C	C	
D40÷D44	D40÷D44	
E	E	
G	G	
H*	H*	
TC**	TC**	

\*\*TC = Minimum order 10 pcs each fabric colour  
TC = Ordine minimo 10 pz per colore/tessuto

\*Excluding / Escluso H140+H143

WHITE/BLACK POWDER COATED  
Verniciato bianco/nero

€ 382,00  
€ 416,00  
€ 457,00  
€ 520,00  
€ 520,00  
€ 430,00  
€ 382,00

For fabrics see page 367  
Per i tessuti si veda a p. 367

PACKING / Imballo



FABRIC REQUIRED / Fabbisogno tessuto  
1pc: Lin Mtrs 1,20 (h 1,40)

TECHNICAL DETAILS / Dettagli tecnici



## Tweet 895

One-colour  
Monocolore



SEAT Sedile	BACK Schienale	FRAME Telaio	POWDER COATED Verniciato	CHROMED Cromato
PPL	PPL	Ø 14	<b>€ 167,00</b> AR, VE2, RA2 frame finish excluded Escluso telaio finitura AR, VE2, RA2	<b>€ 167,00</b>

Fire-retardant version available on request: surcharge **€ 25,00** (item 895/CL1) - Minimum order 300 pcs each colour  
 Disponibile a richiesta la versione ignifuga: supplemento **€ 25,00** (art. 895/CL1) - Ordine minimo 300 pz per colore

### PPL FINISHES / Finiture PPL

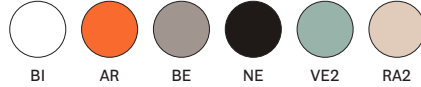

### PACKING / Imballo



### TECHNICAL DETAILS / Dettagli tecnici



## Tweet 895

Bicolour  
Bicolore



SEAT Sedile	BACK Schienale	FRAME Telaio	POWDER COATED Verniciato	CHROMED Cromato
PPL	PPL	Ø 14	<b>€ 167,00</b> GI frame finish excluded Escluso telaio finitura GI	<b>€ 167,00</b>

Fire-retardant version available on request: surcharge **€ 25,00** (item 895/CL1) - Minimum order 300 pcs each colour  
 Disponibile a richiesta la versione ignifuga: supplemento **€ 25,00** (art. 895/CL1) - Ordine minimo 300 pz per colore

White front side always  
 Scocca interna sempre bianca

### PPL FINISHES / Finiture PPL

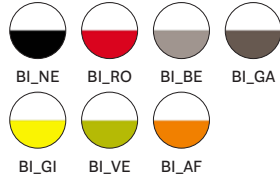

### PACKING / Imballo



### TECHNICAL DETAILS / Dettagli tecnici



## Tweet 898

One-colour  
Monocolore



SEAT Sedile	BACK Schienale	FRAME Telaio	POWDER COATED Verniciato	CHROMED Cromato
PPL	PPL	Ø 11	<b>€ 173,00</b> AR, VE2, RA2 frame finish excluded Escluso telaio finitura AR, VE2, RA2	<b>€ 184,00</b>

Fire-retardant version available on request: surcharge **€ 25,00** (item 898/CL1) - Minimum order 300 pcs each colour  
 Disponibile a richiesta la versione ignifuga: supplemento **€ 25,00** (art. 898/CL1) - Ordine minimo 300 pz per colore

### PPL FINISHES / Finiture PPL



### PACKING / Imballo



### TECHNICAL DETAILS / Dettagli tecnici



For colours and finishes see at page 362  
 Per colori e finiture vedere da pagina 362

## Tweet 898

Bicolour  
Bicolore



SEAT Sedile	BACK Schienale	FRAME Telaio	POWDER COATED Verniciato	CHROMED Cromato
PPL	PPL	Ø 11	<b>€ 173,00</b> GI frame finish excluded Escluso telaio finitura GI	<b>€ 184,00</b>

Fire-retardant version available on request: surcharge **€ 25,00** (item 898/CL1) - Minimum order 300 pcs each colour  
 Disponibile a richiesta la versione ignifuga: supplemento **€ 25,00** (art. 898/CL1) - Ordine minimo 300 pz per colore

White front side always  
 Scocca interna sempre bianca

PPL FINISHES / Finiture PPL

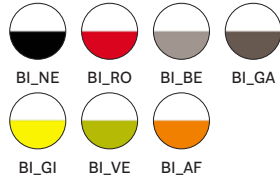

PACKING / Imballo



TECHNICAL DETAILS / Dettagli tecnici

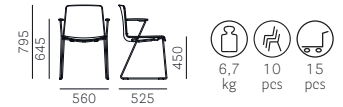

## Tweet 895/2

SOFT



SEAT Sedile	BACK Schienale	FRAME Telaio	POWDER COATED Verniciato	GOLD LACQUERED Laccato oro	CHROMED Cromato	ANTIQU BRASS Ottone anticato
A	A		<b>€ 351,00</b>	<b>€ 406,00</b>	<b>€ 351,00</b>	<b>€ 417,00</b>
C	C		<b>€ 390,00</b>	<b>€ 445,00</b>	<b>€ 390,00</b>	<b>€ 456,00</b>
D40+D44	D40+D44		<b>€ 435,00</b>	<b>€ 490,00</b>	<b>€ 435,00</b>	<b>€ 501,00</b>
E	E	Ø 14	<b>€ 505,00</b>	<b>€ 560,00</b>	<b>€ 505,00</b>	<b>€ 571,00</b>
G	G		<b>€ 505,00</b>	<b>€ 560,00</b>	<b>€ 505,00</b>	<b>€ 571,00</b>
H*	H*		<b>€ 405,00</b>	<b>€ 460,00</b>	<b>€ 405,00</b>	<b>€ 471,00</b>
TC**	TC**		<b>€ 351,00</b>	<b>€ 406,00</b>	<b>€ 351,00</b>	<b>€ 417,00</b>

\*\*TC = Minimum order 10 pcs each fabric colour  
 TC = Ordine minimo 10 pz per colore/tessuto

\*Excluding / Escluso H140+H143

For fabrics see page 367  
 Per i tessuti si veda a p. 367

PACKING / Imballo



FABRIC REQUIRED / Fabbisogno tessuto  
 1pc: Lin Mtrs 1,50 (h 1,40)

TECHNICAL DETAILS / Dettagli tecnici



## Tweet 898/2

SOFT



SEAT Sedile	BACK Schienale	FRAME Telaio	POWDER COATED Verniciato	GOLD LACQUERED Laccato oro	CHROMED Cromato	ANTIQU BRASS Ottone anticato
A	A		<b>€ 358,00</b>	<b>€ 424,00</b>	<b>€ 369,00</b>	<b>€ 435,00</b>
C	C		<b>€ 396,00</b>	<b>€ 462,00</b>	<b>€ 407,00</b>	<b>€ 473,00</b>
D40+D44	D40+D44		<b>€ 442,00</b>	<b>€ 508,00</b>	<b>€ 453,00</b>	<b>€ 519,00</b>
E	E	Ø 11	<b>€ 512,00</b>	<b>€ 578,00</b>	<b>€ 523,00</b>	<b>€ 589,00</b>
G	G		<b>€ 512,00</b>	<b>€ 578,00</b>	<b>€ 523,00</b>	<b>€ 589,00</b>
H*	H*		<b>€ 412,00</b>	<b>€ 478,00</b>	<b>€ 423,00</b>	<b>€ 489,00</b>
TC**	TC**		<b>€ 358,00</b>	<b>€ 424,00</b>	<b>€ 369,00</b>	<b>€ 435,00</b>

\*\*TC = Minimum order 10 pcs each fabric colour  
 TC = Ordine minimo 10 pz per colore/tessuto

\*Excluding / Escluso H140+H143

For fabrics see page 367  
 Per i tessuti si veda a p. 367

PACKING / Imballo



FABRIC REQUIRED / Fabbisogno tessuto  
 1pc: Lin Mtrs 1,50 (h 1,40)

TECHNICAL DETAILS / Dettagli tecnici



For colours and finishes see at page 362  
 Per colori e finiture vedere da pagina 362

## Tweet 892



SEAT Sedile	BACK Schienale	FRAME Telaio	POWDER COATED Verniciato	CHROMED Cromato
PPL	PPL	Ø 14 H650	<b>€ 150,00</b> AR, GI, VE2, RA2 frame finish excluded Escluso telaio finitura AR, GI, VE2, RA2	<b>€ 150,00</b>

Fire-retardant version available on request: surcharge **€ 25,00** (item 892/CL1) - Minimum order 300 pcs each colour  
Disponibile a richiesta la versione ignifuga: supplemento **€ 25,00** (art. 892/CL1) - Ordine minimo 300 pz per colore

### PPL FINISHES / Finiture PPL

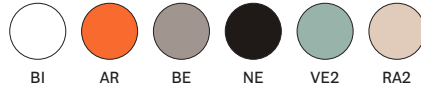

White front side always / Scocca interna sempre bianca



### PACKING / Imballo



### TECHNICAL DETAILS / Dettagli tecnici

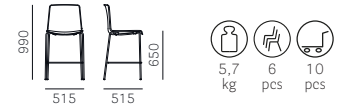

**SAFETY, STRENGTH and DURABILITY TESTS**  
Prove di sicurezza, resistenza e durata  
EN 1728:2012+AC2013  
EN 16139:2013 level 2

## Tweet 896



SEAT Sedile	BACK Schienale	FRAME Telaio	POWDER COATED Verniciato	CHROMED Cromato
PPL	PPL	Ø 14 H750	<b>€ 152,00</b> AR, GI, VE2, RA2 frame finish excluded Escluso telaio finitura AR, GI, VE2, RA2	<b>€ 152,00</b>

Fire-retardant version available on request: surcharge **€ 25,00** (item 896/CL1) - Minimum order 300 pcs each colour  
Disponibile a richiesta la versione ignifuga: supplemento **€ 25,00** (art. 896/CL1) - Ordine minimo 300 pz per colore

### PPL FINISHES / Finiture PPL

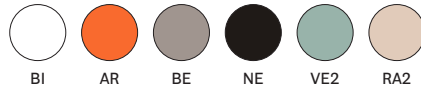

White front side always / Scocca interna sempre bianca



### PACKING / Imballo



### TECHNICAL DETAILS / Dettagli tecnici

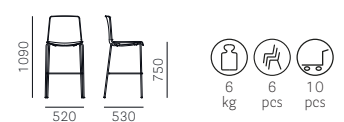

**SAFETY, STRENGTH and DURABILITY TESTS**  
Prove di sicurezza, resistenza e durata  
EN 1728:2012+AC2013  
EN 16139:2013 level 2

## Tweet 899



SEAT Sedile	BACK Schienale	FRAME Telaio	POWDER COATED Verniciato	CHROMED Cromato
PPL	PPL	Ø 12 H750	<b>€ 137,00</b> AR, GI, VE2, RA2 frame finish excluded Escluso telaio finitura AR, GI, VE2, RA2	<b>€ 137,00</b>

Fire-retardant version available on request: surcharge **€ 25,00** (item 899/CL1) - Minimum order 300 pcs each colour  
Disponibile a richiesta la versione ignifuga: supplemento **€ 25,00** (art. 899/CL1) - Ordine minimo 300 pz per colore

### PPL FINISHES / Finiture PPL



White front side always / Scocca interna sempre bianca



### PACKING / Imballo



### TECHNICAL DETAILS / Dettagli tecnici



For colours and finishes see at page 362  
Per colori e finiture vedere da pagina 362

## Tweet 892/2

SOFT



SEAT Sedile	BACK Schienale	FRAME Telaio	POWDER COATED Verniciato	GOLD LACQUERED Laccato oro	CHROMED Cromato	ANTIQU BRASS Ottone anticato
A	A	Ø 14 H660	€ 300,00	€ 357,00	€ 300,00	€ 375,00
C	C		€ 334,00	€ 392,00	€ 334,00	€ 409,00
D40+D44	D40+D44		€ 375,00	€ 433,00	€ 375,00	€ 450,00
E	E		€ 438,00	€ 496,00	€ 438,00	€ 513,00
G	G		€ 438,00	€ 496,00	€ 438,00	€ 513,00
H*	H*		€ 349,00	€ 406,00	€ 349,00	€ 424,00
TC**	TC**		€ 300,00	€ 357,00	€ 300,00	€ 375,00

\*\*TC = Minimum order 10 pcs each fabric colour  
TC = Ordine minimo 10 pz per colore/tessuto

\*Excluding / Escluso H140+H143

For fabrics see page 367  
Per i tessuti si veda a p. 367

PACKING / Imballo



FABRIC REQUIRED / Fabbisogno tessuto  
1pc: Lin Mtrs 1,20 (h 1,40)

TECHNICAL DETAILS / Dettagli tecnici

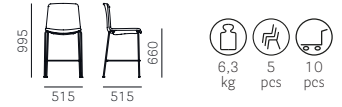

SAFETY, STRENGTH and DURABILITY TESTS  
Prove di sicurezza, resistenza e durata  
EN 1728:2012+AC2013  
EN 16139:2013 level 2

## Tweet 896/2

SOFT



SEAT Sedile	BACK Schienale	FRAME Telaio	POWDER COATED Verniciato	GOLD LACQUERED Laccato oro	CHROMED Cromato	ANTIQU BRASS Ottone anticato
A	A	Ø 14 H760	€ 302,00	€ 360,00	€ 302,00	€ 377,00
C	C		€ 337,00	€ 395,00	€ 337,00	€ 412,00
D40+D44	D40+D44		€ 377,00	€ 435,00	€ 377,00	€ 453,00
E	E		€ 441,00	€ 499,00	€ 441,00	€ 516,00
G	G		€ 441,00	€ 499,00	€ 441,00	€ 516,00
H*	H*		€ 351,00	€ 408,00	€ 351,00	€ 426,00
TC**	TC**		€ 302,00	€ 360,00	€ 302,00	€ 377,00

\*\*TC = Minimum order 10 pcs each fabric colour  
TC = Ordine minimo 10 pz per colore/tessuto

\*Excluding / Escluso H140+H143

For fabrics see page 367  
Per i tessuti si veda a p. 367

PACKING / Imballo



FABRIC REQUIRED / Fabbisogno tessuto  
1pc: Lin Mtrs 1,20 (h 1,40)

TECHNICAL DETAILS / Dettagli tecnici

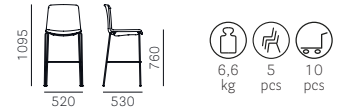

SAFETY, STRENGTH and DURABILITY TESTS  
Prove di sicurezza, resistenza e durata  
EN 1728:2012+AC2013  
EN 16139:2013 level 2

## Tweet 899/2

SOFT



SEAT Sedile	BACK Schienale	FRAME Telaio	POWDER COATED Verniciato	GOLD LACQUERED Laccato oro	CHROMED Cromato	ANTIQU BRASS Ottone anticato
A	A	Ø 12 H760	€ 287,00	€ 345,00	€ 287,00	€ 362,00
C	C		€ 322,00	€ 380,00	€ 322,00	€ 397,00
D40+D44	D40+D44		€ 362,00	€ 420,00	€ 362,00	€ 437,00
E	E		€ 426,00	€ 483,00	€ 426,00	€ 501,00
G	G		€ 426,00	€ 483,00	€ 426,00	€ 501,00
H*	H*		€ 335,00	€ 393,00	€ 335,00	€ 411,00
TC**	TC**		€ 287,00	€ 345,00	€ 287,00	€ 362,00

\*\*TC = Minimum order 10 pcs each fabric colour  
TC = Ordine minimo 10 pz per colore/tessuto

\*Excluding / Escluso H140+H143

For fabrics see page 367  
Per i tessuti si veda a p. 367

PACKING / Imballo



FABRIC REQUIRED / Fabbisogno tessuto  
1pc: Lin Mtrs 1,20 (h 1,40)

TECHNICAL DETAILS / Dettagli tecnici

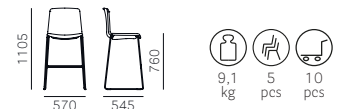

For colours and finishes see at page 362  
Per colori e finiture vedere da pagina 362

## Twig 429



SEAT Sedile	BACK Schienale	FRAME Telaio	OAK Rovere	OAK STAINED ON SAMPLE Rovere tinto campione	BEECH (FS-AN) Faggio
A			€ 223,00	€ 247,00	€ 203,00
C*	RS-W-N1- GC-BI	RS-W-N1- GC-BI	€ 233,00	€ 257,00	€ 212,00
G			€ 257,00	€ 282,00	€ 236,00
H*	FS-AN	FS-AN	€ 246,00	€ 258,00	€ 214,00
P*			€ 293,00	€ 317,00	€ 272,00
TC**	TC	TC	€ 223,00	€ 247,00	€ 203,00
CL**			€ 229,00	€ 253,00	€ 209,00

\*\*TC/CL = Minimum order 10 pcs each fabric colour  
TC/CL = Ordine minimo 10 pz per colore/tessuto

\* Excluding / Escluso C36+C39, H140+H143, PBS-PCO-PMS-PVE

### FINISHES / Finiture

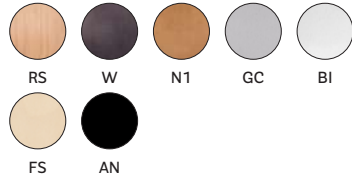

**SAFETY, STRENGTH and DURABILITY TESTS**  
Prove di sicurezza, resistenza e durata  
EN 1728:2000

For fabrics see page 367  
Per i tessuti si veda a p. 367

### PACKING / Imballo



**FABRIC REQUIRED / Fabbisogno tessuto**  
1pc: Lin Mtrs 0,30 (h 1,40)

### TECHNICAL DETAILS / Dettagli tecnici

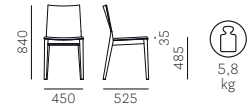

## Twig 429/2



SEAT Sedile	BACK Schienale	FRAME Telaio	OAK Rovere	OAK STAINED ON SAMPLE Rovere tinto campione	BEECH (FS-AN) Faggio
A			€ 241,00	€ 266,00	€ 221,00
C*	RS-W-N1- GC-BI	RS-W-N1- GC-BI	€ 251,00	€ 275,00	€ 230,00
G			€ 275,00	€ 300,00	€ 255,00
H*	FS-AN	FS-AN	€ 252,00	€ 277,00	€ 232,00
P*			€ 311,00	€ 335,00	€ 290,00
TC**	TC	TC	€ 241,00	€ 266,00	€ 221,00
CL**			€ 247,00	€ 272,00	€ 227,00

\*\*TC/CL = Minimum order 10 pcs each fabric colour  
TC/CL = Ordine minimo 10 pz per colore/tessuto

\* Excluding / Escluso C36+C39, H140+H143, PBS-PCO-PMS-PVE

### FINISHES / Finiture



**SAFETY, STRENGTH and DURABILITY TESTS**  
Prove di sicurezza, resistenza e durata  
EN 1728:2000

For fabrics see page 367  
Per i tessuti si veda a p. 367

### PACKING / Imballo



**FABRIC REQUIRED / Fabbisogno tessuto**  
1pc: Lin Mtrs 0,30 (h 1,40)

### TECHNICAL DETAILS / Dettagli tecnici

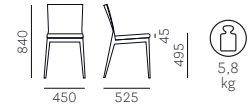

## TX 4403F

S\_TX



SEAT Sedile	FRAME Telaio	BRUSHED S/STEEL Inox satinato	POLISHED S/STEEL Inox lucidato
Frame only / Solo telaio		€ 130,00	€ 145,00
A	Ø 400	€ 173,00	€ 188,00
C*		€ 185,00	€ 200,00
G		€ 219,00	€ 234,00
H*		€ 187,00	€ 202,00
P*		€ 231,00	€ 246,00
TC**		€ 173,00	€ 188,00
CL**		€ 179,00	€ 194,00
PG		€ 152,00	€ 167,00

\*\*TC/CL = Minimum order 10 pcs each fabric colour  
TC/CL = Ordine minimo 10 pz per colore/tessuto

\* Excluding / Escluso C36+C39, H140+H143, PBS-PCO-PMS-PVE

For fabrics see page 367  
Per i tessuti si veda a p. 367

### PACKING / Imballo

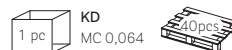

**FABRIC REQUIRED / Fabbisogno tessuto**  
1pc: Lin Mtrs 0,35 (h 1,40)

### TECHNICAL DETAILS / Dettagli tecnici



## TX 4403G

S\_TX



SEAT Sedile	FRAME Telaio	BRUSHED S/STEEL Inox satinato	POLISHED S/STEEL Inox lucidato
Frame only / Solo telaio		€ 167,00	€ 182,00
A		€ 210,00	€ 225,00
C*		€ 222,00	€ 237,00
G		€ 256,00	€ 271,00
H*	Ø 400	€ 224,00	€ 239,00
P*		€ 268,00	€ 283,00
TC**		€ 210,00	€ 225,00
CL**		€ 216,00	€ 231,00
PG		€ 189,00	€ 204,00

\*\*TC/CL = Minimum order 10 pcs each fabric colour  
TC/CL = Ordine minimo 10 pz per colore/tessuto

\*Excluding / Escluso C36+C39, H140+H143, PBS-PCO-PMS-PVE

For fabrics see page 367  
Per i tessuti si veda a p. 367

PACKING / Imballo



FABRIC REQUIRED / Fabbisogno tessuto  
1pc: Lin Mtrs 0,35 (h 1,40)

TECHNICAL DETAILS / Dettagli tecnici



## TX 4405F

S\_TX



SEAT Sedile	FRAME Telaio	BRUSHED S/STEEL Inox satinato
Frame only / Solo telaio		€ 236,00
A		€ 279,00
C*		€ 291,00
G		€ 325,00
H*	Ø 400	€ 293,00
P*		€ 337,00
TC**		€ 279,00
CL**		€ 285,00
PG		€ 258,00

\*\*TC/CL = Minimum order 10 pcs each fabric colour  
TC/CL = Ordine minimo 10 pz per colore/tessuto

\*Excluding / Escluso C36+C39, H140+H143, PBS-PCO-PMS-PVE

For fabrics see page 367  
Per i tessuti si veda a p. 367

PACKING / Imballo



FABRIC REQUIRED / Fabbisogno tessuto  
1pc: Lin Mtrs 0,35 (h 1,40)

TECHNICAL DETAILS / Dettagli tecnici

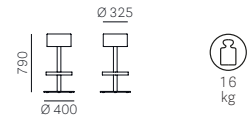

## TX 4405G

S\_TX



SEAT Sedile	FRAME Telaio	BRUSHED S/STEEL Inox satinato
Frame only / Solo telaio		€ 274,00
A		€ 317,00
C*		€ 329,00
G		€ 363,00
H*	Ø 400	€ 331,00
P*		€ 375,00
TC**		€ 317,00
CL**		€ 323,00
PG		€ 296,00

\*\*TC/CL = Minimum order 10 pcs each fabric colour  
TC/CL = Ordine minimo 10 pz per colore/tessuto

\*Excluding / Escluso C36+C39, H140+H143, PBS-PCO-PMS-PVE

For fabrics see page 367  
Per i tessuti si veda a p. 367

PACKING / Imballo



FABRIC REQUIRED / Fabbisogno tessuto  
1pc: Lin Mtrs 0,35 (h 1,40)

TECHNICAL DETAILS / Dettagli tecnici

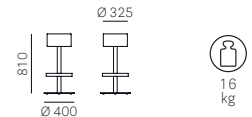



## TX 4407



SEAT Sedile	FRAME Telaio	BRUSHED S/STEEL Inox satinato
RS-W	Ø 400	€ 335,00
EB-ZB		

### FINISHES / Finiture

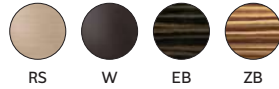

### PACKING / Imballo

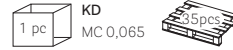

### TECHNICAL DETAILS / Dettagli tecnici

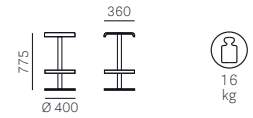

## TX 4407F



SEAT Sedile	FRAME Telaio	BRUSHED S/STEEL Inox satinato
RS-W	Ø 400	€ 298,00
EB-ZB		

### FINISHES / Finiture

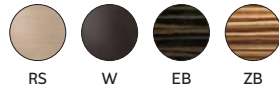

### PACKING / Imballo



### TECHNICAL DETAILS / Dettagli tecnici

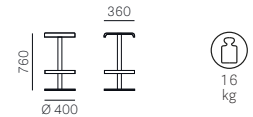

## Vic 655

ABS shell below cover  
Guscio sottoscocca in ABS



SEAT Sedile	BACK Schienale	FRAME Telaio	ASH Frassino
A	A	FR-N1 GC-AN	€ 631,00
C*	C*		€ 663,00
D40÷D44	D40÷D44		€ 701,00
E	E		€ 816,00
G	G		€ 759,00
H*	H*		€ 676,00
P*	P*		€ 869,00
PF**	PF**		€ 904,00
TC***	TC***		€ 631,00
CL***	CL***		€ 660,00

\*Excluding / Escluso C36+C39, H120+H127, H140+H143, PBS-PCO-PMS-PVE

\*\*Perforated mid-grain leather (inner part of the back, upper part of the seat)  
Pelle forata (parte interna dello schienale e parte superiore del sedile)

\*\*\*TC/CL = Minimum order 10 pcs each fabric colour. Feasibility to be approved  
TC/CL = Ordine minimo 10 pz per colore/tessuto. Fattibilità da valutare

### WOODEN FINISHES / Finiture legno



### ABS SHELL BELOW COVER / Guscio sottoscocca in ABS



NE  
For fabrics see page 367  
Per i tessuti si veda a p. 367

### PACKING / Imballo



### FABRIC REQUIRED / Fabbisogno tessuto

1 pc: Lin Mtrs 1,20 (h 1,40)

### TECHNICAL DETAILS / Dettagli tecnici

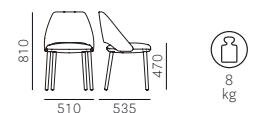

SAFETY, STRENGTH and DURABILITY TESTS  
Prove di sicurezza, resistenza e durata  
EN 1728:2012+AC2013  
EN 16139:2013 level 2



## Vic Metal 656

Upholstered shell below cover  
Guscio sottoscocca imbottito

SEAT Sedile	BACK Schienale	FRAME Telaio	POWDER COATED Verniciato	SATINIZED Satinato	BRUSHED BRONZE Bronzo satinato	ANTIQU BRASS Ottone antico	TITANIUM Titanio
A	A	Ø 25	€ 659,00	€ 703,00	€ 703,00	€ 703,00	€ 703,00
C*	C*		€ 699,00	€ 743,00	€ 743,00	€ 743,00	€ 743,00
D40÷D44	D40÷D44		€ 747,00	€ 791,00	€ 791,00	€ 791,00	€ 791,00
E	E		€ 877,00	€ 921,00	€ 921,00	€ 921,00	€ 921,00
G	G		€ 821,00	€ 865,00	€ 865,00	€ 865,00	€ 865,00
H*	H*		€ 715,00	€ 759,00	€ 759,00	€ 759,00	€ 759,00
P*	P*		€ 937,00	€ 981,00	€ 981,00	€ 981,00	€ 981,00
PF**	PF**		€ 971,00	€ 1.015,00	€ 1.015,00	€ 1.015,00	€ 1.015,00
TC***	TC***		€ 659,00	€ 703,00	€ 703,00	€ 703,00	€ 703,00
CL***	CL***		€ 689,00	€ 733,00	€ 733,00	€ 733,00	€ 733,00

\*Excluding / Escluso C36+C39, H120+H127, H140+H143, PBS-PCO-PMS-PVE

\*\*Perforated mid-grain leather (inner part of the back, upper part of the seat)  
Pelle forata (parte interna dello schienale e parte superiore del sedile)For fabrics see page 367  
Per i tessuti si veda a p. 367\*\*\*TC/CL = Minimum order 10 pcs each fabric colour. Feasibility to be approved  
TC/CL = Ordine minimo 10 pz per colore/tessuto. Fattibilità da valutare

PACKING / Imballo

TECHNICAL DETAILS / Dettagli tecnici

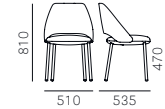
FABRIC REQUIRED / Fabbisogno tessuto  
1pc: Lin Mtrs 1,80 (h 1,40)

## Vic Metal 657

ABS shell below cover  
Guscio sottoscocca in ABS

SEAT Sedile	BACK Schienale	FRAME Telaio	POWDER COATED Verniciato	SATINIZED Satinato	BRUSHED BRONZE Bronzo satinato	ANTIQU BRASS Ottone antico	TITANIUM Titanio
A	A	Ø 25	€ 609,00	€ 653,00	€ 653,00	€ 653,00	€ 653,00
C*	C*		€ 641,00	€ 685,00	€ 685,00	€ 685,00	€ 685,00
D40÷D44	D40÷D44		€ 679,00	€ 723,00	€ 723,00	€ 723,00	€ 723,00
E	E		€ 794,00	€ 838,00	€ 838,00	€ 838,00	€ 838,00
G	G		€ 737,00	€ 781,00	€ 781,00	€ 781,00	€ 781,00
H*	H*		€ 654,00	€ 698,00	€ 698,00	€ 698,00	€ 698,00
P*	P*		€ 847,00	€ 891,00	€ 891,00	€ 891,00	€ 891,00
PF**	PF**		€ 882,00	€ 926,00	€ 926,00	€ 926,00	€ 926,00
TC***	TC***		€ 609,00	€ 653,00	€ 653,00	€ 653,00	€ 653,00
CL***	CL***		€ 638,00	€ 682,00	€ 682,00	€ 682,00	€ 682,00

\*Excluding / Escluso C36+C39, H120+H127, H140+H143, PBS-PCO-PMS-PVE

\*\*Perforated mid-grain leather (inner part of the back, upper part of the seat)  
Pelle forata (parte interna dello schienale e parte superiore del sedile)

ABS SHELL BELOW COVER / Guscio sottoscocca in ABS

\*\*\*TC/CL = Minimum order 10 pcs each fabric colour. Feasibility to be approved  
TC/CL = Ordine minimo 10 pz per colore/tessuto. Fattibilità da valutare

PACKING / Imballo

TECHNICAL DETAILS / Dettagli tecnici

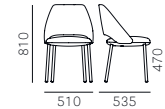

NE

For fabrics see page 367  
Per i tessuti si veda a p. 367FABRIC REQUIRED / Fabbisogno tessuto  
1pc: Lin Mtrs 1,20 (h 1,40)

## Vic 645

ABS shell below cover  
Guscio sottoscocca in ABS

SEAT Sedile	BACK Schienale	FRAME Telaio	ASH Frassino
A	A	FR-N1 GC-AN	€ 676,00
C*	C*		€ 712,00
D40÷D44	D40÷D44		€ 755,00
E	E		€ 880,00
G	G		€ 821,00
H*	H*		€ 726,00
P*	P*		€ 972,00
PF**	PF**		€ 1.018,00
TC***	TC***		€ 676,00
CL***	CL***		€ 709,00

\*Excluding / Escluso C36+C39, H120+H127, H140+H143, PBS-PCO-PMS-PVE

\*\*Perforated mid-grain leather (inner part of the back, upper part of the seat)  
Pelle forata (parte interna dello schienale e parte superiore del sedile)

FINISHES / Finiture

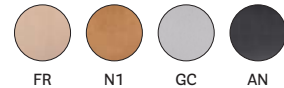

ABS SHELL BELOW COVER / Guscio sottoscocca in ABS

\*\*\*TC/CL = Minimum order 10 pcs each fabric colour. Feasibility to be approved  
TC/CL = Ordine minimo 10 pz per colore/tessuto. Fattibilità da valutare

PACKING / Imballo

TECHNICAL DETAILS / Dettagli tecnici

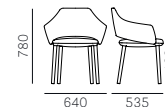
FABRIC REQUIRED / Fabbisogno tessuto  
1pc: Lin Mtrs 1,20 (h 1,40)SAFETY, STRENGTH and DURABILITY TESTS  
Prove di sicurezza, resistenza e durata  
EN 1728:2012+AC2013  
EN 16139:2013 level 2

NE

For fabrics see page 367  
Per i tessuti si veda a p. 367For colours and finishes see at page 362  
Per colori e finiture vedere da pagina 362

## Vic Metal 646

Upholstered shell below cover  
Guscio sottoscocca imbottito



SEAT Sedile	BACK Schienale	FRAME Telaio	POWDER COATED Verniciato	SATINIZED Satinato	BRUSHED BRONZE Bronzo satinato	ANTIQU BRASS Ottone antico	TITANIUM Titanio
A	A	Ø 25	€ 704,00	€ 748,00	€ 748,00	€ 748,00	€ 748,00
C*	C*		€ 748,00	€ 792,00	€ 792,00	€ 792,00	€ 792,00
D40+D44	D40+D44		€ 801,00	€ 845,00	€ 845,00	€ 845,00	€ 845,00
E	E		€ 942,00	€ 986,00	€ 986,00	€ 986,00	€ 986,00
G	G		€ 883,00	€ 927,00	€ 927,00	€ 927,00	€ 927,00
H*	H*		€ 766,00	€ 810,00	€ 810,00	€ 810,00	€ 810,00
P*	P*		€ 1.039,00	€ 1.083,00	€ 1.083,00	€ 1.083,00	€ 1.083,00
PF**	PF**		€ 1.085,00	€ 1.129,00	€ 1.129,00	€ 1.129,00	€ 1.129,00
TC***	TC***		€ 704,00	€ 748,00	€ 748,00	€ 748,00	€ 748,00
CL***	CL***		€ 737,00	€ 781,00	€ 781,00	€ 781,00	€ 781,00

\*Excluding / Escluso C36+C39, H120+H127, H140+H143, PBS-PCO-PMS-PVE

\*\*Perforated mid-grain leather (inner part of the back, upper part of the seat)  
Pelle forata (parte interna dello schienale e parte superiore del sedile)

For fabrics see page 367  
Per i tessuti si veda a p. 367

\*\*\*TC/CL = Minimum order 10 pcs each fabric colour. Feasibility to be approved  
TC/CL = Ordine minimo 10 pz per colore/tessuto. Fattibilità da valutare

PACKING / Imballo

TECHNICAL DETAILS / Dettagli tecnici



FABRIC REQUIRED / Fabbisogno tessuto  
1pc: Lin Mtrs 1,90 (h 1,40)

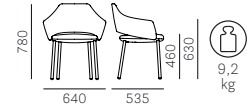

## Vic Metal 647

ABS shell below cover  
Guscio sottoscocca in ABS



SEAT Sedile	BACK Schienale	FRAME Telaio	POWDER COATED Verniciato	SATINIZED Satinato	BRUSHED BRONZE Bronzo satinato	ANTIQU BRASS Ottone antico	TITANIUM Titanio
A	A	Ø 25	€ 654,00	€ 698,00	€ 698,00	€ 698,00	€ 698,00
C*	C*		€ 690,00	€ 734,00	€ 734,00	€ 734,00	€ 734,00
D40+D44	D40+D44		€ 733,00	€ 777,00	€ 777,00	€ 777,00	€ 777,00
E	E		€ 858,00	€ 902,00	€ 902,00	€ 902,00	€ 902,00
G	G		€ 799,00	€ 843,00	€ 843,00	€ 843,00	€ 843,00
H*	H*		€ 704,00	€ 748,00	€ 748,00	€ 748,00	€ 748,00
P*	P*		€ 950,00	€ 994,00	€ 994,00	€ 994,00	€ 994,00
PF**	PF**		€ 996,00	€ 1.040,00	€ 1.040,00	€ 1.040,00	€ 1.040,00
TC***	TC***		€ 654,00	€ 698,00	€ 698,00	€ 698,00	€ 698,00
CL***	CL***		€ 687,00	€ 731,00	€ 731,00	€ 731,00	€ 731,00

\*Excluding / Escluso C36+C39, H120+H127, H140+H143, PBS-PCO-PMS-PVE

\*\*Perforated mid-grain leather (inner part of the back, upper part of the seat)  
Pelle forata (parte interna dello schienale e parte superiore del sedile)

ABS SHELL BELOW COVER / Guscio sottoscocca in ABS

\*\*\*TC/CL = Minimum order 10 pcs each fabric colour. Feasibility to be approved  
TC/CL = Ordine minimo 10 pz per colore/tessuto. Fattibilità da valutare

PACKING / Imballo

TECHNICAL DETAILS / Dettagli tecnici



FABRIC REQUIRED / Fabbisogno tessuto  
1pc: Lin Mtrs 1,20 (h 1,40)

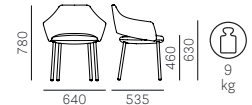

## Vic Metal 659

Upholstered shell below cover  
Guscio sottoscocca imbottito



SEAT Sedile	BACK Schienale	FRAME Telaio	POWDER COATED Verniciato	SATINIZED Satinato	BRUSHED BRONZE Bronzo satinato	ANTIQU BRASS Ottone antico	TITANIUM Titanio
A	A	H660	€ 714,00	€ 792,00	€ 792,00	€ 792,00	€ 792,00
C*	C*		€ 754,00	€ 832,00	€ 832,00	€ 832,00	€ 832,00
D40+D44	D40+D44		€ 802,00	€ 880,00	€ 880,00	€ 880,00	€ 880,00
E	E		€ 932,00	€ 1.010,00	€ 1.010,00	€ 1.010,00	€ 1.010,00
G	G		€ 876,00	€ 954,00	€ 954,00	€ 954,00	€ 954,00
H*	H*		€ 770,00	€ 849,00	€ 849,00	€ 849,00	€ 849,00
P*	P*		€ 992,00	€ 1.070,00	€ 1.070,00	€ 1.070,00	€ 1.070,00
PF**	PF**		€ 1.026,00	€ 1.104,00	€ 1.104,00	€ 1.104,00	€ 1.104,00
TC***	TC***		€ 714,00	€ 792,00	€ 792,00	€ 792,00	€ 792,00
CL***	CL***		€ 744,00	€ 822,00	€ 822,00	€ 822,00	€ 822,00

\*Excluding / Escluso C36+C39, H120+H127, H140+H143, PBS-PCO-PMS-PVE

\*\*Perforated mid-grain leather (inner part of the back, upper part of the seat)  
Pelle forata (parte interna dello schienale e parte superiore del sedile)

For fabrics see page 367  
Per i tessuti si veda a p. 367

\*\*\*TC/CL = Minimum order 10 pcs each fabric colour. Feasibility to be approved  
TC/CL = Ordine minimo 10 pz per colore/tessuto. Fattibilità da valutare

PACKING / Imballo

TECHNICAL DETAILS / Dettagli tecnici



FABRIC REQUIRED / Fabbisogno tessuto  
1pc: Lin Mtrs 1,80 (h 1,40)



For colours and finishes see at page 362  
Per colori e finiture vedere da pagina 362

## Vic Metal 659/2

ABS shell below cover  
Guscio sottoscocca in ABS

SEAT Sedile	BACK Schienale	FRAME Telaio	POWDER COATED Verniciato	SATINIZED Satinato	BRUSHED BRONZE Bronzo satinato	ANTIQU BRASS Ottone anticato	TITANIUM Titanio
A	A	H660	€ 664,00	€ 742,00	€ 742,00	€ 742,00	€ 742,00
C*	C*		€ 696,00	€ 774,00	€ 774,00	€ 774,00	€ 774,00
D40+D44	D40+D44		€ 734,00	€ 812,00	€ 812,00	€ 812,00	€ 812,00
E	E		€ 849,00	€ 927,00	€ 927,00	€ 927,00	€ 927,00
G	G		€ 792,00	€ 871,00	€ 871,00	€ 871,00	€ 871,00
H*	H*		€ 709,00	€ 787,00	€ 787,00	€ 787,00	€ 787,00
P*	P*		€ 902,00	€ 981,00	€ 981,00	€ 981,00	€ 981,00
PF**	PF**		€ 937,00	€ 1.015,00	€ 1.015,00	€ 1.015,00	€ 1.015,00
TC***	TC***		€ 664,00	€ 742,00	€ 742,00	€ 742,00	€ 742,00
CL***	CL***		€ 693,00	€ 772,00	€ 772,00	€ 772,00	€ 772,00

\*Excluding / Escluso C36+C39, H120+H127, H140+H143, PBS-PCO-PMS-PVE

\*\*Perforated mid-grain leather (inner part of the back, upper part of the seat)  
Pelle forata (parte interna dello schienale e parte superiore del sedile)\*\*\*TC/CL = Minimum order 10 pcs each fabric colour. Feasibility to be approved  
TC/CL = Ordine minimo 10 pz per colore/tessuto. Fattibilità da valutare

ABS SHELL BELOW COVER / Guscio sottoscocca in ABS

PACKING / Imballo

TECHNICAL DETAILS / Dettagli tecnici



NE

For fabrics see page 367  
Per i tessuti si veda a p. 367FABRIC REQUIRED / Fabbisogno tessuto  
1pc: Lin Mtrs 1,20 (h 1,40)

## Vic Metal 658

Upholstered shell below cover  
Guscio sottoscocca imbottito

SEAT Sedile	BACK Schienale	FRAME Telaio	POWDER COATED Verniciato	SATINIZED Satinato	BRUSHED BRONZE Bronzo satinato	ANTIQU BRASS Ottone anticato	TITANIUM Titanio
A	A	H760	€ 720,00	€ 803,00	€ 803,00	€ 803,00	€ 803,00
C*	C*		€ 759,00	€ 843,00	€ 843,00	€ 843,00	€ 843,00
D40+D44	D40+D44		€ 808,00	€ 891,00	€ 891,00	€ 891,00	€ 891,00
E	E		€ 938,00	€ 1.021,00	€ 1.021,00	€ 1.021,00	€ 1.021,00
G	G		€ 882,00	€ 965,00	€ 965,00	€ 965,00	€ 965,00
H*	H*		€ 776,00	€ 860,00	€ 860,00	€ 860,00	€ 860,00
P*	P*		€ 997,00	€ 1.081,00	€ 1.081,00	€ 1.081,00	€ 1.081,00
PF**	PF**		€ 1.031,00	€ 1.115,00	€ 1.115,00	€ 1.115,00	€ 1.115,00
TC***	TC***		€ 720,00	€ 803,00	€ 803,00	€ 803,00	€ 803,00
CL***	CL***		€ 750,00	€ 833,00	€ 833,00	€ 833,00	€ 833,00

\*Excluding / Escluso C36+C39, H120+H127, H140+H143, PBS-PCO-PMS-PVE

\*\*Perforated mid-grain leather (inner part of the back, upper part of the seat)  
Pelle forata (parte interna dello schienale e parte superiore del sedile)\*\*\*TC/CL = Minimum order 10 pcs each fabric colour. Feasibility to be approved  
TC/CL = Ordine minimo 10 pz per colore/tessuto. Fattibilità da valutareFor fabrics see page 367  
Per i tessuti si veda a p. 367

PACKING / Imballo

TECHNICAL DETAILS / Dettagli tecnici

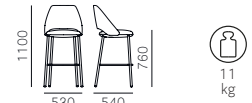
FABRIC REQUIRED / Fabbisogno tessuto  
1pc: Lin Mtrs 1,80 (h 1,40)

## Vic Metal 658/2

ABS shell below cover  
Guscio sottoscocca in ABS

SEAT Sedile	BACK Schienale	FRAME Telaio	POWDER COATED Verniciato	SATINIZED Satinato	BRUSHED BRONZE Bronzo satinato	ANTIQU BRASS Ottone anticato	TITANIUM Titanio
A	A	H760	€ 669,00	€ 753,00	€ 753,00	€ 753,00	€ 753,00
C*	C*		€ 701,00	€ 785,00	€ 785,00	€ 785,00	€ 785,00
D40+D44	D40+D44		€ 740,00	€ 823,00	€ 823,00	€ 823,00	€ 823,00
E	E		€ 854,00	€ 938,00	€ 938,00	€ 938,00	€ 938,00
G	G		€ 798,00	€ 882,00	€ 882,00	€ 882,00	€ 882,00
H*	H*		€ 714,00	€ 798,00	€ 798,00	€ 798,00	€ 798,00
P*	P*		€ 908,00	€ 992,00	€ 992,00	€ 992,00	€ 992,00
PF**	PF**		€ 942,00	€ 1.026,00	€ 1.026,00	€ 1.026,00	€ 1.026,00
TC***	TC***		€ 669,00	€ 753,00	€ 753,00	€ 753,00	€ 753,00
CL***	CL***		€ 699,00	€ 783,00	€ 783,00	€ 783,00	€ 783,00

\*Excluding / Escluso C36+C39, H120+H127, H140+H143, PBS-PCO-PMS-PVE

\*\*Perforated mid-grain leather (inner part of the back, upper part of the seat)  
Pelle forata (parte interna dello schienale e parte superiore del sedile)\*\*\*TC/CL = Minimum order 10 pcs each fabric colour. Feasibility to be approved  
TC/CL = Ordine minimo 10 pz per colore/tessuto. Fattibilità da valutare

ABS SHELL BELOW COVER / Guscio sottoscocca in ABS

PACKING / Imballo

TECHNICAL DETAILS / Dettagli tecnici



NE

For fabrics see page 367  
Per i tessuti si veda a p. 367FABRIC REQUIRED / Fabbisogno tessuto  
1pc: Lin Mtrs 1,20 (h 1,40)For colours and finishes see at page 362  
Per colori e finiture vedere da pagina 362

## Vic Metal 649

Upholstered shell below cover  
Guscio sottoscocca imbottito



SEAT Sedile	BACK Schienale	FRAME Telaio	POWDER COATED Verniciato	SATINIZED Satinato	BRUSHED BRONZE Bronzo satinato	ANTIQU BRASS Ottone anticato	TITANIUM Titanio
A	A	H650	€ 759,00	€ 838,00	€ 838,00	€ 838,00	€ 838,00
C*	C*		€ 803,00	€ 882,00	€ 882,00	€ 882,00	€ 882,00
D40÷D44	D40÷D44		€ 856,00	€ 934,00	€ 934,00	€ 934,00	€ 934,00
E	E		€ 997,00	€ 1.075,00	€ 1.075,00	€ 1.075,00	€ 1.075,00
G	G		€ 938,00	€ 1.016,00	€ 1.016,00	€ 1.016,00	€ 1.016,00
H*	H*		€ 821,00	€ 899,00	€ 899,00	€ 899,00	€ 899,00
P*	P*		€ 1.094,00	€ 1.172,00	€ 1.172,00	€ 1.172,00	€ 1.172,00
PF**	PF**		€ 1.140,00	€ 1.218,00	€ 1.218,00	€ 1.218,00	€ 1.218,00
TC***	TC***		€ 759,00	€ 838,00	€ 838,00	€ 838,00	€ 838,00
CL***	CL***		€ 792,00	€ 871,00	€ 871,00	€ 871,00	€ 871,00

\*Excluding / Escluso C36+C39, H120+H127, H140+H143, PBS-PCO-PMS-PVE

\*\*Perforated mid-grain leather (inner part of the back, upper part of the seat)  
Pelle forata (parte interna dello schienale e parte superiore del sedile)

For fabrics see page 367  
Per i tessuti si veda a p. 367

\*\*\*TC/CL = Minimum order 10 pcs each fabric colour. Feasibility to be approved  
TC/CL = Ordine minimo 10 pz per colore/tessuto. Fattibilità da valutare

PACKING / Imballo

TECHNICAL DETAILS / Dettagli tecnici



FABRIC REQUIRED / Fabbisogno tessuto  
1pc: Lin Mtrs 1,90 (h 1,40)



SAFETY, STRENGTH and DURABILITY TESTS  
Prove di sicurezza, resistenza e durata  
EN 1728:2012+AC2013  
EN 16139:2013 level 2

## Vic Metal 649/2

ABS shell below cover  
Guscio sottoscocca in ABS



SEAT Sedile	BACK Schienale	FRAME Telaio	POWDER COATED Verniciato	SATINIZED Satinato	BRUSHED BRONZE Bronzo satinato	ANTIQU BRASS Ottone anticato	TITANIUM Titanio
A	A	H650	€ 709,00	€ 787,00	€ 787,00	€ 787,00	€ 787,00
C*	C*		€ 745,00	€ 823,00	€ 823,00	€ 823,00	€ 823,00
D40÷D44	D40÷D44		€ 788,00	€ 866,00	€ 866,00	€ 866,00	€ 866,00
E	E		€ 913,00	€ 992,00	€ 992,00	€ 992,00	€ 992,00
G	G		€ 854,00	€ 932,00	€ 932,00	€ 932,00	€ 932,00
H*	H*		€ 759,00	€ 838,00	€ 838,00	€ 838,00	€ 838,00
P*	P*		€ 1.005,00	€ 1.083,00	€ 1.083,00	€ 1.083,00	€ 1.083,00
PF**	PF**		€ 1.051,00	€ 1.129,00	€ 1.129,00	€ 1.129,00	€ 1.129,00
TC***	TC***		€ 709,00	€ 787,00	€ 787,00	€ 787,00	€ 787,00
CL***	CL***		€ 742,00	€ 820,00	€ 820,00	€ 820,00	€ 820,00

\*Excluding / Escluso C36+C39, H120+H127, H140+H143, PBS-PCO-PMS-PVE

\*\*Perforated mid-grain leather (inner part of the back, upper part of the seat)  
Pelle forata (parte interna dello schienale e parte superiore del sedile)

ABS SHELL BELOW COVER / Guscio sottoscocca in ABS

\*\*\*TC/CL = Minimum order 10 pcs each fabric colour. Feasibility to be approved  
TC/CL = Ordine minimo 10 pz per colore/tessuto. Fattibilità da valutare

PACKING / Imballo

TECHNICAL DETAILS / Dettagli tecnici



FABRIC REQUIRED / Fabbisogno tessuto  
1pc: Lin Mtrs 1,20 (h 1,40)



SAFETY, STRENGTH and DURABILITY TESTS  
Prove di sicurezza, resistenza e durata  
EN 1728:2012+AC2013  
EN 16139:2013 level 2

## Vic Metal 648

Upholstered shell below cover  
Guscio sottoscocca imbottito



SEAT Sedile	BACK Schienale	FRAME Telaio	POWDER COATED Verniciato	SATINIZED Satinato	BRUSHED BRONZE Bronzo satinato	ANTIQU BRASS Ottone anticato	TITANIUM Titanio
A	A	H750	€ 765,00	€ 849,00	€ 849,00	€ 849,00	€ 849,00
C*	C*		€ 809,00	€ 893,00	€ 893,00	€ 893,00	€ 893,00
D40÷D44	D40÷D44		€ 862,00	€ 945,00	€ 945,00	€ 945,00	€ 945,00
E	E		€ 1.003,00	€ 1.086,00	€ 1.086,00	€ 1.086,00	€ 1.086,00
G	G		€ 943,00	€ 1.027,00	€ 1.027,00	€ 1.027,00	€ 1.027,00
H*	H*		€ 827,00	€ 910,00	€ 910,00	€ 910,00	€ 910,00
P*	P*		€ 1.099,00	€ 1.183,00	€ 1.183,00	€ 1.183,00	€ 1.183,00
PF**	PF**		€ 1.146,00	€ 1.229,00	€ 1.229,00	€ 1.229,00	€ 1.229,00
TC***	TC***		€ 765,00	€ 849,00	€ 849,00	€ 849,00	€ 849,00
CL***	CL***		€ 798,00	€ 882,00	€ 882,00	€ 882,00	€ 882,00

\*Excluding / Escluso C36+C39, H120+H127, H140+H143, PBS-PCO-PMS-PVE

\*\*Perforated mid-grain leather (inner part of the back, upper part of the seat)  
Pelle forata (parte interna dello schienale e parte superiore del sedile)

For fabrics see page 367  
Per i tessuti si veda a p. 367

\*\*\*TC/CL = Minimum order 10 pcs each fabric colour. Feasibility to be approved  
TC/CL = Ordine minimo 10 pz per colore/tessuto. Fattibilità da valutare

PACKING / Imballo

TECHNICAL DETAILS / Dettagli tecnici



FABRIC REQUIRED / Fabbisogno tessuto  
1pc: Lin Mtrs 1,90 (h 1,40)

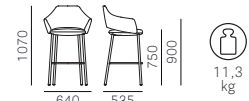

SAFETY, STRENGTH and DURABILITY TESTS  
Prove di sicurezza, resistenza e durata  
EN 1728:2012+AC2013  
EN 16139:2013 level 2

For colours and finishes see at page 362  
Per colori e finiture vedere da pagina 362

## Vic Metal 648/2

ABS shell below cover  
Guscio sottoscocca in ABS



SEAT Sedile	BACK Schienale	FRAME Telaio	POWDER COATED Verniciato	SATINIZED Satinato	BRUSHED BRONZE Bronzo satinato	ANTIQU BRASS Ottone anticato	TITANIUM Titanio
A	A	H750	€ 714,00	€ 798,00	€ 798,00	€ 798,00	€ 798,00
C*	C*		€ 751,00	€ 834,00	€ 834,00	€ 834,00	€ 834,00
D40+D44	D40+D44		€ 794,00	€ 877,00	€ 877,00	€ 877,00	€ 877,00
E	E		€ 919,00	€ 1.003,00	€ 1.003,00	€ 1.003,00	€ 1.003,00
G	G		€ 860,00	€ 943,00	€ 943,00	€ 943,00	€ 943,00
H*	H*		€ 765,00	€ 849,00	€ 849,00	€ 849,00	€ 849,00
P*	P*		€ 1.010,00	€ 1.094,00	€ 1.094,00	€ 1.094,00	€ 1.094,00
PF**	PF**		€ 1.056,00	€ 1.140,00	€ 1.140,00	€ 1.140,00	€ 1.140,00
TC***	TC***		€ 714,00	€ 798,00	€ 798,00	€ 798,00	€ 798,00
CL***	CL***		€ 747,00	€ 831,00	€ 831,00	€ 831,00	€ 831,00

\*Excluding / Escluso C36+C39, H120+H127, H140+H143, PBS-PCO-PMS-PVE

\*\*Perforated mid-grain leather (inner part of the back, upper part of the seat)  
Pelle forata (parte interna dello schienale e parte superiore del sedile)

\*\*\*TC/CL = Minimum order 10 pcs each fabric colour. Feasibility to be approved  
TC/CL = Ordine minimo 10 pz per colore/tessuto. Fattibilità da valutare

ABS SHELL BELOW COVER / Guscio sottoscocca in ABS

PACKING / Imballo

TECHNICAL DETAILS / Dettagli tecnici



NE

For fabrics see page 367  
Per i tessuti si veda a p. 367



FABRIC REQUIRED / Fabbisogno tessuto  
1pc: Lin Mtrs 1,20 (h 1,40)

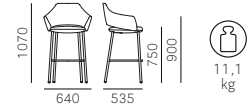

SAFETY, STRENGTH and DURABILITY TESTS  
Prove di sicurezza, resistenza e durata  
EN 1728:2012+AC2013  
EN 16139:2013 level 2

## Volt 670



SEAT Sedile	BACK Schienale	FRAME Telaio	POLYPROPYLENE Polipropilene
PPL	PPL	PPL	€ 64,00

PPL FINISHES / Finiture PPL

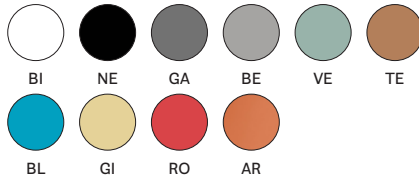

PACKING / Imballo

TECHNICAL DETAILS / Dettagli tecnici

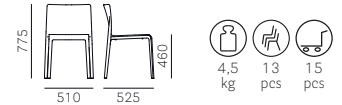

SAFETY, STRENGTH and DURABILITY TESTS  
Prove di sicurezza, resistenza e durata  
EN 1728:2012+AC2013  
EN 16139:2013 level 2  
ANSI-BIFMA X5.1-2017

## Volt 670/CL1

Fire retardant version  
Versione ignifuga



SEAT Sedile	BACK Schienale	FRAME Telaio	POLYPROPYLENE Polipropilene
PPL	PPL	PPL	€ 93,00

Minimum order 4 pcs  
Ordine minimo 4 pz

PPL FINISHES / Finiture PPL



BI

PACKING / Imballo

TECHNICAL DETAILS / Dettagli tecnici

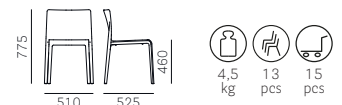

SAFETY, STRENGTH and DURABILITY TESTS  
Prove di sicurezza, resistenza e durata  
EN 1728:2012+AC2013  
EN 16139:2013 level 2  
ANSI-BIFMA X5.1-2017

For colours and finishes see at page 362  
Per colori e finiture vedere da pagina 362

# Volt 671



SEAT Sedile	BACK Schienale	FRAME Telaio	FABRIC Tessuto
C83+C89; C100+C101 C110+C122	C83+C89; C100+C101 C110+C122		€ 220,00
C90+C95	C90+C95	PPL	€ 220,00
D40+D44	D40+D44		€ 225,00

For fabrics see page 367  
Per i tessuti si veda a p. 367

PPL FINISHES / Finiture PPL

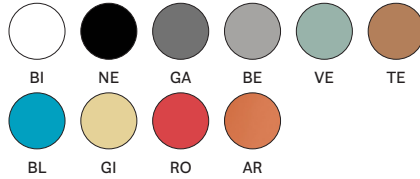

PACKING / Imballo



TECHNICAL DETAILS / Dettagli tecnici

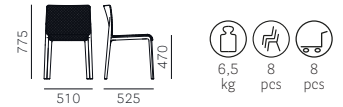

**SAFETY, STRENGTH and DURABILITY TESTS**  
Prove di sicurezza, resistenza e durata  
EN 1728:2012+AC2013  
EN 16139:2013 level 2  
ANSI-BIFMA X5.1-2017

# Volt 671/2



SEAT Sedile	BACK Schienale	FRAME Telaio	FABRIC Tessuto
A			€ 135,00
C*			€ 140,00
D40+D44	PPL	PPL	€ 147,00
G			€ 157,00
H*			€ 142,00

\*Excluding / Escluso C36+C39, H140+H143

PPL FINISHES / Finiture PPL

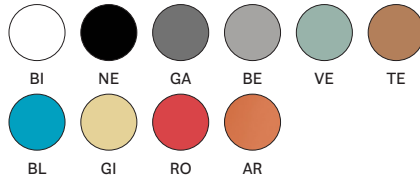

For fabrics see page 367  
Per i tessuti si veda a p. 367

PACKING / Imballo



TECHNICAL DETAILS / Dettagli tecnici

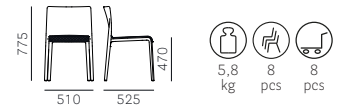

**SAFETY, STRENGTH and DURABILITY TESTS**  
Prove di sicurezza, resistenza e durata  
EN 1728:2012+AC2013  
EN 16139:2013 level 2  
ANSI-BIFMA X5.1-2017

# Volt 675



SEAT Sedile	BACK Schienale	FRAME Telaio	POLYPROPYLENE Polipropilene
PPL	PPL	PPL	€ 75,00

PPL FINISHES / Finiture PPL



PACKING / Imballo



TECHNICAL DETAILS / Dettagli tecnici

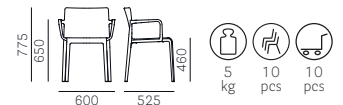

**SAFETY, STRENGTH and DURABILITY TESTS**  
Prove di sicurezza, resistenza e durata  
EN 1728:2012+AC2013  
EN 16139:2013 level 2



## Volt 675/CL1

Fire retardant version  
Versione ignifuga



SEAT Sedile	BACK Schienale	FRAME Telaio	POLYPROPYLENE Polipropilene
PPL	PPL	PPL	€ 107,00

Minimum order 300 pcs  
Ordine minimo 300 pz

PPL FINISHES / Finiture PPL



BI

PACKING / Imballo



TECHNICAL DETAILS / Dettagli tecnici

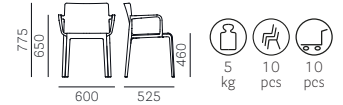

SAFETY, STRENGTH and DURABILITY TESTS  
Prove di sicurezza, resistenza e durata  
EN 1728:2012+AC2013  
EN 16139:2013 level 2

## Volt 676



SEAT Sedile	BACK Schienale	FRAME Telaio	FABRIC Tessuto
C83+C89; C100+C101 C110+C122	C83+C89; C100+C101 C110+C122		€ 231,00
C90+C95	C90+C95	PPL	€ 231,00
D40+D44	D40+D44		€ 236,00

For fabrics see page 367  
Per i tessuti si veda a p. 367

PPL FINISHES / Finiture PPL



BI

NE

GA

BE

VE

TE



BL



GI



RO



AR

PACKING / Imballo



TECHNICAL DETAILS / Dettagli tecnici

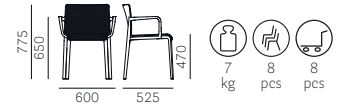

SAFETY, STRENGTH and DURABILITY TESTS  
Prove di sicurezza, resistenza e durata  
EN 1728:2012+AC2013  
EN 16139:2013 level 2

## Volt 676/2



SEAT Sedile	BACK Schienale	FRAME Telaio	FABRIC Tessuto
A			€ 146,00
C*			€ 151,00
D40+D44	PPL	PPL	€ 158,00
G			€ 168,00
H*			€ 153,00

\*Excluding / Escluso C36+C39, H140+H143

PPL FINISHES / Finiture PPL



BI

NE

GA

BE

VE

TE



BL



GI



RO



AR

PACKING / Imballo



TECHNICAL DETAILS / Dettagli tecnici

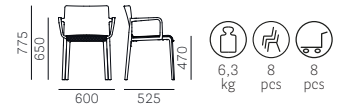

SAFETY, STRENGTH and DURABILITY TESTS  
Prove di sicurezza, resistenza e durata  
EN 1728:2012+AC2013  
EN 16139:2013 level 2



## Volt 677



SEAT Sedile	BACK Schienale	FRAME Telaio	POLYPROPYLENE Polipropilene
PPL	PPL	PPL H660	€ 85,00

### PPL FINISHES / Finiture PPL

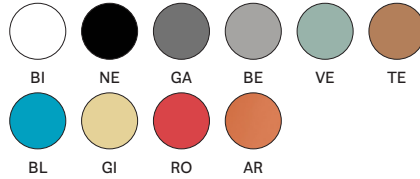

### PACKING / Imballo



### TECHNICAL DETAILS / Dettagli tecnici



**SAFETY, STRENGTH and DURABILITY TESTS**  
 Prove di sicurezza, resistenza e durata  
 EN 1728:2012+AC2013  
 EN 16139:2013 level 2



## Volt 678



SEAT Sedile	BACK Schienale	FRAME Telaio	POLYPROPYLENE Polipropilene
PPL	PPL	PPL H765	€ 85,00

### PPL FINISHES / Finiture PPL

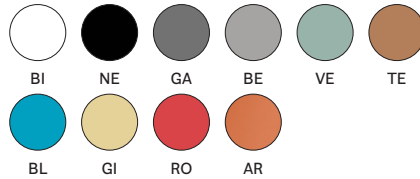

### PACKING / Imballo



### TECHNICAL DETAILS / Dettagli tecnici

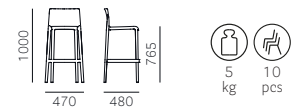

**SAFETY, STRENGTH and DURABILITY TESTS**  
 Prove di sicurezza, resistenza e durata  
 EN 1728:2012+AC2013  
 EN 16139:2013 level 2



## Volt 677/2



SEAT Sedile	BACK Schienale	FRAME Telaio	FABRIC Tessuto
A			€ 151,00
C*			€ 157,00
D40÷D44	PPL	PPL H680	€ 163,00
G			€ 173,00
H*			€ 159,00

\*Excluding / Escluso C36+C39, H140+H143

For fabrics see page 367  
 Per i tessuti si veda a p. 367

### PPL FINISHES / Finiture PPL



### PACKING / Imballo



### TECHNICAL DETAILS / Dettagli tecnici

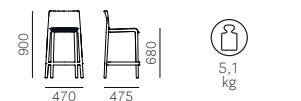

**SAFETY, STRENGTH and DURABILITY TESTS**  
 Prove di sicurezza, resistenza e durata  
 EN 1728:2012+AC2013  
 EN 16139:2013 level 2

## Volt 678/2



SEAT Sedile	BACK Schienale	FRAME Telaio	FABRIC Tessuto
A			€ 151,00
C*			€ 157,00
D40+D44	PPL	PPL H785	€ 163,00
G			€ 173,00
H*			€ 159,00

\*Excluding / Escluso C36+C39, H140+H143

### PPL FINISHES / Finiture PPL

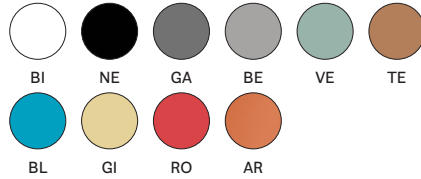

**SAFETY, STRENGTH and DURABILITY TESTS**  
 Prove di sicurezza, resistenza e durata  
 EN 1728:2012+AC2013  
 EN 16139:2013 level 2

For fabrics see page 367  
 Per i tessuti si veda a p. 367

### PACKING / Imballo



### TECHNICAL DETAILS / Dettagli tecnici

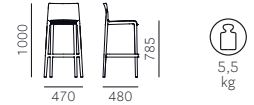

## Volt HB 673



SEAT Sedile	BACK Schienale	FRAME Telaio	POLYPROPYLENE Polipropilene
PPL	PPL	PPL	€ 66,00

### PPL FINISHES / Finiture PPL



**SAFETY, STRENGTH and DURABILITY TESTS**  
 Prove di sicurezza, resistenza e durata  
 EN 1728:2012+AC2013  
 EN 16139:2013 level 2

### PACKING / Imballo



### TECHNICAL DETAILS / Dettagli tecnici

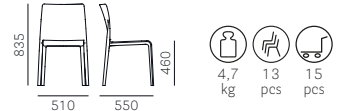

## Volt HB 673/2



SEAT Sedile	BACK Schienale	FRAME Telaio	FABRIC Tessuto
A			€ 137,00
C*			€ 142,00
D40+D44	PPL	PPL	€ 149,00
G			€ 159,00
H*			€ 145,00

\*Excluding / Escluso C36+C39, H140+H143

### PPL FINISHES / Finiture PPL



**SAFETY, STRENGTH and DURABILITY TESTS**  
 Prove di sicurezza, resistenza e durata  
 EN 1728:2012+AC2013  
 EN 16139:2013 level 2

For fabrics see page 367  
 Per i tessuti si veda a p. 367

### PACKING / Imballo



### TECHNICAL DETAILS / Dettagli tecnici

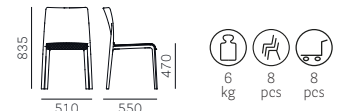

## Volt HB 674



SEAT Sedile	BACK Schienale	FRAME Telaio	POLYPROPYLENE Polipropilene
PPL	PPL	PPL	<b>€ 77,00</b>

PPL FINISHES / Finiture PPL

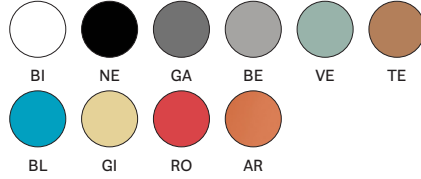

PACKING / Imballo



TECHNICAL DETAILS / Dettagli tecnici

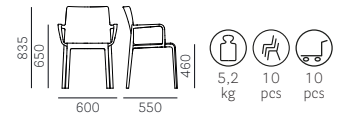

**SAFETY, STRENGTH and DURABILITY TESTS**  
 Prove di sicurezza, resistenza e durata  
 EN 1728:2012+AC2013  
 EN 16139:2013 level 2



## Volt HB 674/2



SEAT Sedile	BACK Schienale	FRAME Telaio	FABRIC Tessuto
A			<b>€ 148,00</b>
C*			<b>€ 153,00</b>
D40+D44	PPL	PPL	<b>€ 160,00</b>
G			<b>€ 170,00</b>
H*			<b>€ 156,00</b>

\*Excluding / Escluso C36+C39, H140+H143

PPL FINISHES / Finiture PPL

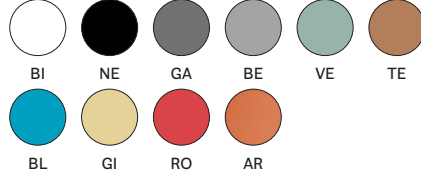

For fabrics see page 367  
 Per i tessuti si veda a p. 367

PACKING / Imballo



TECHNICAL DETAILS / Dettagli tecnici

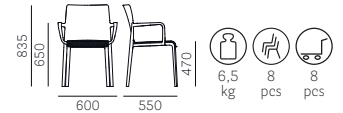

**SAFETY, STRENGTH and DURABILITY TESTS**  
 Prove di sicurezza, resistenza e durata  
 EN 1728:2012+AC2013  
 EN 16139:2013 level 2

## Woody 495

Gas lift device  
 Alzata a gas



SEAT Sedile	FRAME Telaio	CHROMED Cromato	SATINIZED Satinato
RS-W	Ø 400 H640+780	<b>€ 335,00</b>	<b>€ 354,00</b>

FINISHES / Finiture



PACKING / Imballo



TECHNICAL DETAILS / Dettagli tecnici

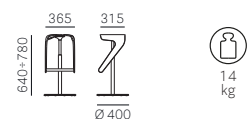

**SAFETY, STRENGTH and DURABILITY TESTS**  
 Prove di sicurezza, resistenza e durata  
 EN 15373:2007



## Woody 496



SEAT Sedile	FRAME Telaio	CHROMED Cromato	BRUSHED S/STEEL Inox satinato
RS-W	Ø 400 H770	€ 335,00	€ 335,00

### FINISHES / Finiture



### PACKING / Imballo

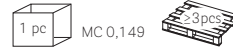

### TECHNICAL DETAILS / Dettagli tecnici

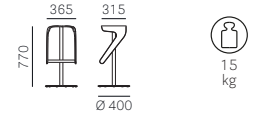

**SAFETY, STRENGTH and DURABILITY TESTS**  
 Prove di sicurezza, resistenza e durata  
 EN 15373:2007



## Wow 320



SEAT Sedile	FRAME Telaio	FABRIC Tessuto
A		€ 150,00
C		€ 177,00
D120+D123	360x360	€ 209,00
G	H480	€ 263,00
H		€ 183,00
TC *		€ 150,00

\*TC = Minimum order 10 pcs each fabric colour  
 TC = Ordine minimo 10 pz per colore/tessuto

For fabrics see page 367  
 Per i tessuti si veda a p. 367

### PACKING / Imballo



### TECHNICAL DETAILS / Dettagli tecnici

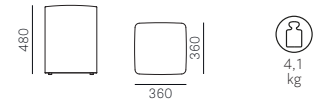

**FABRIC REQUIRED / Fabbisogno tessuto**  
 1pc: Lin Mtrs 0,95 (h 1,40)

## Wow 321



SEAT Sedile	FRAME Telaio	FABRIC Tessuto
A		€ 269,00
C		€ 312,00
D120+D123	910x360	€ 389,00
G	H480	€ 445,00
H		€ 323,00
TC *		€ 269,00

\*TC = Minimum order 10 pcs each fabric colour  
 TC = Ordine minimo 10 pz per colore/tessuto

For fabrics see page 367  
 Per i tessuti si veda a p. 367

### PACKING / Imballo



### TECHNICAL DETAILS / Dettagli tecnici

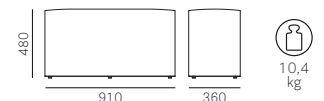

**FABRIC REQUIRED / Fabbisogno tessuto**  
 1pc: Lin Mtrs 1,46 (h 1,40)

## Wow 322



SEAT Sedile	FRAME Telaio	FABRIC Tessuto
A	D120÷D123 Ø 400 H480	€ 147,00
C		€ 172,00
G		€ 254,00
H		€ 179,00
TC *		€ 147,00

\*TC = Minimum order 10 pcs each fabric colour  
TC = Ordine minimo 10 pz per colore/tessuto

For fabrics see page 367  
Per i tessuti si veda a p. 367

## PACKING / Imballo



FABRIC REQUIRED / Fabbisogno tessuto  
1pc: Lin Mtrs 1,20 (h 1,40)

## TECHNICAL DETAILS / Dettagli tecnici

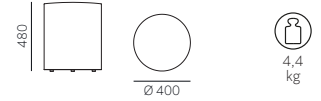

## Wow 327



SEAT Sedile	FRAME Telaio	CHROMED Cromato	BRUSHED BRONZE Bronzo satinato	ANTIQUÉ BRASS Ottone anticato
A	D120÷D123 Ø 400 H480	€ 214,00	€ 242,00	€ 242,00
C		€ 240,00	€ 267,00	€ 267,00
G		€ 267,00	€ 294,00	€ 294,00
H		€ 322,00	€ 349,00	€ 349,00
TC *		€ 247,00	€ 274,00	€ 274,00
		€ 214,00	€ 242,00	€ 242,00

\*TC = Minimum order 10 pcs each fabric colour  
TC = Ordine minimo 10 pz per colore/tessuto

For fabrics see page 367  
Per i tessuti si veda a p. 367

## PACKING / Imballo



FABRIC REQUIRED / Fabbisogno tessuto  
1pc: Lin Mtrs 1,20 (h 1,40)

## TECHNICAL DETAILS / Dettagli tecnici

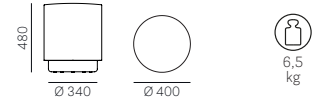

## Wow 323



SEAT Sedile	FRAME Telaio	FABRIC Tessuto
A	D120÷D123 Ø 650 H430	€ 250,00
C		€ 296,00
G		€ 361,00
H		€ 433,00
TC *		€ 307,00
		€ 250,00

\*TC = Minimum order 10 pcs each fabric colour  
TC = Ordine minimo 10 pz per colore/tessuto

For fabrics see page 367  
Per i tessuti si veda a p. 367

## PACKING / Imballo



FABRIC REQUIRED / Fabbisogno tessuto  
1pc: Lin Mtrs 2,12 (h 1,40)

## TECHNICAL DETAILS / Dettagli tecnici

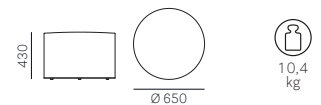

## Wow 326



SEAT Sedile	FRAME Telaio	CHROMED Cromato	BRUSHED BRONZE Bronzo satinato	ANTIQUE BRASS Ottone anticato
A		€ 357,00	€ 404,00	€ 404,00
C		€ 403,00	€ 450,00	€ 450,00
D120+D123	Ø 650 H430	€ 469,00	€ 516,00	€ 516,00
G		€ 540,00	€ 587,00	€ 587,00
H		€ 414,00	€ 461,00	€ 461,00
TC *		€ 357,00	€ 404,00	€ 404,00

\*TC = Minimum order 10 pcs each fabric colour  
TC = Ordine minimo 10 pz per colore/tessuto

For fabrics see page 367  
Per i tessuti si veda a p. 367

## PACKING / Imballo



**FABRIC REQUIRED** / Fabbisogno tessuto  
1pc: Lin Mtrs 2,12 (h 1,40)

## TECHNICAL DETAILS / Dettagli tecnici

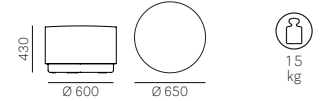

## Wow 324



SEAT Sedile	FRAME Telaio	FABRIC Tessuto
A		€ 258,00
C		€ 299,00
D120+D123	600x600 H430	€ 361,00
G		€ 437,00
H		€ 309,00
TC *		€ 258,00

\*TC = Minimum order 10 pcs each fabric colour  
TC = Ordine minimo 10 pz per colore/tessuto

For fabrics see page 367  
Per i tessuti si veda a p. 367

## PACKING / Imballo



**FABRIC REQUIRED** / Fabbisogno tessuto  
1pc: Lin Mtrs 2,00 (h 1,40)

## TECHNICAL DETAILS / Dettagli tecnici

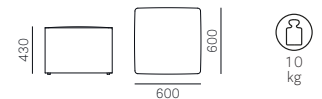

## Wow 325



SEAT Sedile	FRAME Telaio	FABRIC Tessuto
A		€ 378,00
C		€ 434,00
D120+D123	Ø 850 H430	€ 534,00
G		€ 617,00
H		€ 449,00
TC *		€ 378,00

\*TC = Minimum order 10 pcs each fabric colour  
TC = Ordine minimo 10 pz per colore/tessuto

For fabrics see page 367  
Per i tessuti si veda a p. 367

## PACKING / Imballo



**FABRIC REQUIRED** / Fabbisogno tessuto  
1pc: Lin Mtrs 2,30 (h 1,40)

## TECHNICAL DETAILS / Dettagli tecnici



## Wow 470



SEAT Sedile	FRAME Telaio	POLYETHYLENE Polietilene
PET	Ø 660	€ 144,00

### PET FINISHES / Finiture PET



### PACKING / Imballo



### TECHNICAL DETAILS / Dettagli tecnici

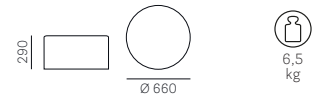

## Wow 472



SEAT Sedile	FRAME Telaio	METHACRYLATE Metacrilato
	Ø 630	€ 133,00

Two-coloured top for WOW item 470  
Ripiano bicolore per WOW art.470

### ME FINISHES / Finiture ME



### PACKING / Imballo



### TECHNICAL DETAILS / Dettagli tecnici



## Wow 470+473



SEAT Sedile	FRAME Telaio	POLYETHYLENE Polietilene
PET	Ø 600	€ 210,00

WOW item 470 + chromed base item 473  
WOW art.470 + base cromata art. 473

### PET FINISHES / Finiture PET



### PACKING / Imballo



### TECHNICAL DETAILS / Dettagli tecnici

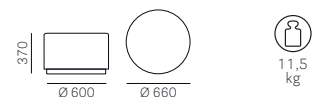

## Wow 475

LUMINOUS  
LUMINOSO



SEAT Sedile	FRAME Telaio	POLYETHYLENE Polietilene
PET	Ø 630	

English plug version: surcharge € 35,00 (item 475\_UK)  
Versione con presa britannica: supplemento € 35,00 (art. 475\_UK)

PET FINISHES / Finiture PET



BI

PACKING / Imballo



TECHNICAL DETAILS / Dettagli tecnici

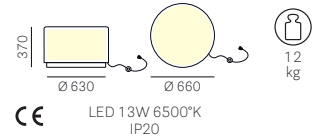

## Wow 475E

LUMINOUS  
LUMINOSO



SEAT Sedile	FRAME Telaio	POLYETHYLENE Polietilene
PET	Ø 630	

PET FINISHES / Finiture PET



BI

PACKING / Imballo



TECHNICAL DETAILS / Dettagli tecnici

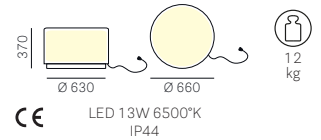

## Wow 475L

LED



SEAT Sedile	FRAME Telaio	POLYETHYLENE Polietilene
PET	Ø 630	

PET FINISHES / Finiture PET



BI



LED RGB

With LED that change colours: red, yellow, green, violet, blue, light blue  
Con LED che cambiano colore: rosso, giallo, verde, viola, blu, azzurro

PACKING / Imballo



TECHNICAL DETAILS / Dettagli tecnici

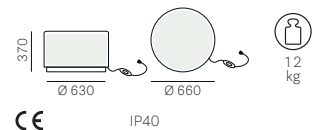



## Wow 480



SEAT Sedile	FRAME Telaio	POLYETHYLENE Polietilene
PET	Ø 400	<b>€ 91,00</b>

### PET FINISHES / Finiture PET



### PACKING / Imballo



### TECHNICAL DETAILS / Dettagli tecnici



## Wow 482



SEAT Sedile	FRAME Telaio	METHACRYLATE Metacrilato
	Ø 375	<b>€ 52,00</b>

Two-coloured top for WOW item 480  
Ripiano bicolore per WOW art.480

### ME FINISHES / Finiture ME



### PACKING / Imballo



### TECHNICAL DETAILS / Dettagli tecnici



## Wow 480+483



SEAT Sedile	FRAME Telaio	POLYETHYLENE Polietilene
PET	Ø 340	<b>€ 126,00</b>

WOW item 480 + chromed base item 483  
WOW art.480 + base cromata art.483

### PET FINISHES / Finiture PET



### PACKING / Imballo



### TECHNICAL DETAILS / Dettagli tecnici

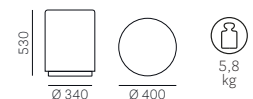

## Wow 485

LUMINOUS  
LUMINOSO



SEAT Sedile	FRAME Telaio	POLYETHYLENE Polietilene
PET	Ø 400	€ 177,00

English plug version: surcharge € 35,00 (item 485\_UK)  
Versione con presa britannica: supplemento € 35,00 (art. 485\_UK)

PET FINISHES / Finiture PET



PACKING / Imballo



TECHNICAL DETAILS / Dettagli tecnici

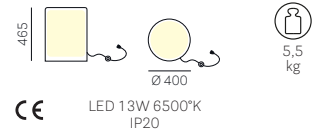

## Wow 485E

LUMINOUS  
LUMINOSO



SEAT Sedile	FRAME Telaio	POLYETHYLENE Polietilene
PET	Ø 400	€ 178,00

PET FINISHES / Finiture PET



PACKING / Imballo



TECHNICAL DETAILS / Dettagli tecnici

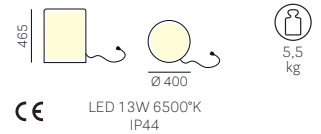

## Wow 485L

LED



SEAT Sedile	FRAME Telaio	POLYETHYLENE Polietilene
PET	Ø 400	€ 285,00

PET FINISHES / Finiture PET



LED RGB

With LED that change colours: red, yellow, green, violet, blue, light blue  
Con LED che cambiano colore: rosso, giallo, verde, viola, blu, azzurro

PACKING / Imballo



TECHNICAL DETAILS / Dettagli tecnici

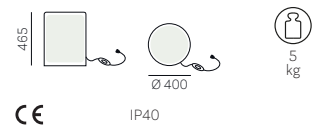

# Wow 486

LUMINOUS  
LUMINOSO



SEAT Sedile	FRAME Telaio	POLYETHYLENE Polietilene
	Ø 310	

**€ 350,00**  
Methacrylate top included  
Con ripiano in metacrilato

PET FINISHES / Finiture PET



BI

ME FINISHES / Finiture ME



OP

PACKING / Imballo



MC 0,087

TECHNICAL DETAILS / Dettagli tecnici

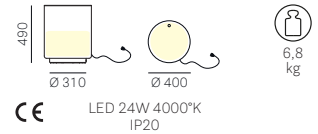

LED 24W 4000°K  
IP20

# Young 420



SEAT Sedile	BACK Schienale	FRAME Telaio	OAK Rovere	OAK STAINED ON SAMPLE Rovere tinto campione
RS-W-N1- GC-BI	RS-W-N1- GC-BI	RS-W-N1- GC-BI	<b>€ 266,00</b>	
TC	TC	TC		<b>€ 289,00</b>

Minimum order q.ty: 20 pcs  
Ordine minimo: 20pz

FINISHES / Finiture



RS W N1 GC BI

PACKING / Imballo



MC 0,305

TECHNICAL DETAILS / Dettagli tecnici

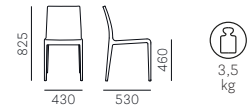

SAFETY, STRENGTH and DURABILITY TESTS  
Prove di sicurezza, resistenza e durata  
EN 1728:2000  
ANSI BIFMA X5.1-2002

# Young 420



SEAT Sedile	BACK Schienale	FRAME Telaio	OAK Rovere
BL2 AZ1 VE2 VE1 RB RA MO MC	BL2 AZ1 VE2 VE1 RB RA MO MC	BL2 AZ1 VE2 VE1 RB RA MO MC	<b>€ 278,00</b> Lacquered with visible grains Laccato a poro aperto

FINISHES / Finiture



BL2 AZ1 VE2 VE1  
RB RA MO MC

PACKING / Imballo



MC 0,305

TECHNICAL DETAILS / Dettagli tecnici

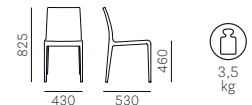

SAFETY, STRENGTH and DURABILITY TESTS  
Prove di sicurezza, resistenza e durata  
EN 1728:2000  
ANSI BIFMA X5.1-2002



PRODUCT CERTIFIED  
FOR LOW CHEMICAL  
EMISSIONS:  
UL.COM/GG  
UL 2818



PRODUCT CERTIFIED  
FOR LOW CHEMICAL  
EMISSIONS:  
UL.COM/GG  
UL 2818

## Young 420



SEAT Sedile	BACK Schienale	FRAME Telaio	OAK Rovere
V101- V102-V103	V101- V102-V103	V101- V102-V103	<b>€ 301,00</b> Vintage / Anticato

### FINISHES / Finiture



V101 V102 V103

### PACKING / Imballo



### TECHNICAL DETAILS / Dettagli tecnici

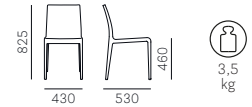

**SAFETY, STRENGTH and DURABILITY TESTS**  
Prove di sicurezza, resistenza e durata  
EN 1728:2000  
ANSI BIFMA X5.1-2002



PRODUCT CERTIFIED  
FOR LOW CHEMICAL  
EMISSIONS:  
UL COMGG  
UL 2818

## Young 421



SEAT Sedile	BACK Schienale	FRAME Telaio	OAK Rovere	OAK STAINED ON SAMPLE Rovere tinto campione
RS-W-N1- GC-BI	RS-W-N1- GC-BI	RS-W-N1- GC-BI	<b>€ 362,00</b>	
TC	TC	TC		<b>€ 386,00</b>

### FINISHES / Finiture



RS W N1 GC BI

### PACKING / Imballo



### TECHNICAL DETAILS / Dettagli tecnici

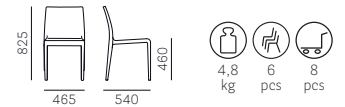

**SAFETY, STRENGTH and DURABILITY TESTS**  
Prove di sicurezza, resistenza e durata  
EN 1728:2000

Minimum order q.ty: 20 pcs  
Ordine minimo: 20pz



PRODUCT CERTIFIED  
FOR LOW CHEMICAL  
EMISSIONS:  
UL COMGG  
UL 2818

## Young 421



SEAT Sedile	BACK Schienale	FRAME Telaio	OAK Rovere
BL2 AZ1 VE2 VE1 RB RA MO MC	BL2 AZ1 VE2 VE1 RB RA MO MC	BL2 AZ1 VE2 VE1 RB RA MO MC	<b>€ 375,00</b> Lacquered with visible grains Laccato a poro aperto

### FINISHES / Finiture



BL2 AZ1 VE2 VE1  
RB RA MO MC

### PACKING / Imballo



### TECHNICAL DETAILS / Dettagli tecnici

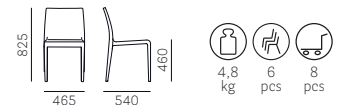

**SAFETY, STRENGTH and DURABILITY TESTS**  
Prove di sicurezza, resistenza e durata  
EN 1728:2000



PRODUCT CERTIFIED  
FOR LOW CHEMICAL  
EMISSIONS:  
UL COMGG  
UL 2818

## Young 421



SEAT Sedile	BACK Schienale	FRAME Telaio	OAK Rovere
V101- V102-V103	V101- V102-V103	V101- V102-V103	<b>€ 398,00</b> Vintage / Anticato

### FINISHES / Finiture



V101 V102 V103

### PACKING / Imballo



### TECHNICAL DETAILS / Dettagli tecnici

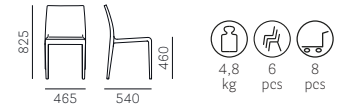

**SAFETY, STRENGTH and DURABILITY TESTS**  
Prove di sicurezza, resistenza e durata  
EN 1728:2000



## Young 423



SEAT Sedile	BACK Schienale	FRAME Telaio	OAK Rovere	OAK STAINED ON SAMPLE Rovere tinto campione
A	A		<b>€ 359,00</b>	<b>€ 382,00</b>
C*	C*		<b>€ 377,00</b>	<b>€ 401,00</b>
G	G	RS-W-N1- GC-BI	<b>€ 428,00</b>	<b>€ 451,00</b>
H*	H*		<b>€ 382,00</b>	<b>€ 405,00</b>
P*	P*	TC	<b>€ 455,00</b>	<b>€ 478,00</b>
TC**	TC**		<b>€ 359,00</b>	<b>€ 382,00</b>
CL**	CL**		<b>€ 364,00</b>	<b>€ 387,00</b>

\*\*TC/CL = Minimum order 10 pcs each fabric colour  
TC/CL = Ordine minimo 10 pz per colore/tessuto

\*Excluding / Escluso C36+C39, H140+H143, PBS-PCO-PMS-PVE

### FINISHES / Finiture



RS W N1 GC BI

For fabrics see page 367  
Per i tessuti si veda a p. 367

### PACKING / Imballo



**FABRIC REQUIRED / Fabbisogno tessuto**  
1pc: Lin Mtrs 0,80 (h 1,40)

### TECHNICAL DETAILS / Dettagli tecnici

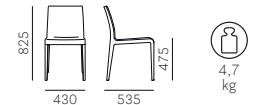

## Young 424



SEAT Sedile	BACK Schienale	FRAME Telaio	OAK Rovere	OAK STAINED ON SAMPLE Rovere tinto campione
A	A		<b>€ 455,00</b>	<b>€ 478,00</b>
C*	C*		<b>€ 473,00</b>	<b>€ 496,00</b>
G	G	RS-W-N1- GC-BI	<b>€ 524,00</b>	<b>€ 547,00</b>
H*	H*		<b>€ 478,00</b>	<b>€ 501,00</b>
P*	P*	TC	<b>€ 551,00</b>	<b>€ 574,00</b>
TC**	TC**		<b>€ 455,00</b>	<b>€ 478,00</b>
CL**	CL**		<b>€ 459,00</b>	<b>€ 482,00</b>

\*\*TC/CL = Minimum order 10 pcs each fabric colour  
TC/CL = Ordine minimo 10 pz per colore/tessuto

\*Excluding / Escluso C36+C39, H140+H143, PBS-PCO-PMS-PVE

### FINISHES / Finiture



RS W N1 GC BI

For fabrics see page 367  
Per i tessuti si veda a p. 367

### PACKING / Imballo



**FABRIC REQUIRED / Fabbisogno tessuto**  
1pc: Lin Mtrs 0,80 (h 1,40)

### TECHNICAL DETAILS / Dettagli tecnici

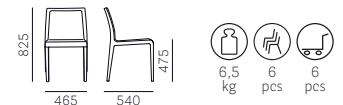

## Young 426



SEAT Sedile	BACK Schienale	FRAME Telaio	OAK Rovere	OAK STAINED ON SAMPLE Rovere tinto campione
RS-W-N1- GC-BI	RS-W-N1- GC-BI	H750	<b>€ 364,00</b>	
TC	TC			<b>€ 387,00</b>

### FINISHES / Finiture



### PACKING / Imballo



### TECHNICAL DETAILS / Dettagli tecnici

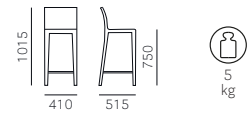

## Young 426



SEAT Sedile	BACK Schienale	FRAME Telaio	OAK Rovere
BL2 AZ1 VE2 VE1 RB RA MO MC	BL2 AZ1 VE2 VE1 RB RA MO MC	H750	<b>€ 376,00</b> Lacquered with visible grains Laccato a poro aperto

### FINISHES / Finiture



### PACKING / Imballo



### TECHNICAL DETAILS / Dettagli tecnici

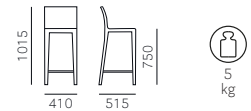

## Young 426



SEAT Sedile	BACK Schienale	FRAME Telaio	OAK Rovere
V101- V102-V103	V101- V102-V103	H750	<b>€ 399,00</b> Vintage / Anticato

### FINISHES / Finiture



### PACKING / Imballo



### TECHNICAL DETAILS / Dettagli tecnici

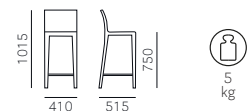

## Young 428



SEAT Sedile	BACK Schienale	FRAME Telaio	OAK Rovere	OAK STAINED ON SAMPLE Rovere tinto campione
A	A		€ 465,00	€ 488,00
C*	C*		€ 476,00	€ 499,00
G	G		€ 520,00	€ 543,00
H*	H*	H770	€ 488,00	€ 511,00
P*	P*		€ 552,00	€ 575,00
TC**	TC**		€ 465,00	€ 488,00
CL**	CL**		€ 470,00	€ 493,00

\*\*TC/CL = Minimum order 10 pcs each fabric colour  
TC/CL = Ordine minimo 10 pz per colore/tessuto

\*Excluding / Escluso C36+C39, H140+H143, PBS-PCO-PMS-PVE

For fabrics see page 367  
Per i tessuti si veda a p. 367

Minimum order q.ty: 20 pcs  
Ordine minimo: 20pz

### FINISHES / Finiture



For fabrics see page 367  
Per i tessuti si veda a p. 367

### PACKING / Imballo



FABRIC REQUIRED / Fabbisogno tessuto  
On request / A richiesta

### TECHNICAL DETAILS / Dettagli tecnici



## Zippo ZIP2P/100

Low back  
Schienale basso



SEAT Sedile	BACK Schienale	FRAME Telaio	WHITE/BLACK/ALUMINIUM POWDER COATED Verniciato bianco/nero/alluminio
A	A		€ 1.606,00
C*	C*		€ 1.791,00
D40+D44	D40+D44	Ø 16	€ 2.016,00
G	G		€ 2.345,00
H*	H*		€ 1.825,00

Sound absorption measurement: 100 Hz = 1,46 (EN ISO 354:2003)  
Coefficiente assorbimento acustico: 100 Hz = 1,46 (EN ISO 354:2003)

\*Excluding / Escluso C36+C39, H140+H143

### FINISHES / Finiture



### PACKING / Imballo



### TECHNICAL DETAILS / Dettagli tecnici

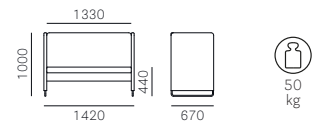

## Zippo ZIP2P/140

High back  
Schienale alto



SEAT Sedile	BACK Schienale	FRAME Telaio	WHITE/BLACK/ALUMINIUM POWDER COATED Verniciato bianco/nero/alluminio
A	A		€ 1.802,00
C*	C*		€ 1.987,00
D40+D44	D40+D44	Ø 16	€ 2.244,00
G	G		€ 2.588,00
H*	H*		€ 2.022,00

Sound absorption measurement: 100 Hz = 1,46 (EN ISO 354:2003)  
Coefficiente assorbimento acustico: 100 Hz = 1,46 (EN ISO 354:2003)

\*Excluding / Escluso C36+C39, H140+H143

### FINISHES / Finiture



### PACKING / Imballo

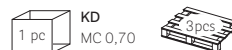

### TECHNICAL DETAILS / Dettagli tecnici

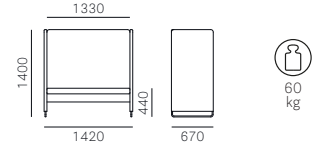

## Zippo ZIP1P/100

Low back  
Schienale basso



SEAT Sedile	BACK Schienale	FRAME Telaio	WHITE/BLACK/ALUMINIUM POWDER COATED Verniciato bianco/nero/alluminio
A	A		€ 1.415,00
C*	C*		€ 1.564,00
D40÷D44	D40÷D44	Ø 16	€ 1.736,00
G	G		€ 2.007,00
H*	H*		€ 1.591,00

Sound absorption measurement: 100 Hz = 1,46 (EN ISO 354:2003)  
Coefficiente assorbimento acustico: 100 Hz = 1,46 (EN ISO 354:2003)

\*Excluding / Escluso C36+C39, H140+H143

### FINISHES / Finiture

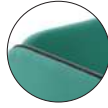

Zip colour matched with frame finish  
Colore della zip in tinta col telaio  
For fabrics see page 367  
Per i tessuti si veda a p. 367

### PACKING / Imballo



### TECHNICAL DETAILS / Dettagli tecnici

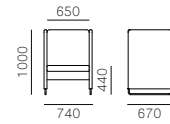

## Zippo ZIP1P/140

High back  
Schienale alto



SEAT Sedile	BACK Schienale	FRAME Telaio	WHITE/BLACK/ALUMINIUM POWDER COATED Verniciato bianco/nero/alluminio
A	A		€ 1.574,00
C*	C*		€ 1.753,00
D40÷D44	D40÷D44	Ø 16	€ 1.954,00
G	G		€ 2.283,00
H*	H*		€ 1.784,00

Sound absorption measurement: 100 Hz = 1,46 (EN ISO 354:2003)  
Coefficiente assorbimento acustico: 100 Hz = 1,46 (EN ISO 354:2003)

\*Excluding / Escluso C36+C39, H140+H143

### FINISHES / Finiture

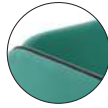

Zip colour matched with frame finish  
Colore della zip in tinta col telaio  
For fabrics see page 367  
Per i tessuti si veda a p. 367

### PACKING / Imballo



### TECHNICAL DETAILS / Dettagli tecnici

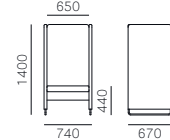

## Zippo ZIPL1P

LOUNGE



SEAT Sedile	BACK Schienale	FRAME Telaio	WHITE/BLACK/ALUMINIUM POWDER COATED Verniciato bianco/nero/alluminio
A	A		€ 1.337,00
C*	C*		€ 1.436,00
D40÷D44	D40÷D44	Ø 16	€ 1.553,00
G	G		€ 1.731,00
H*	H*		€ 1.477,00

Sound absorption measurement: 100 Hz = 1,46 (EN ISO 354:2003)  
Coefficiente assorbimento acustico: 100 Hz = 1,46 (EN ISO 354:2003)

\*Excluding / Escluso C36+C39, H140+H143

### FINISHES / Finiture

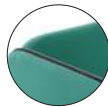

Zip colour matched with frame finish  
Colore della zip in tinta col telaio  
For fabrics see page 367  
Per i tessuti si veda a p. 367

### PACKING / Imballo



### TECHNICAL DETAILS / Dettagli tecnici

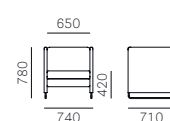



### 3001

Cushion  
Cuscino



**FABRIC**  
Tessuto

D22+D26  
D80+D89  
D100+D105  
D110+D115  
D130+D133

For fabrics see page 367  
Per i tessuti si veda a p. 367

**PRICE**  
Prezzo

**€ 100,00**

**PACKING** / Imballo



**TECHNICAL DETAILS** / Dettagli tecnici

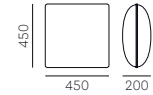

### 3002

Cushion  
Cuscino



**FABRIC**  
Tessuto

D22+D26  
D80+D89  
D100+D105  
D110+D115  
D130+D133

For fabrics see page 367  
Per i tessuti si veda a p. 367

**PRICE**  
Prezzo

**€ 100,00**

**PACKING** / Imballo



**TECHNICAL DETAILS** / Dettagli tecnici



### 3004

Cushion  
Cuscino



**FABRIC**  
Tessuto

D22+D26  
D80+D89  
D100+D105  
D110+D115  
D130+D133

For fabrics see page 367  
Per i tessuti si veda a p. 367

**PRICE**  
Prezzo

**€ 75,00**

**PACKING** / Imballo



**TECHNICAL DETAILS** / Dettagli tecnici



### 3005

Cushion  
Cuscino



FABRIC Tessuto	PRICE Prezzo
D22+D26 D80+D89 D100+D105 D110+D115 D130+D133	<b>€ 75,00</b>

For fabrics see page 367  
Per i tessuti si veda a p. 367

PACKING / Imballo



TECHNICAL DETAILS / Dettagli tecnici



1,1  
kg

### 3012

Cushion  
Cuscino



FABRIC Tessuto	PRICE Prezzo
C110+C122 C210+C217	<b>€ 105,00</b>
D120+D123	<b>€ 120,00</b>
E	<b>€ 140,00</b>
G *	<b>€ 140,00</b>
H120+H127 H140+H143	<b>€ 110,00</b>
N01+N08 N30+N38	<b>€ 150,00</b>
TC **	<b>€ 90,00</b>

\*\*TC = Minimum order 10 pcs each fabric colour  
TC = Ordine minimo 10 pz per colore/tessuto

\* Excluding / Escluso G07, G100+G102, G150+G156, G180+G185, G200+G206

For fabrics see page 367  
Per i tessuti si veda a p. 367

PACKING / Imballo



TECHNICAL DETAILS / Dettagli tecnici



0,6  
kg

FABRIC REQUIRED / Fabbisogno tessuto  
1pc: Lin Mtrs 0,50 (h 1,40)

### 3013

Cushion  
Cuscino



FABRIC Tessuto	PRICE Prezzo
C110+C122 C210+C217	<b>€ 85,00</b>
D120+D123	<b>€ 100,00</b>
E	<b>€ 125,00</b>
G *	<b>€ 125,00</b>
H120+H127 H140+H143	<b>€ 90,00</b>
N01+N08 N30+N38	<b>€ 135,00</b>
TC **	<b>€ 70,00</b>

\*\*TC = Minimum order 10 pcs each fabric colour  
TC = Ordine minimo 10 pz per colore/tessuto

\* Excluding / Escluso G07, G100+G102, G150+G156, G180+G185, G200+G206

For fabrics see page 367  
Per i tessuti si veda a p. 367

PACKING / Imballo



TECHNICAL DETAILS / Dettagli tecnici

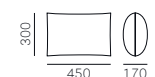



0,6  
kg

FABRIC REQUIRED / Fabbisogno tessuto  
1pc: Lin Mtrs 0,60 (h 1,40)

**Protective covers**  
Coperture protettive



CODE Codice	RECOMMENDED FOR THE FOLLOWING ITEMS: Raccomandate per i seguenti articoli:	PACKAGING Imballo	PVC PVC
COVER001	<p><b>Arki-Sofa:</b> AS0010, AS0111, AS0012, AS0040</p> <p><b>Reva, Reva Twist:</b> REVA_P, REVA/2_P</p> <p><b>Reva Cocoon:</b> RVC010, RVC012</p>	 MC 0,056	€ 150,00
COVER002	<p><b>Reva Cocoon:</b> RVC011, RVC013, RVC014</p>	 MC 0,056	€ 160,00
COVER003	<p><b>Nolita Sofa:</b> Any model / Tutti i modelli</p> <p><b>Arki-Sofa:</b> AS0030, AS0031</p>	 MC 0,056	€ 160,00
COVER004	<p><b>Reva Cocoon:</b> RVC033, RVC034</p>	 MC 0,056	€ 180,00
COVER005	<p><b>Arki-Sofa:</b> AS0020, AS0121, AS0022</p> <p><b>Reva, Reva Twist:</b> REVA_D, REVA/2_D</p> <p><b>Reva Cocoon:</b> RVC022</p>	 MC 0,056	€ 160,00
COVER006	<p><b>Reva Cocoon:</b> RVC021, RVC023, RVC024, RVC025, RVC026, RVC027</p>	 MC 0,056	€ 200,00
COVER007	<p><b>Panarea Lounge:</b> 3679 (suitable for one seat or maximum 2 stacked adatta per una seduta o massimo 2 impilate)</p>	 MC 0,056	€ 120,00

## 1391.100

Trolley  
Carrello



### SILVER POWDER COATED Verniciato alluminio

€ 123,00

For chairs / Per sedie:  
DAY DREAM, MYA, INTRIGO, INGA (Ø16),  
BABILA (Ø16), GRACE (Ø11, Ø16), KUADRA (Ø10, Ø16, 20x20),  
YOUNG, SNOW, DOME, NOA (725), KUADRA XL, ARA,  
BLITZ, JOI, TATAMI (305), VOLT, JAZZ (3719)

For stools / Per sgabelli:  
TRIBECA (3667, 3668)

For armchairs / Per poltrone:  
KUADRA, ARA, VOLT, MYA

#### PACKING / Imballo



#### TECHNICAL DETAILS / Dettagli tecnici

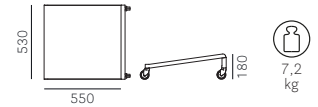

## 650.100

Trolley  
Carrello



### BLACK POWDER COATED Verniciato nero

€ 123,00

For chairs / Per sedie:  
QUEEN, BLUME (2950)

For armchairs / Per poltrone:  
BLUME (2955)

#### PACKING / Imballo



#### TECHNICAL DETAILS / Dettagli tecnici

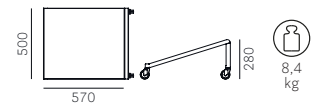

## 775.100

Trolley  
Carrello



### SILVER POWDER COATED Verniciato alluminio

€ 123,00

For chairs / Per sedie:  
TWEET, BABILA (Ø 10), NOLITA (3650, 3651), OSAKA metal (5714),  
KUADRA XL (Ø 10), INGA (Ø 10), TRIBECA (3660), REMIND (3730)

For armchairs / Per poltrone:  
KUADRA XL, TWEET, NOLITA (3655, 3656),  
OSAKA metal (5715), REMIND (3735), TRIBECA (3665)

For stools / Per sgabelli:  
TWEET, NOLITA (3657, 3658)

#### PACKING / Imballo



#### TECHNICAL DETAILS / Dettagli tecnici

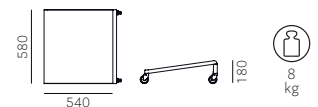

## 465-466

Trolley  
Carrello



**BLACK POWDER COATED**  
Verniciato nero

**€ 472,00**

465

With castors / Con ruote

**€ 255,00**

466

Without castors / Senza ruote

**PACKING / Imballo**



**TECHNICAL DETAILS / Dettagli tecnici**

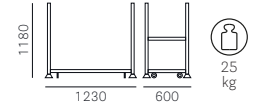

Superimposal 2 pcs / Sovrapponibile 2 pz

Trolley for Enjoy - 40 pcs  
Carrello porta Enjoy - 40 pz

## CG

Linking device  
Gancio di collegamento



**FRAME**  
Telaio

Ø 6

**CHROMED**  
Cromato

**€ 28,00**

For chairs / Per sedie:  
KUADRA (20x20, Ø16), TREND (Ø16)

For armchairs / Per poltrone:  
KUADRA (Ø16)

**€ 44,00**

For chairs / Per sedie:  
KUADRA, TREND (Ø10)

**€ 28,00**

For chair / Per sedia:  
MYA

**TECHNICAL DETAILS / Dettagli tecnici**

KUADRA - TREND

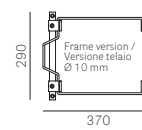
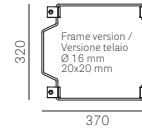

PATENTED / BREVETTATO

MYA

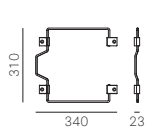

PATENTED / BREVETTATO

## KITV.LINK.D10\_L40

Linking device  
Gancio di collegamento



**FRAME**  
Telaio

NY

**NYLON**  
Nylon

**€ 7,00**

For chairs / Per sedie:  
TWEET (Ø11), DAY DREAM (Ø11), KUADRA (Ø10),  
KUADRA XL (Ø10), TREND (Ø10), INGA (Ø10),  
BABILA (Ø10), OSAKA METAL (5714)

For armchairs / Per poltrone:  
TWEET (898, 898/2)

**TECHNICAL DETAILS / Dettagli tecnici**

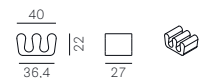

## 790/G\_NE

Linking device  
Gancio di collegamento



FRAME  
Telaio

NY

NYLON  
Nylon

**€ 55,00**  
(10 pcs/pz)

For chairs / Per sedie:  
KUADRA (Ø16), KUADRA XL (Ø16),  
TREND (Ø16), INGA (Ø16), BABILA (Ø16)  
Modular sitting systems:  
HOST 790, 791, 792, 793

PACKING / Imballo



TECHNICAL DETAILS / Dettagli tecnici

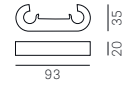

## 200/G\_NE

Linking device  
Gancio di collegamento



FRAME  
Telaio

NY

NYLON  
Nylon

**€ 55,00**  
(10 pcs/pz)

Modular sitting systems:  
HOST 200, 201, 202, 203

PACKING / Imballo



TECHNICAL DETAILS / Dettagli tecnici



## 370/G

Linking device  
Gancio di collegamento



FRAME  
Telaio

AA

ANODIZED ALUMINIUM  
Alluminio anodizzato

**€ 33,00** (each pc / cadauno)  
For chair / Per sedia:  
KOI-BOOKI

PACKING / Imballo



TECHNICAL DETAILS / Dettagli tecnici

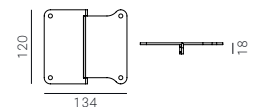

# 840

Linking device  
Gancio di collegamento



FRAME  
Telaio

NY

NYLON  
Nylon

**€ 8,00** (each pc / cadauno)  
For ICE chair and armchair  
Per sedia e poltrona ICE

PACKING / Imballo



TECHNICAL DETAILS / Dettagli tecnici

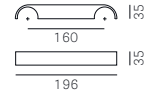

# 870/G

Linking device  
Gancio di collegamento



FRAME  
Telaio

NY

NYLON  
Nylon

**€ 7,00** (each pc / cadauno)  
For chair / Per sedia:  
JOI 870

PACKING / Imballo



TECHNICAL DETAILS / Dettagli tecnici

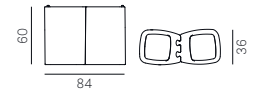

# 1101/GANCIO

Linking device  
Gancio di collegamento



FRAME  
Telaio

NY

NYLON  
Nylon

**€ 4,00**  
For chairs / Per sedie:  
KUADRA (20x20), KUADRA XL (20x20)  
For chairs / Per sedie:  
KUADRA (Ø16), TREND (Ø16)  
See item / Si veda articolo:  
790/G\_NE

TECHNICAL DETAILS / Dettagli tecnici

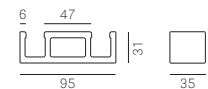

## IMP03

Panel for stacking  
Pannello per impilaggio



**POLYSTYRENE RIGID FOAM**  
Polistirolo rigido nero

**€ 22,00**

For upholstered and leather chair/armchair/stool:  
Per sedia/poltrona/sgabello imbottiti e in cuoio:  
KUADRA (Ø10, Ø16, 20x20),  
TREND (Ø10, Ø16)

**TECHNICAL DETAILS / Dettagli tecnici**

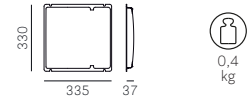

## IMP02

Panel for stacking  
Pannello per impilaggio



**POLYSTYRENE RIGID FOAM**  
Polistirolo rigido nero

**€ 25,00**

Upholstered KUADRA XL and INGA chairs and armchairs  
Sedie e poltrone KUADRA XL e INGA imbottite

**TECHNICAL DETAILS / Dettagli tecnici**

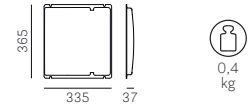

## IMP.CG.001

Panel for stacking  
Pannello per impilaggio



**FABRIC**  
Tessuto

**€ 22,00**

Upholstered and leather chairs and armchairs supplied with linking device CG  
Sedie e poltrone imbottite e in cuoio abbinato a gancio di collegamento CG  
KUADRA (Ø10, Ø16, 20X20)  
TREND (Ø10, Ø16)



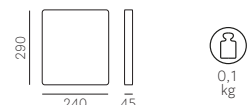











**TECHNICAL DETAILS / Dettagli tecnici**

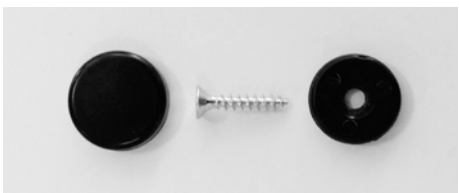

Density / Densità  
50 KG/MC



Glides for wooden seating  
Piedini per sedute in legno

CODE Codice	RECOMMENDED FOR THE FOLLOWING FLOORS: Raccomandati per i seguenti pavimenti:	PACKAGING Imballo	FELT Feltro	PLASTIC Plastica
 <p>FLT</p>	<p>Wood, ceramic and marble Legno, ceramica e marmo</p>	 MC 0,003  0,15 kg	<p><b>€ 33,00</b> (100 pcs/pz)</p> <p>Please mention the seating item code Si prega di specificare il codice della seduta</p>	
 <p>PIEDINO/15_100</p>	<p>Wood, ceramic and marble Legno, ceramica e marmo</p>	 MC 0,003  0,25 kg	<p><b>€ 55,00</b> (100 pcs/pz)</p> <p>to be ordered separately da ordinare separatamente</p>	
 <p>PIEDINO/15.1_100</p>		 MC 0,003  0,15 kg	<p><b>€ 39,00</b> (100 pcs/pz)</p> <p>to be ordered separately da ordinare separatamente</p>	
 <p>PIEDINO/17_100</p>	<p>Moquette, carpets, concrete and metal Moquette, tappeti, cemento e metallo</p>	 MC 0,003  0,25 kg		<p><b>€ 39,00</b> (100 pcs/pz)</p> <p>to be ordered separately da ordinare separatamente</p> <p><b>€ 9,00</b></p> <p>Upcharge each seating for preassembled glide Supplemento a seduta per piedino premontato</p>
 <p>PIEDINO/17.1_100</p>		 MC 0,003  0,15 kg		<p><b>€ 22,00</b> (100 pcs/pz)</p> <p>to be ordered separately da ordinare separatamente</p>

## 690/PIEDINO.POM\_40

**PLASTIC GLIDE**  
Piedino in materiale plastico



**€ 25,00**

(40 pcs/pz)

Suitable for moquette, carpets, linoleum or similar  
Adatto per moquette, tappeti, linoleum o simili

For chairs/armchairs/pouf / Per sedie/poltrone/pouf  
Ester (691, 690, 693)

**TECHNICAL DETAILS /** Dettagli tecnici

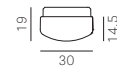

## 690/PIEDINO.FLT\_40

**PLASTIC GLIDE AND FELT**  
Piedino in materiale plastico e feltro



**€ 25,00**

(40 pcs/pz)

Suitable for wood, ceramic, marble or similar  
Adatto per legno, ceramica, marmo o simili

For chairs/armchairs/pouf / Per sedie/poltrone/pouf  
Ester (691, 690, 693)

**TECHNICAL DETAILS /** Dettagli tecnici

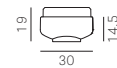

## MINIATURES\_A

Miniature



### POLYCARBONATE AND POLYPROPYLENE Policarbonato e polipropilene

€ 53,00

3pcs armchair / 3pz poltrona PASHA 660  
(BI, NE, TR)



3pcs armchair / 3pz poltrona PLUS 630  
(GA, SA, BI)



PACKING / Imballo



TECHNICAL DETAILS / Dettagli tecnici

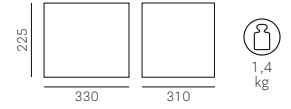

## MINIATURES\_315\_640

Miniature



### POLYCARBONATE AND POLYPROPYLENE Policarbonato e polipropilene

€ 53,00

3pcs armchair / 3pz poltrona ARA 315  
(BI, BL, GC)



3pcs chair / 3pz sedia BLITZ 640  
(TR, SA, RT)



PACKING / Imballo



TECHNICAL DETAILS / Dettagli tecnici

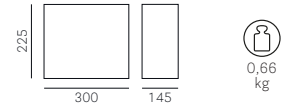

## MINIATURES\_260\_A

Miniature



**POLYPROPYLENE**  
Polipropilene

**€ 22,00**  
3pcs chair / 3pz sedia DOME 260  
(Bl, NE, VE)



**PACKING / Imballo**



MC 0,004

Package colour: petroleum blue  
Colore confezione: petrolio

**TECHNICAL DETAILS / Dettagli tecnici**

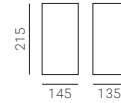

## MINIATURES\_260\_B

Miniature



**POLYPROPYLENE**  
Polipropilene

**€ 22,00**  
3pcs chair / 3pz sedia DOME 260  
(Bl, NE, VE)



**PACKING / Imballo**



MC 0,004

Package colour: light blue  
Colore confezione: azzurro

**TECHNICAL DETAILS / Dettagli tecnici**

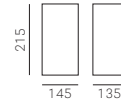

## MINIATURES\_260\_C

Miniature



**POLYPROPYLENE**  
Polipropilene

**€ 22,00**  
3pcs chair / 3pz sedia DOME 260  
(Bl, NE, VE)



**PACKING / Imballo**



MC 0,004

Package colour: peach  
Colore confezione: pesca

**TECHNICAL DETAILS / Dettagli tecnici**

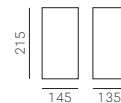

# Show-room displayers / Espositori per show-room

## EXPO-SEDIE



WHITE POWDER COATED  
verniciato bianco

NET PRICE  
Prezzo netto

€ 440,00

TECHNICAL DETAILS  
Dettagli tecnici

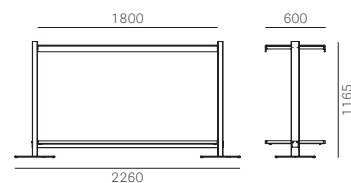

Capacity / Capacità

Upper methacrylate ledge  
Ripiano superiore in metacrilato  
n.3 items (30-40 kgs equally spread)  
n.3 prodotti (30-40 kg equamente distribuiti)

Lower melamine ledge  
Ripiano inferiore in nobilitato  
n.3 items (40-70 kgs equally spread)  
n.3 prodotti (40-70 kg equamente distribuiti)

## EXPO-SEDIE\_LINK



WHITE POWDER COATED  
verniciato bianco

NET PRICE  
Prezzo netto

€ 385,00

TECHNICAL DETAILS  
Dettagli tecnici

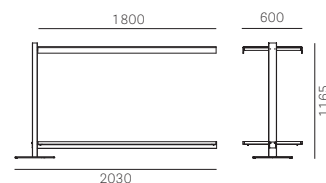

Capacity / Capacità

Upper methacrylate ledge  
Ripiano superiore in metacrilato  
n.3 items (30-40 kgs equally spread)  
n.3 prodotti (30-40 kg equamente distribuiti)

Lower melamine ledge  
Ripiano inferiore in nobilitato  
n.3 items (40-70 kgs equally spread)  
n.3 prodotti (40-70 kg equamente distribuiti)

## PEDANA\_200x100x15



BLACK MAT (NE) /  
WHITE SHINY LAMINATE (BI)  
Supplied with 6 adjustable feet

Laminato nero opaco (NE) /  
Bianco lucido (BI)  
con 6 piedini regolabili

NET PRICE  
Prezzo netto

€ 121,00

TECHNICAL DETAILS  
Dettagli tecnici

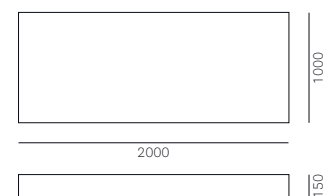

Capacity / Capacità

n.2/3 products  
n.2/3 prodotti

# Show-room displayers / Espositori per show-room

## P\_PEDRALI

Catalogue holder  
Portacataloghi



**FINISH**  
Finitura

PLEXIGLASS  
To be fixed to the wall  
Fissaggio a parete

**NET PRICE**  
Prezzo netto

**€ 110,00**

**TECHNICAL DETAILS**  
Dettagli tecnici

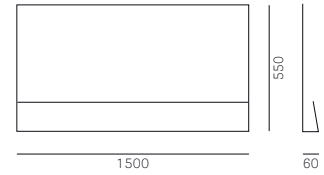

**Capacity / Capacità**

n. 6 kind of catalogues (n.10 pieces each)  
n. 6 tipi di cataloghi (n°10 pezzi per tipo)

## 4401/ACP

Bags-hanger  
Portaborse



**FINISH**  
Finitura

BRUSHED STAINLESS STEEL  
Acciaio inox satinato

**NET PRICE**  
Prezzo netto

**€ 161,00**

**TECHNICAL DETAILS**  
Dettagli tecnici

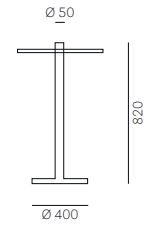

## 5141B

Bags-hanger  
Portaborse



**FINISH**  
Finitura

WHITE/BLACK POWDER COATED  
verniciato bianco/nero

**NET PRICE**  
Prezzo netto

**€ 132,00**

**TECHNICAL DETAILS**  
Dettagli tecnici

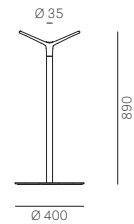

## CARRELLO

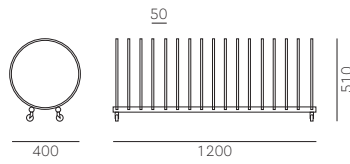

FINISH Finitura	NET PRICE Prezzo netto	TECHNICAL DETAILS Dettagli tecnici
WHITE POWDER COATED Verniciato bianco	<b>€ 110,00</b>	 <p>Capacity / Capacità</p> <p>n.16 tops n.16 ripiani</p>

## TOTEM\_100x250

Totem one sided  
Totem monofacciale

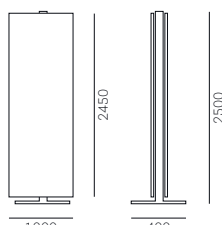

FINISH Finitura	NET PRICE Prezzo netto	TECHNICAL DETAILS Dettagli tecnici
WHITE POWDER COATED Verniciato bianco	<b>€ 270,00</b> With printed expanded pvc board Comprensivo di pannello in forex stampato	

## TOTEM\_2x100x250



Totem two sided  
Totem bifacciale

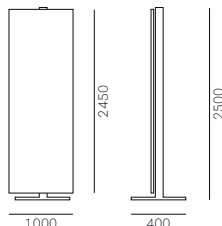

FINISH Finitura	NET PRICE Prezzo netto	TECHNICAL DETAILS Dettagli tecnici
WHITE POWDER COATED Verniciato bianco	<b>€ 407,00</b> With 2 printed expanded pvc boards Comprensivo di 2 pannelli in forex stampato	

## ADESIVO

Window sticker  
Adesivo prespaziato per vetrina

FINISH Finitura	NET PRICE Prezzo netto	TECHNICAL DETAILS Dettagli tecnici
<p>ADESIVO 40x4</p>  <p>ADESIVO 200x21</p>	<p>€ 6,00</p> <p>€ 44,00</p>	 

## 100x200\_GRAF

Graphics  
Grafiche

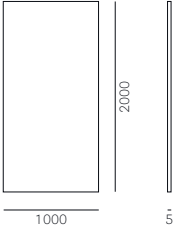
FINISH Finitura	NET PRICE Prezzo netto	TECHNICAL DETAILS Dettagli tecnici
 <p>WALL SOLUTION GRAPHICS Pannello per applicazione a parete</p> <p>Black (COD.H5) / White (COD.H6) Nero (COD.H5) / Bianco (COD.H6)</p>	<p>€ 106,00</p>	

## 100x245\_GRAF

Graphics  
Grafiche

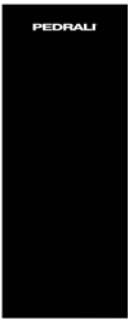
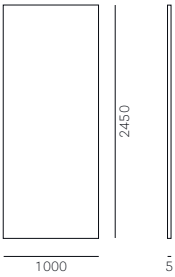
FINISH Finitura	NET PRICE Prezzo netto	TECHNICAL DETAILS Dettagli tecnici
 <p>WALL/TOTEM SOLUTION GRAPHICS Pannello per applicazione a parete o per totem</p> <p>Black (COD.H5) / White (COD.H6) Nero (COD.H5) / Bianco (COD.H6)</p>	<p>€ 116,00</p>	



# Show-room displayers / Espositori per show-room

## 100x100\_GRAF (COD.I1)

Graphics  
Grafiche

**FINISH**  
Finitura

**NET PRICE**  
Prezzo netto

**TECHNICAL DETAILS**  
Dettagli tecnici



WALL SOLUTION GRAPHICS  
Pannello per applicazione a parete  
Black (COD.I1) / White (COD.I3)  
Nero (COD.I1) / Bianco (COD.I3)

**€ 49,00**

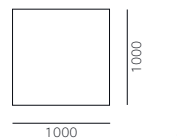

## 150x100\_GRAF (COD.I2)

Graphics  
Grafiche

**FINISH**  
Finitura

**NET PRICE**  
Prezzo netto

**TECHNICAL DETAILS**  
Dettagli tecnici



WALL SOLUTION GRAPHICS  
Pannello per applicazione a parete  
Black (COD.I2) / White (COD.I4)  
Nero (COD.I2) / Bianco (COD.I4)

**€ 72,00**

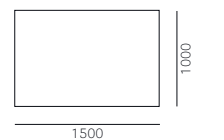



## Finishes / Finiture

Lacquered wood with visible grains / Legno laccato a poro aperto

---

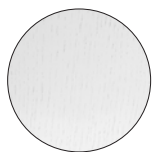

**BI**  
White  
Bianco

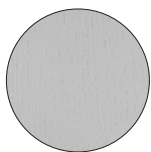

**GC**  
Light grey  
Grigio chiaro

PANTONE 400 U



**AN**  
Black  
Nero

PANTONE Black U



**BL2**  
Dark blue  
Blu scuro

PANTONE 539 U

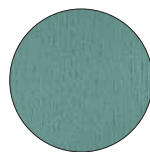

**AZ1**  
Light blue  
Azzurro

PANTONE 5503 U

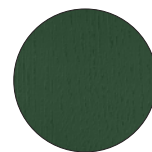

**VE2**  
Dark green  
Verde scuro

PANTONE 342 U

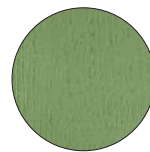

**VE1**  
Light green  
Verde chiaro

PANTONE 556 U

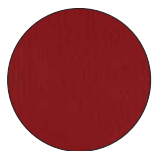

**RB**  
Ruby red  
Rosso rubino

PANTONE 1805 U

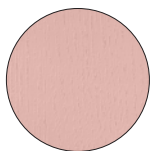

**RA**  
Pink  
Rosa

PANTONE 693 U



**MO**  
Mahogany  
Mogano

PANTONE 7603 U



**MC**  
Cognac  
Cognac

PANTONE 1675 U

Colours are indicative. Pedrali reserves the right to modify or upgrade the product without prior notice.  
I colori sono indicativi. Pedrali si riserva la facoltà di apportare modifiche o migliorie senza alcun preavviso.

# Finishes / Finiture

## Steel and stainless steel / Acciaio e acciaio inox

---

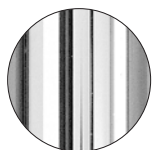

**CR**  
Chromed steel  
Acciaio cromato



**ST**  
Satinized steel  
Acciaio satinato



**CO**  
Matt chromed steel  
Acciaio cromato opaco

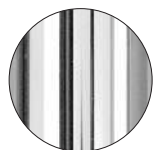

**LU**  
Polished s/steel  
Acciaio inox lucidato

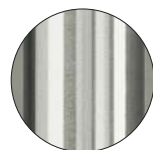

**AC**  
Brushed s/steel  
Acciaio inox satinato

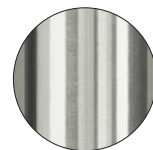

**AC 316**  
Brushed s/steel AISI 316  
for outdoor  
Acciaio inox AISI 316 per  
esterno



**BS**  
Antique bronze steel  
Acciaio bronzo anticato

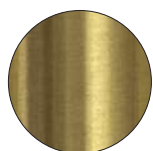

**OA**  
Antique brass steel  
Acciaio ottone anticato

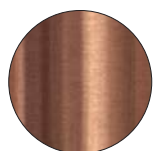

**RM**  
Antique copper steel  
Acciaio rame anticato



**TN**  
Titanium steel  
Acciaio finitura titanio

## Gold lacquered / Laccato oro

---



**VOR**

## Nickel / Nichel

---

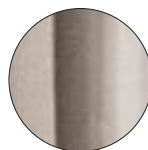

**AS**  
Brushed nickel  
Nichel satinato

## Aluminium / Alluminio

---



**LU**  
Polished aluminium  
Alluminio lucidato

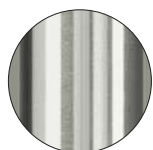

**AS**  
Satinized aluminium  
Alluminio satinato



**AA**  
Anodized aluminium  
Alluminio anodizzato



**TN**  
Titanium  
Titanio

Colours are indicative. Pedrali reserves the right to modify or upgrade the product without prior notice.  
I colori sono indicativi. Pedrali si riserva la facoltà di apportare modifiche o migliorie senza alcun preavviso.

# Indoor finishes / Finiture per interno

Powder coated cast-iron, steel and aluminium / Ghisa, acciaio e alluminio verniciato



**BI100**

White,  
textured-matt finish  
Bianco,  
finitura goffrata-opaca



**BI200**

White,  
textured-matt finish  
Bianco,  
finitura goffrata-opaca

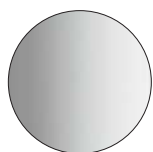

**BI300**

White,  
smooth-matt finish  
Bianco,  
finitura liscia-opaca

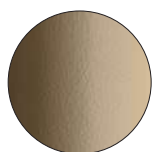

**SA100**

Sand,  
textured-matt finish  
Sabbia,  
finitura goffrata-opaca



**SA200**

Sand,  
textured-matt finish  
Sabbia,  
finitura goffrata-opaca

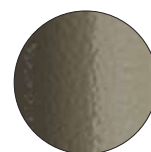

**SA300**

Sand,  
hammered-glossy finish  
Sabbia,  
finitura bucciata-lucida

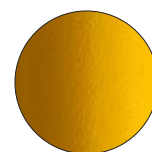

**GI100**

Yellow,  
textured-matt finish  
Giallo,  
finitura goffrata-opaca



**AR200**

Orange,  
textured-matt finish  
Arancio,  
finitura goffrata-opaca

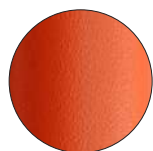

**AR500**

Orange,  
textured-matt finish  
Arancio,  
finitura goffrata-opaca

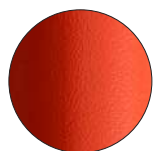

**AR400**

Orange,  
textured-matt finish  
Arancio,  
finitura goffrata-opaca

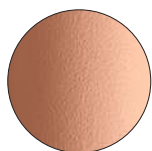

**RA100**

Pink,  
textured-matt finish  
Rosa,  
finitura goffrata-opaca



**RO400**

Red,  
textured-matt finish  
Rosso,  
finitura goffrata-opaca



**RO200**

Red,  
textured-matt finish  
Rosso,  
finitura goffrata-opaca

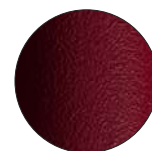

**RO300**

Red,  
textured-matt finish  
Rosso,  
finitura goffrata-opaca



**TE**

Terracotta,  
textured-matt finish  
Terracotta,  
finitura goffrata-opaca



**RU**

Rust,  
textured-matt finish  
Ruggine,  
finitura goffrata-opaca



**MG**

Brown,  
textured-matt finish  
Marrone,  
finitura goffrata-opaca

Colours are indicative. Pedrali reserves the right to modify or upgrade the product without prior notice.  
I colori sono indicativi. Pedrali si riserva la facoltà di apportare modifiche o migliorie senza alcun preavviso.

# Indoor finishes / Finiture per interno

Powder coated cast-iron, steel and aluminium / Ghisa, acciaio e alluminio verniciato

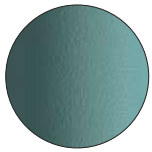

**AZ100**  
Light blue,  
textured-matt finish  
Azzurro,  
finitura goffrata-opaca

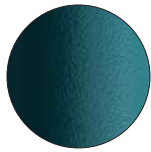

**BL500**  
Blue,  
textured-matt finish  
Blu,  
finitura goffrata-opaca

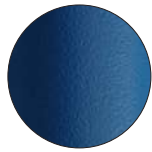

**BL300**  
Blue,  
textured-matt finish  
Blu,  
finitura goffrata-opaca



**BL400**  
Blue,  
textured-matt finish  
Blu,  
finitura goffrata-opaca

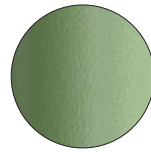

**VE100**  
Sage green,  
textured-matt finish  
Verde salvia,  
finitura goffrata-opaca

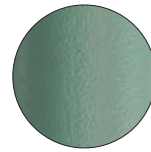

**VE600**  
Green,  
textured-matt finish  
Verde,  
finitura goffrata-opaca



**VE300**  
Forest green soft-touch,  
smooth-matt finish  
Verde bosco soft-touch,  
finitura liscia-opaca



**6005**  
Green,  
smooth-glossy finish  
Verde,  
finitura liscia-lucida



**VE400**  
Green,  
textured-matt finish  
Verde,  
finitura goffrata-opaca



**BE100**  
Beige,  
textured-matt finish  
Beige,  
finitura goffrata-opaca



**BE200**  
Beige,  
textured-matt finish  
Beige,  
finitura goffrata-opaca

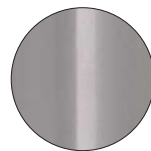

**AL**  
Aluminium,  
smooth-glossy finish  
Alluminio,  
finitura liscia-lucida



**9007**  
Aluminium,  
smooth-matt finish  
Alluminio,  
finitura liscia-opaca



**AG**  
Aluminium,  
textured-matt finish  
Alluminio,  
finitura goffrata-opaca



**GA**  
Anthracite grey,  
textured-matt finish  
Grigio antracite,  
finitura goffrata-opaca



**GN**  
Natural grey,  
textured-matt finish  
Grigio naturale,  
finitura goffrata-opaca



**\_NERO**  
Black,  
hammered-matt finish  
Nero,  
finitura bucciata-opaca

Colours are indicative. Pedrali reserves the right to modify or upgrade the product without prior notice.  
I colori sono indicativi. Pedrali si riserva la facoltà di apportare modifiche o migliorie senza alcun preavviso.

# Outdoor finishes / Finiture per esterno



Powder coated cast-iron, steel and aluminium / Ghisa, acciaio e alluminio verniciato



**BI100E**  
White,  
textured-matt finish  
Bianco,  
finitura goffrata-opaca



**BI200E**  
White,  
textured-matt finish  
Bianco,  
finitura goffrata-opaca

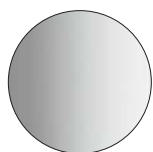

**BI300E**  
White,  
smooth-matt finish  
Bianco,  
finitura liscia-opaca



**SA100E**  
Sand,  
textured-matt finish  
Sabbia,  
finitura goffrata-opaca



**SA200E**  
Sand,  
textured-matt finish  
Sabbia,  
finitura goffrata-opaca

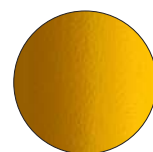

**GI100E**  
Yellow,  
textured-matt finish  
Giallo,  
finitura goffrata-opaca

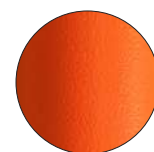

**AR200E**  
Orange,  
textured-matt finish  
Arancio,  
finitura goffrata-opaca

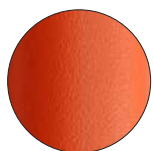

**AR500E**  
Orange,  
textured-matt finish  
Arancio,  
finitura goffrata-opaca

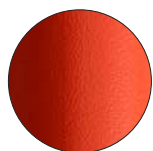

**AR400E**  
Orange,  
textured-matt finish  
Arancio,  
finitura goffrata-opaca

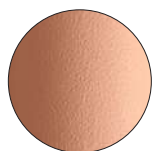

**RA100E**  
Pink,  
textured-matt finish  
Rosa,  
finitura goffrata-opaca



**RO400E**  
Red,  
textured-matt finish  
Rosso,  
finitura goffrata-opaca

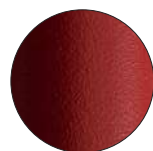

**RO200E**  
Red,  
textured-matt finish  
Rosso,  
finitura goffrata-opaca



**RO300E**  
Red,  
textured-matt finish  
Rosso,  
finitura goffrata-opaca

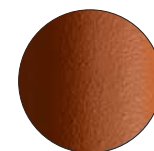

**TEE**  
Terracotta,  
textured-matt finish  
Terracotta,  
finitura goffrata-opaca



**RUE**  
Rust,  
textured-matt finish  
Ruggine,  
finitura goffrata-opaca



**MGE**  
Brown,  
textured-matt finish  
Marrone,  
finitura goffrata-opaca



**AZ100E**  
Light blue,  
textured-matt finish  
Azzurro,  
finitura goffrata-opaca

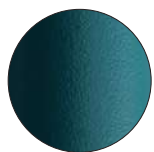

**BL500E**  
Blue,  
textured-matt finish  
Blu,  
finitura goffrata-opaca

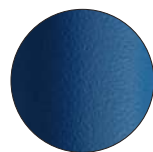

**BL300E**  
Blue,  
textured-matt finish  
Blu,  
finitura goffrata-opaca

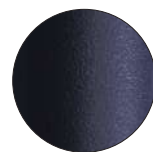

**BL400E**  
Blue,  
textured-matt finish  
Blu,  
finitura goffrata-opaca

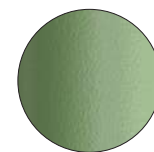

**VE100E**  
Sage green,  
textured-matt finish  
Verde salvia,  
finitura goffrata-opaca

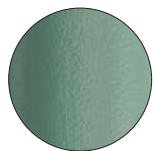

**VE600E**  
Green,  
textured-matt finish  
Verde,  
finitura goffrata-opaca



**VE300E**  
Forest green,  
textured-matt finish  
Verde bosco,  
finitura goffrata-opaca

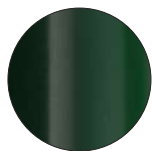

**6005E**  
Green,  
smooth-glossy finish  
Verde,  
finitura liscia-lucida



**BE100E**  
Beige,  
textured-matt finish  
Beige,  
finitura goffrata-opaca



**BE200E**  
Beige,  
textured-matt finish  
Beige,  
finitura goffrata-opaca

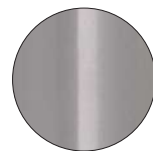

**ALE**  
Aluminium,  
smooth-glossy finish  
Alluminio,  
finitura liscia-lucida



**9007E**  
Aluminium,  
smooth-matt finish  
Alluminio,  
finitura liscia-opaca



**AGE**  
Aluminium,  
textured-matt finish  
Alluminio,  
finitura goffrata-opaca



**GAE**  
Anthracite grey,  
textured-matt finish  
Grigio antracite,  
finitura goffrata-opaca



**GNE**  
Natural grey,  
textured-matt finish  
Grigio naturale,  
finitura goffrata-opaca



**NPE**  
Black,  
textured-matt finish  
Nero,  
finitura goffrata-opaca

Colours are indicative. Pedrali reserves the right to modify or upgrade the product without prior notice.  
I colori sono indicativi. Pedrali si riserva la facoltà di apportare modifiche o migliorie senza alcun preavviso.

## Category A

Simil leather / Finta pelle

---



A96



A95



A94



A92

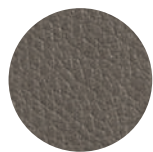

A93

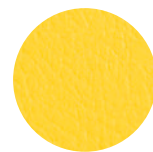

A73

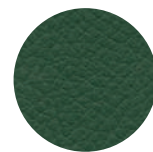

A89

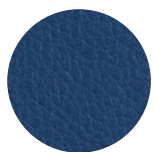

A80



A72



A91



A90



A71

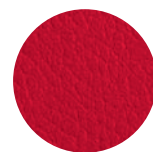

A82

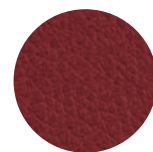

A70

## Category B

Nylon / Nylon

---

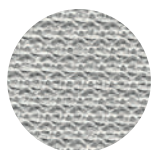

B01



B02

For Island item 795-796-797  
Per Island art. 795-796-797



# Category C

Fabric / Tessuto

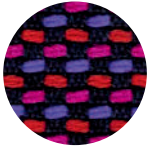

C36



C37

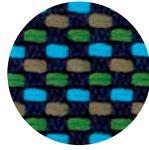

C38

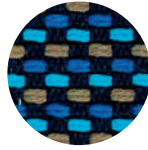

C39

For Arki-Stool, Babila XL, Ikon low stool, Noa, Tweet, Wow, Buddy and the following cushions only:  
**Social Plus, Blitz, Buddy, Queen, Pasha, Gliss and Ikon bench.**  
 Solo per Arki-Stool, Babila XL, Ikon low stool, Noa, Tweet, Wow, Buddy e per i seguenti cuscini:  
 Social Plus, Blitz, Buddy, Queen, Pasha, Gliss e Ikon bench

Fire retardant fabric / Tessuto ignifugo

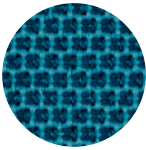

C83

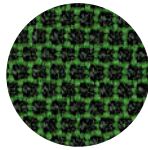

C84

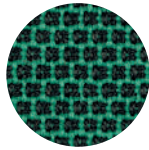

C88

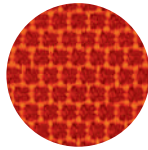

C85

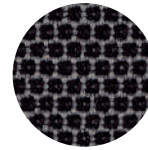

C86

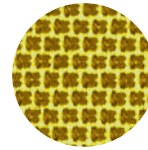

C87

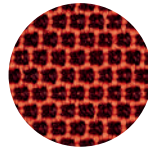

C89

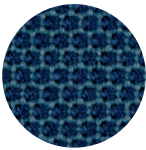

C100



C101

- **FLAME RESISTANCE / RESISTENZA AL FUOCO**  
 BS EN 1021 1&2  
 BS EN 1021-1  
 ÖNORM A3800-1  
 US CA TB 117-2013

Colours are indicative. Pedrali reserves the right to modify or upgrade the product without prior notice.  
 I colori sono indicativi. Pedrali si riserva la facoltà di apportare modifiche o migliorie senza alcun preavviso.



Fire retardant fabric / Tessuto ignifugo



C110

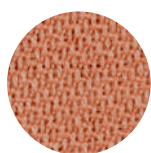

C111



C112



C113

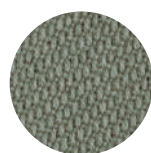

C114

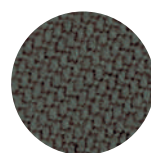

C115



C116

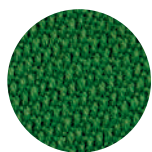

C117

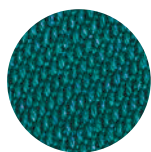

C118

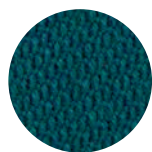

C119

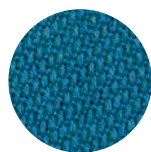

C120

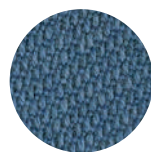

C121

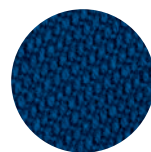

C122

• COLLECTION / COLLEZIONE  
 **svensson** - SEMI

• FLAME RESISTANCE / RESISTENZA AL FUOCO  
BS 5852 Crib 5  
EN ISO 1021 Part 1&2  
IMO FTP Code 2010: Part 8  
UNI 9175 Classe 1 IM  
US CA TB 117-2013



Fire retardant fabric / Tessuto ignifugo

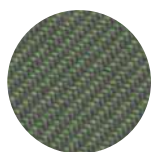

C210



C211



C212



C213



C214

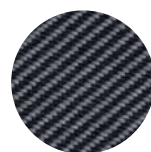

C215

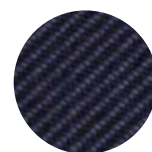

C216

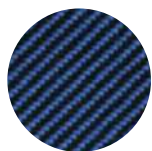

C217

• COLLECTION / COLLEZIONE  
**kvadrat** - RELATE  
DESIGNER Patricia Urquiola

• FLAME RESISTANCE / RESISTENZA AL FUOCO  
AS/NZS 3837, class 2  
BS 5852 Crib 5  
BS 5852 Part 1 with treatment  
DIN 4102 B1  
EN 1021-1/2  
IMO FTP Code 2010: Part 8  
NF D60-013  
NF P92 507 M1  
NFPA 701  
ÖNORM B1/Q1  
SN 198 898 5.2  
UNI 9175 Classe 1 IM  
UNI 9177 Classe 1  
US CA TB 117-2013

Colours are indicative. Pedrali reserves the right to modify or upgrade the product without prior notice.  
I colori sono indicativi. Pedrali si riserva la facoltà di apportare modifiche o migliorie senza alcun preavviso.



Fire retardant simil leather / Finta pelle ignifuga



C18

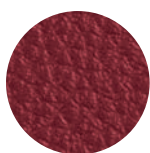

C11

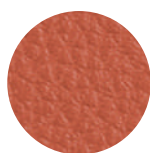

C12

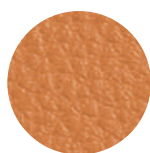

C13

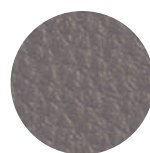

C15

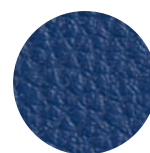

C10



C17



C14



C21



C20



C22

- **FLAME RESISTANCE / RESISTENZA AL FUOCO**  
 B2 (DIN 4102)  
 BS 5852 Crib 5  
 EN 1021.1-2  
 EN 13501-1 - Cs3do  
 FAR 25853 App F Part 1  
 IMO RESOLUTION A.652  
 NF D60-013 - AM 18  
 NFP 92503 M1  
 NY/NJ - Port Authority  
 UFAC Fabric Class 1  
 German fire standard B1 (except C12 and C22)  
 US CA TB 117-2013  
 US CA TB 133



Fire retardant simil leather / Finta pelle ignifuga



C130



C131



C132

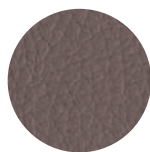

C133



C134

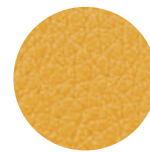

C135

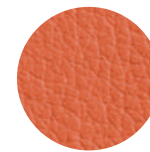

C136

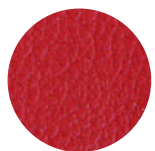

C137

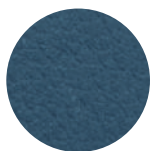

C138

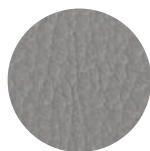

C139



C140



C141

- **FLAME RESISTANCE / RESISTENZA AL FUOCO**  
 BS 5852-1 match test  
 EN 1021 Part 1-2  
 UNI 9175 Classe 1 IM  
 US CA TB 117-2013

Colours are indicative. Pedrali reserves the right to modify or upgrade the product without prior notice.  
I colori sono indicativi. Pedrali si riserva la facoltà di apportare modifiche o migliorie senza alcun preavviso.



## Fire retardant simil leather / Finta pelle ignifuga

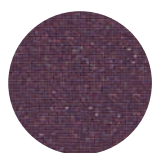

C60

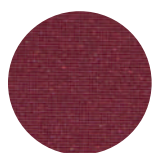

C61

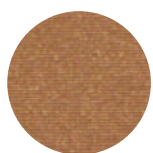

C62



C63

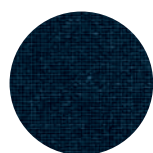

C64



C90



C94



C95

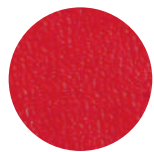

C92



C91



C93

- **FLAME RESISTANCE / RESISTENZA AL FUOCO**  
BS 5852-1 Part 1  
EN 1021-2  
IMO RESOLUTION A.652 (16): 1989  
UNI 9175 Classe 1 IM  
US CA TB 117-2013

## Category D



### Fire retardant fabric / Tessuto ignifugo

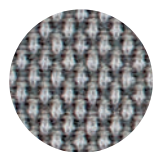

D40



D41

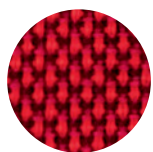

D42

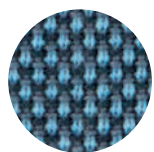

D43

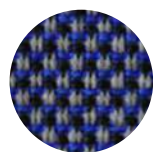

D44

- **FLAME RESISTANCE / RESISTENZA AL FUOCO**  
BS EN 1021 1&2  
BS 5852 Part 1 0, 1  
UNI 9175 Classe 1 IM  
US CA TB 117-2013

### Fabric / Tessuto



D120



D121



D122



D123

- **FLAME RESISTANCE / RESISTENZA AL FUOCO**  
BS 5852 Part 1  
US CA TB 117-2013

Colours are indicative. Pedrali reserves the right to modify or upgrade the product without prior notice.  
I colori sono indicativi. Pedrali si riserva la facoltà di apportare modifiche o migliorie senza alcun preavviso.



Fabric / Tessuto



D22



D23



D24



D25



D26

• COLLECTION / COLLEZIONE  
**PEDRALI** - BREZZA



Fabric / Tessuto

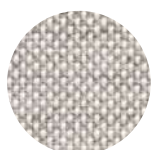

D80

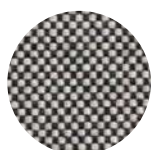

D81

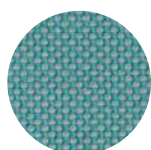

D82

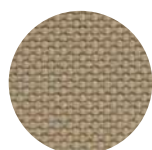

D83



D84

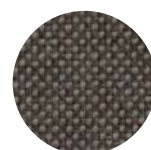

D85

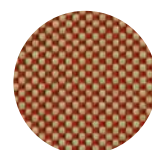

D86

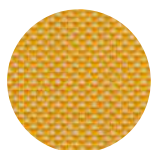

D87



D88

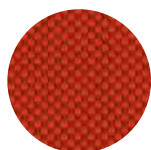

D89

• COLLECTION / COLLEZIONE  
**PEDRALI** - FLORIDA



Fabric / Tessuto

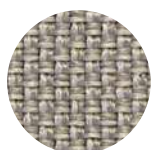

D100



D101

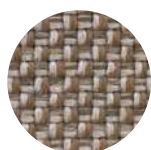

D105



D102

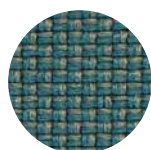

D103

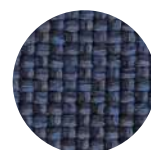

D104

• COLLECTION / COLLEZIONE  
**PEDRALI** - ZEFIRO



Fabric / Tessuto



D110



D111



D112



D113

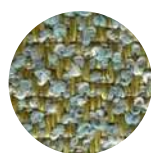

D114



D115

• COLLECTION / COLLEZIONE  
**PEDRALI** - SAND



Fabric / Tessuto



D130



D131

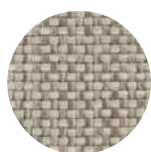

D132



D133

## Category E

Velvet / Velluto

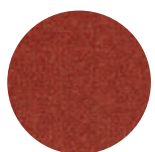

E01



E06



E02



E07



E08

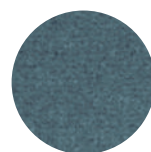

E04

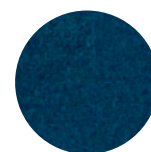

E03

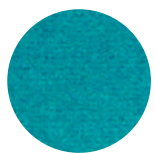

E05



E09

• COLLECTION / COLLEZIONE  
**DEDAR** - ADAMO & EVA  
RIANO

Colours are indicative. Pedrali reserves the right to modify or upgrade the product without prior notice.  
I colori sono indicativi. Pedrali si riserva la facoltà di apportare modifiche o migliorie senza alcun preavviso.

# Category F

Genuine leather / Cuoio naturale

---



F05



F01



F04

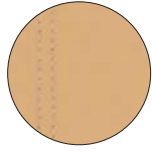

F03

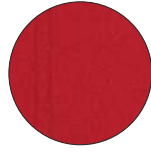

F06

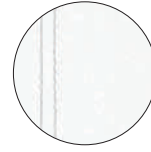

F07

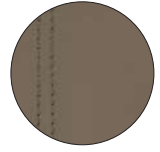

F08



F09

Regenerated leather / Cuoio rigenerato

---



F11



F12



F13

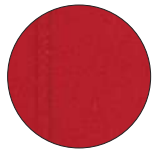

F17



F18

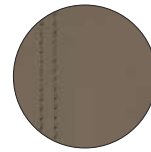

F19

Colours are indicative. Pedrali reserves the right to modify or upgrade the product without prior notice.  
I colori sono indicativi. Pedrali si riserva la facoltà di apportare modifiche o migliorie senza alcun preavviso.

## Category G

Fire retardant wool / Lana ignifuga



G21

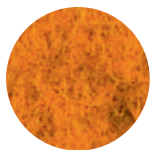

G22

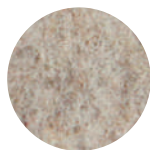

G24

- COLLECTION / COLLEZIONE  
**kvadrat** - DIVINA MELANGE  
DESIGNER Finn Skødt

- FLAME RESISTANCE / RESISTENZA AL FUOCO  
AS/NZS 1530.3  
ASTM E84 Class B Unadhered  
ASTM E84 Class A Adhered  
BS 5852 Part 1  
BS 5867 part 2 type B  
CAN ULC S109 with treatment  
EN 1021-1/2  
EN 13501, B-s2, d0 with treatment  
IMO FTP Code 2010: Part 8  
NF D60-013  
NFPA 260  
NFPA 701 with treatment  
ÖNORM B1/ Q1  
SN 198 898 5.3 with treatment  
UNI 9175 Classe 1 IM  
US CA TB 117-2013

Fire retardant wool / Lana ignifuga

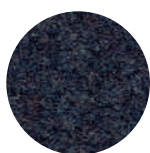

G110

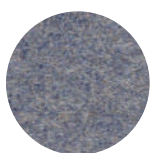

G111

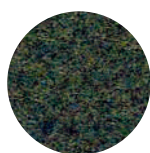

G112



G114



G115



G116

- COLLECTION / COLLEZIONE  
**kvadrat** - DIVINA MD  
DESIGNER Finn Skødt

- FLAME RESISTANCE / RESISTENZA AL FUOCO  
AS/NZS 1530.3  
ASTM E84 Class B Unadhered  
ASTM E84 Class A Adhered  
BS 5852 Crib 5 with treatment  
BS 5852 Part 1  
BS 5867 part 2 type B  
CAN ULC S109 with treatment  
EN 1021-1/2  
EN 13501, B-s2, d0 with treatment  
IMO FTP Code 2010: Part 8  
NF D60-013  
NFPA 260  
NFPA 701 with treatment  
ÖNORM B1/ Q1  
SN 198 898 5.3 with treatment  
UNI 9175 Classe 1 IM  
US CA TB 117-2013

Colours are indicative. Pedrali reserves the right to modify or upgrade the product without prior notice.  
I colori sono indicativi. Pedrali si riserva la facoltà di apportare modifiche o migliorie senza alcun preavviso.



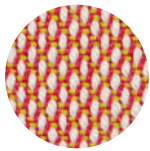

G59

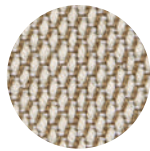

G66

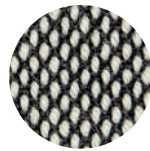

G63

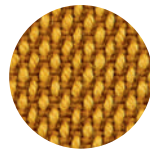

G67

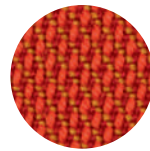

G69

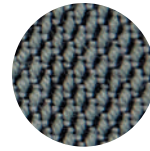

G62

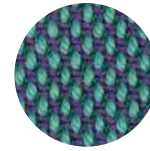

G68

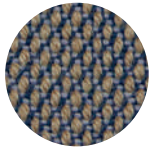

G64



G65

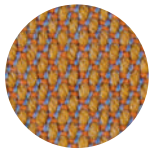

G190

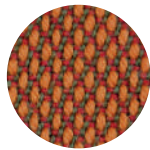

G191

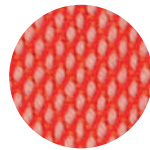

G192

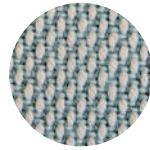

G193

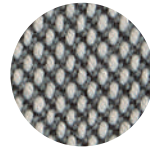

G194

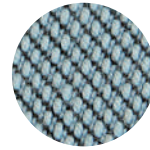

G195

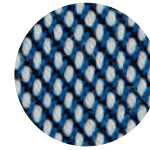

G196

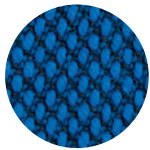

G197

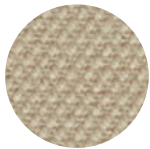

G71

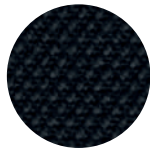

G70

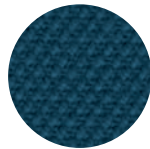

G75

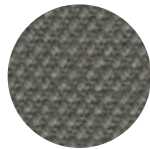

G73

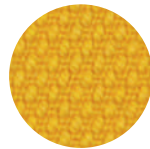

G78

• COLLECTION / COLLEZIONE

**kvadrat**

STEELCUT TRIO

G59+G69; G190+G197

STEELCUT

G70+G78

DESIGNER Dijkmeijer & Ridolfo

• FLAME RESISTANCE / RESISTENZA AL FUOCO

AS/NZS 1530.3

BS 5852 Part 1

BS 5852 Crib 5 with treatment

EN 1021 – 1/2

IMO FTP Code 2010: Part 8

NF D60-013

NFPA 260

SN 198 898 5.3 with treatment

UNI 9175 Classe 1 IM

US CA TB 117-2013

for G59+G69; G190+G197:

AS/NZS 3837 Class 2

BS 5852 IGNITION SOURCE 3

GB 50222 B1 with treatment

ÖNORM B1/Q1



Fire retardant fabric / Tessuto ignifugo

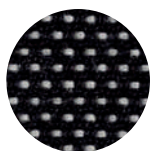

G100

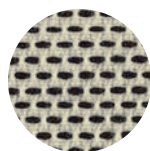

G101

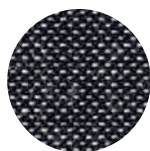

G102

- COLLECTION / COLLEZIONE

**kvadrat** - BASEL

DESIGNER Herzog & de Meuron

- FLAME RESISTANCE / RESISTENZA AL FUOCO

AS/NZS 3837 Class 2  
 BS 5852 Part 1  
 BS 5852 Crib 5 with treatment  
 EN 1021 – 1/2  
 GB 50222 B1 with treatment  
 IMO FTP Code 2010: Part 8

NFPA 260  
 NF D60-013  
 ÖNORM B1/Q1  
 SN 198 898 5.3 with treatment  
 UNI 9175 Classe 1 IM  
 US CA TB 117-2013



Fire retardant fabric / Tessuto ignifugo



G120

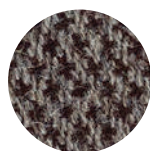

G121

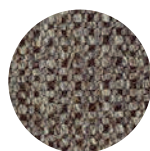

G122

- COLLECTION / COLLEZIONE

**kvadrat** - MOLLY

DESIGNER Åsa Pärson

- FLAME RESISTANCE / RESISTENZA AL FUOCO

BS 5852 Part 1  
 BS 5852 Crib 5 with treatment  
 EN 1021 – 1/2  
 IMO FTP Code 2010: Part 8

NFPA 260  
 NF D60-013  
 ÖNORM B1/Q1  
 UNI 9175 Classe 1 IM  
 US CA TB 117-2013



Fire retardant fabric / Tessuto ignifugo

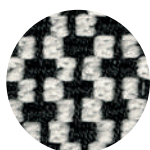

G130

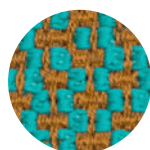

G131

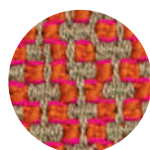

G132

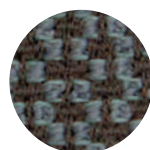

G133

- FLAME RESISTANCE / RESISTENZA AL FUOCO

BS 5852:1979 (Part 1)  
 BS 5852:2006 (Part 2) Crib 5  
 DIN 4102-1 B2  
 EN 1021 –1 and –2  
 EN 13501-1  
 FAR 25.853 (12 sec. vertical)  
 IMO: 2014/90/EU (MED)  
 UNI 9175 Classe 1 IM  
 US CA TB 117-2013

Fire retardant fabric / Tessuto ignifugo

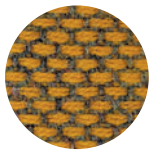

G140

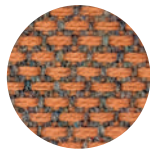

G141

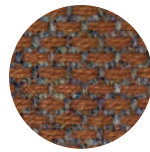

G142



G143



G144

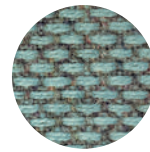

G145



G146

- COLLECTION / COLLEZIONE

**kvadrat** - RE-WOOL

DESIGNER Margrethe Odgaard

- FLAME RESISTANCE / RESISTENZA AL FUOCO

AS/NZS 1530.3

AS/NZS 3837 Class 2

BS 5852 Part 1

BS 5852 Crib 5 with treatment

BS 5852 IGNITION SOURCE 3

EN 1021 - 1/2

IMO FTP Code 2010: Part 8

NF D60-013

ÖNORM B1/Q1

UNI 9175 Classe 1IM

US CA TB 117-2013

Fire retardant fabric / Tessuto ignifugo

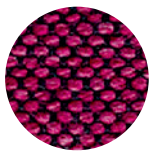

G150

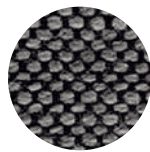

G151

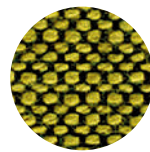

G152

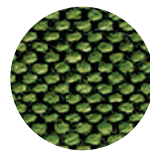

G153

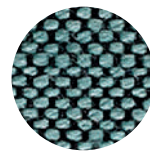

G154

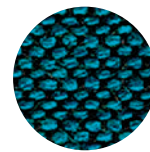

G155

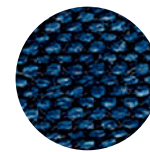

G156

- COLLECTION / COLLEZIONE

**svensson** - BALANCE

- FLAME RESISTANCE / RESISTENZA AL FUOCO

BS 5852 Crib 5

EN ISO 1021 Part 1&2

IMO FTP Code 2010: Part 8

UNI 9175 Classe 1 IM

US CA TB 117-2013

Fire retardant fabric / Tessuto ignifugo

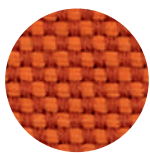

G170

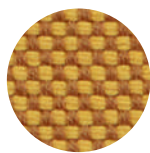

G171

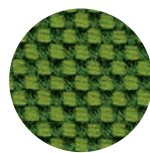

G172

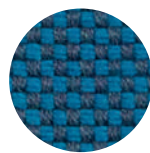

G173

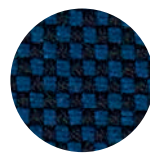

G174

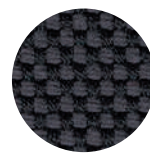

G175

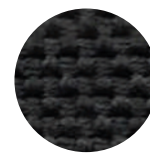

G176



G210

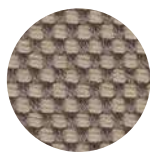

G211

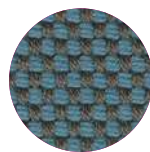

G212

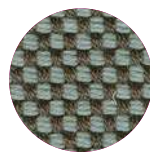

G213

- FLAME RESISTANCE / RESISTENZA AL FUOCO

BS 5852:1979 (Part 1)

BS 5852:2006 (Part 2) Crib 5

DIN 4102-1 B2

EN 13501-1

EN 1021 -1 and -2

FAR 25.853 (12 sec. vertical)

IMO: 2014/90/EU (MED)

UNI 9175 Classe 1 IM

US CA TB 117-2013

Colours are indicative. Pedrali reserves the right to modify or upgrade the product without prior notice.  
I colori sono indicativi. Pedrali si riserva la facoltà di apportare modifiche o migliorie senza alcun preavviso.

Fire retardant fabric / Tessuto ignifugo



G200



G201



G202



G203

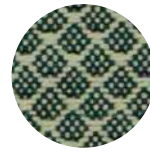

G204

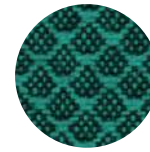

G205

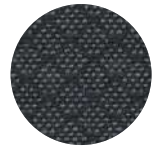

G206

- COLLECTION / COLLEZIONE  
**kvadrat** - JAALI  
DESIGNER Doshi Levien

- FLAME RESISTANCE / RESISTENZA AL FUOCO  
AS/NZS 1530.3  
BS 5852 Part 1  
BS 5852 Crib 5 with treatment  
BS 5852 IGNITION SOURCE 3  
EN 1021-1/2

IMO FTP Code 2010: Part 8  
NF D60-013  
SN 198 898 5.3 with treatment  
UNI 9175 Classe 1IM  
US CA TB 117-2013

Fire retardant fabric / Tessuto ignifugo



G220

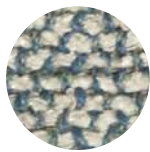

G221



G222



G223



G224



G225

- COLLECTION / COLLEZIONE  
**kvadrat** - SAHCO  
MOSS  
DESIGNER Vincent Van Duysen

- FLAME RESISTANCE / RESISTENZA AL FUOCO  
BS 5852 Part 1  
BS 5852 Crib 5 with treatment  
EN 1021-1/2  
US CA TB 117-2013

Fire retardant fabric / Tessuto ignifugo



G07

- FLAME RESISTANCE / RESISTENZA AL FUOCO  
BS EN 1021 1&2  
BS EN 1021-1  
ÖNORM A3800-B2-B3825-Q1 UK  
NFP 92-503 M3  
US CA TB 117-2013

Fire retardant fabric / Tessuto ignifugo



G160



G161



G162



G163



G164

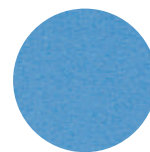

G165

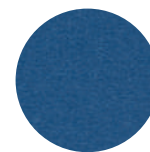

G166



G167



G168



G169

- COLLECTION / COLLEZIONE  
**kvadrat** - HERO  
DESIGNER Patricia Urquiola

- FLAME RESISTANCE /  
RESISTENZA AL FUOCO  
AS/NZS 3837 Class 2  
BS 5852 Crib 5 with treatment  
BS 5852 Part 1  
EN 1021 - 1/2  
IMO FTP Code 2010: Part 7  
with treatment  
IMO FTP Code 2010: Part 8  
NF D60-013  
SN 198 898 5.3 with treatment  
UNI 9175 Classe 1 IM  
US CA TB 117-2013

Fire retardant velvet / Velluto ignifugo



G180



G181

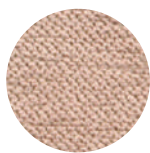

G182

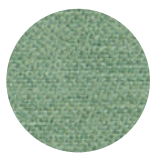

G183

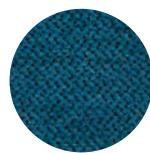

G184

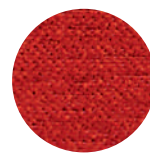

G185

- COLLECTION / COLLEZIONE  
**kvadrat** - STILL  
DESIGNER Georgina Wright

- FLAME RESISTANCE / RESISTENZA AL FUOCO  
ASTM E84 Class A  
BS 5852 Crib 5  
BS 5852 Part 1  
BS 5867 Part 2 type B  
DIN 4102 B1  
EN 1021-1/2  
EN 13501-1, B-s1, d0  
IMO FTP Code 2010: Part 8  
NF D60-013  
NF P92 507 M1  
NFPA 701  
ÖNORM B1/Q1  
SN 198 898 5.2  
UNI 9175 Classe 1 IM  
UNI 9177 Classe 1  
US CA TB 117-2013

Velvet / Velluto

---



G230



G231



G232



G233



G234

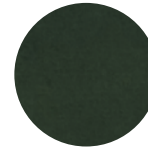

G235



G236



G237



G238



G239

- **FLAME RESISTANCE / RESISTENZA AL FUOCO**  
BS 5852 Part 1  
US CA TB 117-2013

## Category H

Fire retardant simil leather / Finta pelle ignifuga

---



H82



H85



H87

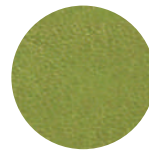

H89

- **FLAME RESISTANCE / RESISTENZA AL FUOCO**  
BS 5852-1 cigarette test  
BS 5852-1 match test  
BS 5852 crib 5  
EN 1021-1  
EN 1021-2  
IMO FTP CODE 2010  
US CA TB 117:2013  
UNI 9175 classe 1IM

Fire retardant simil leather / Finta pelle ignifuga



H30

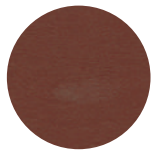

H29



H28



H27



H24



H22

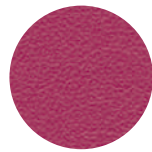

H23



H21

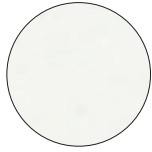

H20

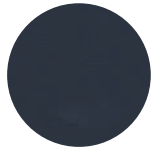

H26



H31



H32

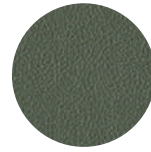

H33



H34

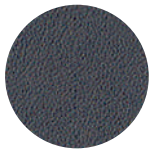

H35



H100



H101



H102



H103



H104

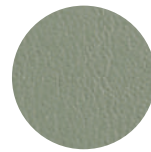

H105



H106

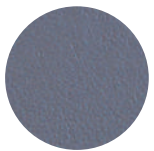

H107



H108

- **FLAME RESISTANCE / RESISTENZA AL FUOCO**  
 BS 5852 Crib 5  
 BS 5852 Part 1-2  
 EN 1021 Part 1-2  
 IMO resolution FTP Code 2010  
 IMO resolution A.652 (16):1989  
 UNI 9175 Classe 1 IM  
 US CA TB 117-2013

Fire retardant fabric / Tessuto ignifugo



H60

- **FLAME RESISTANCE / RESISTENZA AL FUOCO**  
 BS EN 1021 1&2  
 BS EN 1021-1  
 BS 5852 Part 1 0, 1  
 UNI 9175 Classe 1 IM  
 US CA TB 117-2013

Colours are indicative. Pedrali reserves the right to modify or upgrade the product without prior notice.  
 I colori sono indicativi. Pedrali si riserva la facoltà di apportare modifiche o migliorie senza alcun preavviso.



### Fire retardant fabric / Tessuto ignifugo

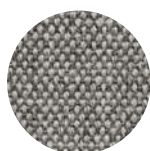

H120

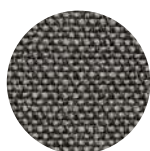

H121

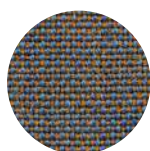

H122

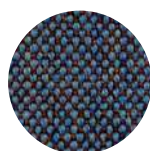

H123



H124



H125

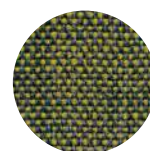

H126

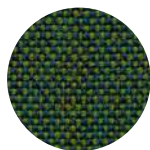

H127

• COLLECTION / COLLEZIONE  
**kvadrat** - REMIX 3  
DESIGNER Giulio Ridolfo

• FLAME RESISTANCE / RESISTENZA AL FUOCO  
AS/NZS 1530.3  
AS/NZS 3837, class 2  
ASTM E84 Class A  
BS 5852 Crib 5 with treatment  
BS 5852 IGNITION SOURCE 3  
BS 5852 Part 1  
EN 1021 - 1/2  
GB 50222 B1 with treatment

IMO FTP Code 2010:Part 7  
with treatment  
IMO FTP Code 2010: Part 8  
NF D60-013  
NFPA 260  
ÖNORM B1/Q1  
SN 198 898 5.3 with treatment  
UNI 9175 Classe 1 IM  
US CA TB 117-2013

### Fabric / Tessuto



H140



H141



H142



H143

• FLAME RESISTANCE / RESISTENZA AL FUOCO  
BS 5852 Crib 5 with treatment  
EN ISO 1021 Part 1  
US CA TB 117-2013



### Fire retardant velvet / Velluto ignifugo



H41

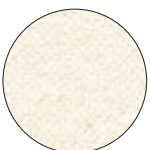

H40



H44



H45



H46

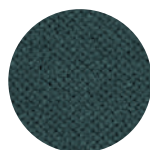

H51

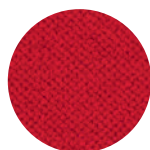

H53

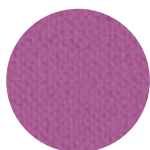

H52



H42



H47



H48



H43

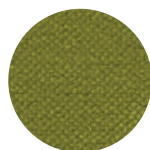

H49

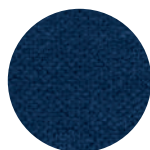

H50

• FLAME RESISTANCE / RESISTENZA AL FUOCO  
BS 5852 Part 0,1  
DIN 4102 B1  
EN 1021-1&2  
IMO MSC 307(88) Annex 1 Part 7-8

NF P 92-503-507 M1  
NFPA 260:2019  
UNI 9177 Classe 1  
UNI 9175 Classe 1 IM  
US CA TB 117-2013

Colours are indicative. Pedrali reserves the right to modify or upgrade the product without prior notice.  
I colori sono indicativi. Pedrali si riserva la facoltà di apportare modifiche o migliorie senza alcun preavviso.



## Category N

Fire retardant fabric / Tessuto ignifugo



N06



N07



N05

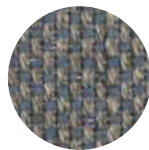

N08

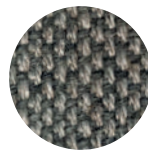

N01

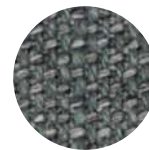

N02

• COLLECTION / COLLEZIONE

**kvadrat** - SUNNIVA

DESIGNER Raf Simons & Fanny Aronsen

• FLAME RESISTANCE / RESISTENZA AL FUOCO

AS/NZS 3837, class 2

BS 5852 Part 1 with treatment

BS 5852 Crib 5 with treatment

EN 1021 - 1/2

NFPA 260

US CA TB 117-2013

IMO FTP Code 2020: Part 8 with treatment

Fire retardant velvet / Velluto ignifugo



N20



N21



N22

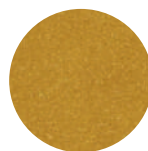

N23

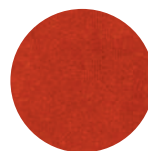

N24

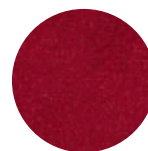

N25

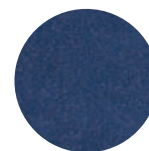

N26

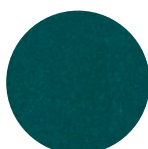

N27

• COLLECTION / COLLEZIONE

**kvadrat** - SAHCO

BALBOA

• FLAME RESISTANCE / RESISTENZA AL FUOCO

BS 5852 Crib 5

BS 5867 Part 2 Type B

DIN 4102 B1

EN 1021-1/2

IMO FTP Code 2010: Part 8

NFPA 701

ÖNORM B1/Q1

SN 198 898 5.2

UNI 9175 1IM

US CA TB 117-2013

Colours are indicative. Pedrali reserves the right to modify or upgrade the product without prior notice.  
I colori sono indicativi. Pedrali si riserva la facoltà di apportare modifiche o migliorie senza alcun preavviso.

Fire retardant fabric / Tessuto ignifugo

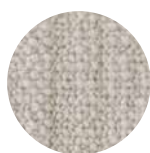

N30

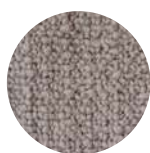

N31



N32

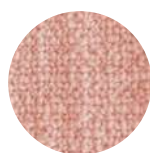

N33

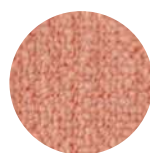

N34

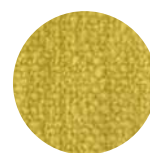

N35

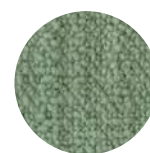

N36

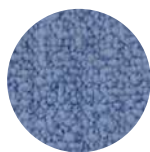

N37

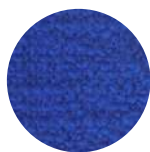

N38

• COLLECTION / COLLEZIONE  
**DEDAR** - A PERFECT FLOWER  
MILANO

• FLAME RESISTANCE /  
RESISTENZA AL FUOCO  
BS 5852 Part 1  
BS 5852 Crib 5  
EN 1021 - 1/2  
UNI 9175 Classe 1 IM  
US CA TB 117-2013

## Category P

Mid grain leather / Pelle mezzo fiore



PBI

PLA

PSA

PGC

PGA

PGR

PBE



PTA

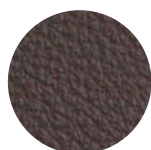

PMA



PNE



PRO



PTE



PGN

• COLLECTION / COLLEZIONE  

 gruppo mastrotto - LINEA

• FLAME RESISTANCE /  
 RESISTENZA AL FUOCO  
 BS 5852:1979  
 BS EN 1021-1-2:2006  
 IMO RES A652 (16)  
 US CA TB 117-2013

Mid grain leather / Pelle mezzo fiore

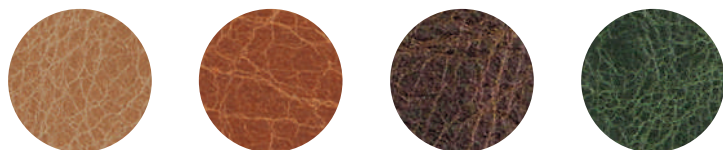

PBS

PCO

PMS

PVE

• COLLECTION / COLLEZIONE  

 gruppo mastrotto - TUSCANIA

• FLAME RESISTANCE /  
 RESISTENZA AL FUOCO  
 BS 5852:1979  
 BS EN 1021-1-2:2006

For Malmö 296, 391, 396, 242, 246 and Inga 5683,  
 5689, 5684, 5685, 5686, 5687, 5681, 5688  
 Per Malmö 296, 391, 396, 242, 246 e Inga 5683, 5689,  
 5684, 5685, 5686, 5687, 5681, 5688

## Category PF

Perforated mid grain leather / Pelle mezzo fiore traforata

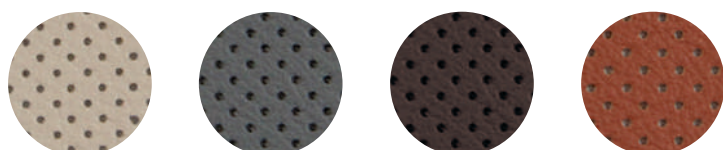

PGCF

PGRF

PMAF

PTEF

• COLLECTION / COLLEZIONE  

 gruppo mastrotto - LINEA

• FLAME RESISTANCE /  
 RESISTENZA AL FUOCO  
 BS 5852:1979  
 BS EN 1021-1-2:2006  
 IMO RES A652 (16)

For Vic and Vic Metal  
 Per Vic e Vic Metal

Colours are indicative. Pedrali reserves the right to modify or upgrade the product without prior notice.  
 I colori sono indicativi. Pedrali si riserva la facoltà di apportare modifiche o migliorie senza alcun preavviso.



---

## PEDRALI PRICELIST | Edition January 2023

Copyright © 2023, Pedrali S.p.A. All rights reserved



The mark of  
responsible forestry

**Look for FSC™ certified products**  
Cerca i prodotti certificati FSC™

**Weights, measurements and colours are indicative. Pedrali reserves the right to modify or upgrade the products without prior notice.**

Pesi, dimensioni e colori sono indicativi. Pedrali si riserva la facoltà di apportare modifiche o migliorie senza alcun preavviso.

**Industrial property right | Diritto di proprietà industriale**

**Pedrali's Collections are worldwide protected by the industrial property right and patents.**

Tutte le collezioni Pedrali sono protette nel mondo dal diritto di proprietà industriale e da brevetti registrati.

